



User's Manual



EZ-1105 / EZ-1305



P/N. 920-013611-01
Rev. A, 08.2009

FCC COMPLIANCE STATEMENT FOR AMERICAN USERS

This equipment has been tested and found to comply with the limits for a CLASS A digital device, pursuant to Part 15 of the FCC Rules. These limits are designed to provide reasonable protection against harmful interference when the equipment is operated in a commercial environment. This equipment generates, uses, and can radiate radio frequency energy and, if not installed and used in accordance with the instructions, may cause harmful interference to radio communications. Operation of this equipment in a residential area is likely to cause harmful interference in which case the user will be required to correct the interference at own expense.

EMS AND EMI COMPLIANCE STATEMENT FOR EUROPEAN USERS

This equipment has been tested and passed with the requirements relating to electromagnetic compatibility based on the standards EN 55022:1998+A1:2000+A2:2003, CISPR 22 , Class A EN 55024:1998+A1:2001+A2:2003, IEC 61000- 4 Series EN 61000-3-2 / 2000 & EN 61000-3-3 / 1995. The equipment also tested and passed in accordance with the European Standard EN55022 for the both Radiated and Conducted emissions limits.

EZ-1105 / EZ-1305 TO WHICH THIS DECLARATION RELATES IS IN CONFORMITY WITH THE FOLLOWING STANDARDS

EN55022 : 1998, CISPR 22, Class A / EN55024 : 1998 IEC 61000-4 Serial / EN61000-3-2 : 2000 / EN 6100-3-3 : 1995 / CFR 47, Part 15/CISPR 22 3rd Edition : 1997, Class A / ANSI C63.4 : 2001 / CNS 13438 / IEC60950-1 : 2001 / GB4943 : 2001 / GB9254 : 1998 / GB17625.1 : 2003 / EN60950-1 : 2001

CAUTION

Danger of explosion if battery is incorrectly replaced
Replace only with the equivalent type recommended by the manufacture.
Dispose of used batteries according to the manufacturer's instructions.

Only use with power supply adapter model: WDS060240 (7A).

Changes or modifications not expressly approved by the party responsible for compliance could void the user's authority to operate the equipment.

Specifications are subject to change without notice.

Safety Instructions

Please read the following instructions seriously.

1. Keep the equipment away from humidity.
2. Before you connect the equipment to the power outlet, please check the voltage of the power source.
3. Disconnect the equipment from the voltage of the power source to prevent possible transient over voltage damage.
4. Don't pour any liquid to the equipment to avoid electrical shock.
5. ONLY qualified service personnel for safety reason should open equipment.
6. Don't repair or adjust energized equipment alone under any circumstances. Someone capable of providing first aid must always be present for your safety
7. Always obtain first aid or medical attention immediately after an injury. Never neglect an injury, no matter how slight it seems.

Safety Instructions

Bitte die Sicherheitshinweise sorgfältig lesen und für später aufheben.

1. Die Geräte nicht der Feuchtigkeit aussetzen.
2. Bevor Sie die Geräte ans Stromnetz anschließen, vergewissern Sie sich, dass die Spannung des Geräts mit der Netzspannung übereinstimmt.
3. Nehmen Sie das Gerät bei Überspannungen (Gewitter) vom Netz. Das Gerät könnte sonst Schaden nehmen.
4. Sollte versehentlich Flüssigkeit in das Gerät gelangen, so ziehen sofort den Netzstecker. Anderenfalls besteht die Gefahr eines lebensgefährlichen elektrischen Schlags.
5. Wartungs- und Reparaturarbeiten dürfen aus Sicherheitsgründen nur von autorisierten Personen durchgeführt werden.
6. Bei Wartungs- und Reparaturarbeiten müssen die Sicherheitsvorschriften der zuständigen Berufsverbände und Behörden unbedingt eingehalten werden.
7. Bei Verletzungen unbedingt den Arzt aufsuchen und die gegebenenfalls die zuständigen Stellen benachrichtigen. Unterlassung kann zum Verlust der Versicherungsleistungen führen.

1. BARCODE PRINTER.....	5
1-1. Printer Accessories.....	5
1-2. General Specifications.....	5
1-3. Communication Interface.....	7
1-4. Printer Parts.....	8
2. PRINTER INSTALLATION.....	10
2-1. Ribbon Installation.....	10
2-2. Label Installation.....	12
2-3. Label Roll Core Installation Instruction.....	13
2-4. PC Connection.....	14
2-5. Driver Installation.....	15
3. PRINTER SETTING.....	17
3-1. FEED Key.....	17
3-2. LED Status.....	17
3-3. Auto Sensing.....	17
3-4. Self-Test page.....	18
3-5. Error Messages.....	19
4. ACCESSORY.....	20
4-1. RS-232 Module Installation.....	20
4-2. Ethernet Module Installation.....	22
5. MAINTENANCE AND ADJUSTMENT.....	25
5-1. Thermal Print Head Cleaning.....	25
5-2. Thermal Print Head Balance Adjustment.....	25
5-3. Print Line Adjustment.....	26
5-4. Troubleshooting.....	27

1. Barcode Printer

1-1. Printer Accessories

After unpacking, please check the accessories that come with the package, and store appropriately.

- ◆ Barcode printer
- ◆ Power cord
- ◆ Switching Power
- ◆ USB Cable
- ◆ Empty Ribbon Roll
- ◆ Label Roll Core
- ◆ Label Stop Plate
- ◆ Quick Start Guide
- ◆ CD (includes label editing software QLabel IV / Manuals)

1-2. General Specifications

Model	EZ-1105	EZ-1305
Print Method	Thermal Transfer / Direct Thermal	
Resolution	203 dpi (8 dot/mm)	300 dpi (12 dot/mm)
Print Speed	4 IPS (100 mm/s)	3 IPS (76.2 mm/s)
Print Width	4.25" (108 mm)	4.16" (105.7 mm)
Print Length	Min. 0.39" (10 mm); Max. 68" (1727 mm)	Min. 0.39" (10 mm); Max. 30" (762 mm)
Memory	4MB Flash (2MB for user storage) ; 8MB SDRAM	
Sensor Type	Fixed transmissive sensor and reflective sensor.	
Media	Types: Continuous form, gap labels, black mark sensing, and punched hole; label length set by auto sensing or programming Width: 1" (25.4 mm) Min. - 4.64" (118 mm) Max. Thickness: 0.003" (0.06 mm) Min. - 0.008" (0.20 mm) Max. Label roll diameter: Max. 5" (127 mm) Core diameter: 1", 1.5" (25.4 mm, 38.1 mm)	
Ribbon	Types: Wax, wax/resin, resin Length: 360' (110 m) Width: 1.18" Min - 4.33" (30 mm - 110 mm) Max Ribbon roll diameter.: 1.57" (40 mm) Core diameter: 0.5" (12.7 mm) with notch	
Printer Language	EZPL, GEPL (Godex Eltron® Printer Language)	
Software	Label design software: QLabel-IV (for EZPL only) Driver & DLL: Windows 2000, XP and Vista	
Resident Fonts	Bitmap fonts: 6, 8, 10, 12, 14, 18, 24, 30, 16X26 and OCR A & B Bitmap fonts 90°, 180°, 270° rotatable, single characters 90°, 180°, 270° rotatable Bitmap fonts 8 times expandable in horizontal and vertical directions Scalable fonts 90°, 180°, 270° rotatable	
Download Fonts	Bitmap fonts 90°, 180°, 270° rotatable, single characters 90°, 180°, 270° rotatable Asian fonts 90°, 180°, 270° rotatable and 8 times expandable in horizontal and vertical directions Scalable fonts 90°, 180°, 270° rotatable	
Barcodes	1-D Bar codes: Code 39, Code 93, Code 128 (subset A, B, C), UCC/EAN-128 K-Mart, UCC/EAN-128, UPC A / E (add on 2 & 5), I 2 of 5, I 2 of 5 with Shipping Bearer Bars, EAN 8 / 13 (add on 2 & 5), Codabar, Post NET, EAN 128, DUN 14, HIBC, MSI (1 Mod 10), Random Weight, Telepen, FIM, China Postal Code, RPS 128 and GS1 DataBar 2-D Bar codes: PDF417, Datamatrix code, MaxiCode, QR code and Micro QR code	

Code Pages	CODEPAGE 437, 850, 851, 852, 855, 857, 860, 861, 862, 863, 865, 866, 869, 737 WINDOWS 1250, 1251, 1252, 1253, 1254, 1255 Unicode (UTF8, UTF16)
Graphics	Resident graphic file types are BMP and PCX, other graphic formats are downloadable from the software
Interfaces	USB port (default on)
Control Panel	One Tri-color LED: Power (Green, Orange and Red) Control key: FEED
Power	Auto Switching 100-240VAC, 50-60Hz
Environment	Operation temperature: 41°F to 104°F (5°C to 40°C) Storage temperature: -4°F to 122°F (-20°C to 50°C)
Humidity	Operation: 30-85%, non-condensing. Storage: 10-90%, non-condensing.
Agency Approvals	CE(EMC), FCC Class A, CB, CCC
Dimension	Length: 10" (254 mm) Height: 6.7" (170 mm) Width: 8.8" (224 mm)
Weight	5.5 lbs (2.5Kg) ,excluding consumables
Options	Internal RS-232 card Ethernet 10/100Mbps print server (default off; disables USB when in use) External label roll holder for 10" (250 mm) O.D. label rolls External label rewinder

Specifications are subject to change without notice. All company and/or product names are trademarks and/or registered trademarks of their respective owners.

1-3. Communication Interface

USB Interface

Connector Type : Type B

PIN NO.	1	2	3	4
FUNCTION	VBUS	D-	D+	GND

Serial Interface (Optional)

Serial Default : 9600 baud rate, no parity, 8 data bits, 1 stop bit, XON/XOFF protocol and
Setting : RTS/CTS ◦

RS232 HOUSING (9-pin to 9-pin)

DB9 SOCKET			DB9 PLUG
---	1	1	+5V,max 500mA
RXD	2	2	TXD
TXD	3	3	RXD
DTR	4	4	N/C
GND	5	5	GND
DSR	6	6	RTS
RTS	7	7	CTS
CTS	8	8	RTS
RI	9	9	N/C
PC			PRINTER

【Note】

The total current output from parallel port and serial port altogether can not exceed 500mA.

1-4. Printer Parts

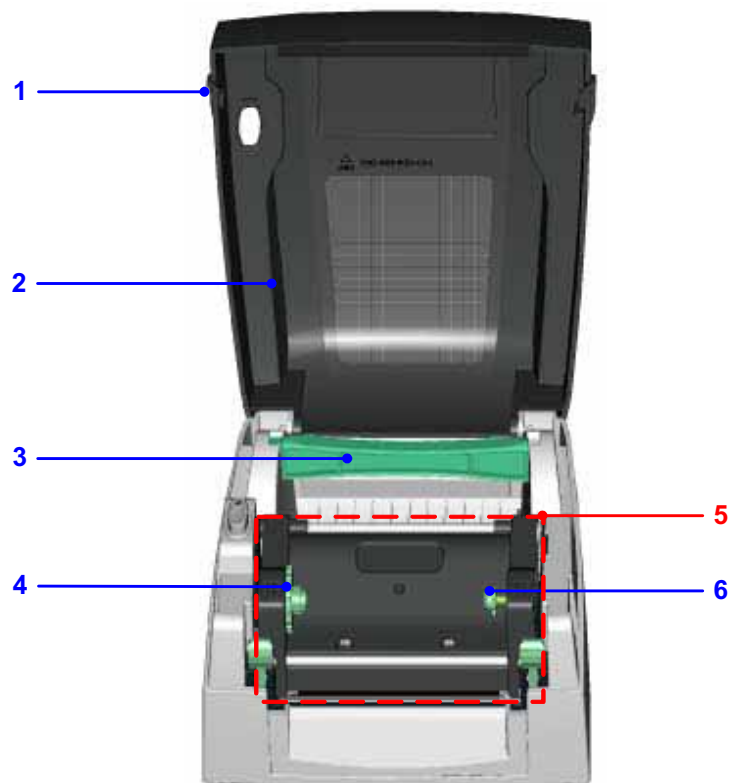

1.	Cover Open Button
2.	Top Cover
3.	Label Roll Core
4.	Ribbon Rewind Wheel
5.	Print Mechanism
6.	Ribbon Core Holder (rewind)

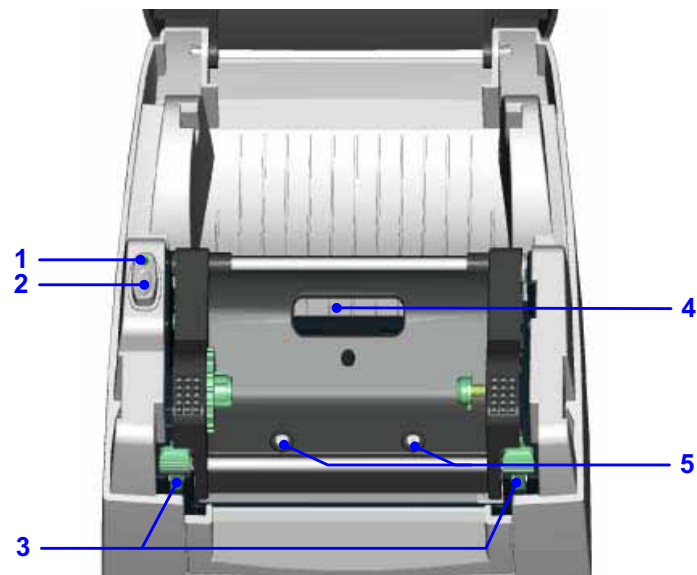

1.	LED Light
2.	FEED Key
3.	Locking Tenon (left/right)
4.	Ribbon Observing Window
5.	Print Head Pressure Adjustment Screw (left/right)

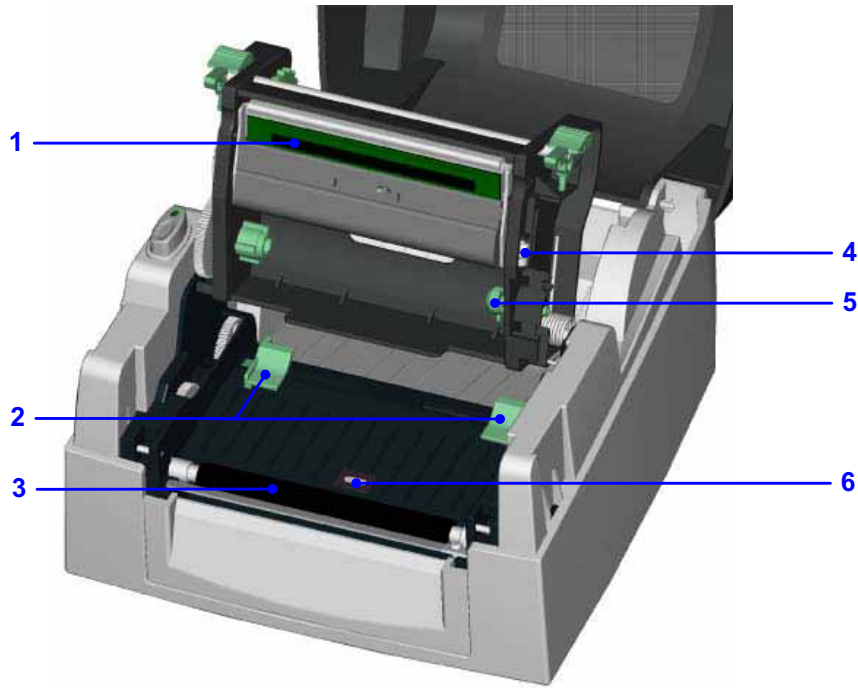

1.	Thermal Print Head
2.	Label Guide
3.	Platen Roller
4.	Print Line Adjustment Gear
5.	Ribbon Core Holder (supply)
6.	Label Sensor



1.	Fan-Fold Label Insert
2.	Power Switch
3.	Power Socket
4.	USB Port
5.	Ethernet Socket (Optional)
6.	Serial Port / RS-232 (Optional)

* The communication ports may vary depending on product types.

2. Printer Installation

This printer model has the following print modes:

Thermal Transfer (TT)	When printing, ribbon must be installed to transfer the print contents onto the media.
Direct Thermal (DT)	When printing, no ribbon is necessary; it only requires direct thermal media.

Please check which print mode you will use and then go into the Setting Mode to change the print mode setting if necessary.

2-1. Ribbon Installation

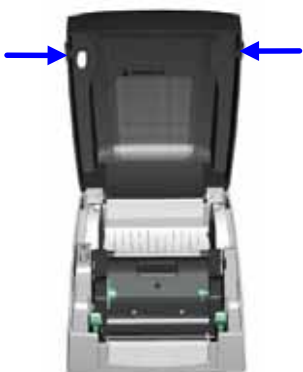
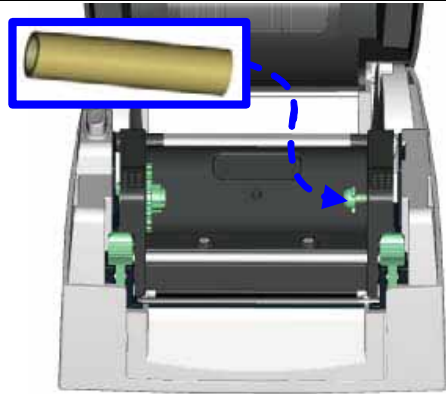
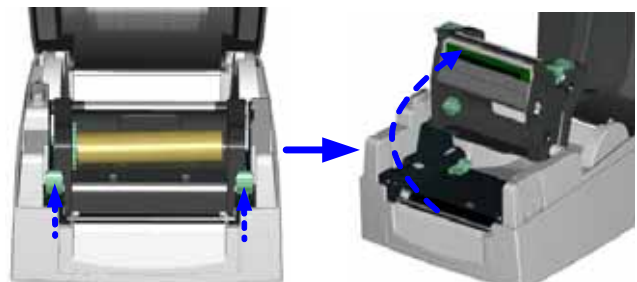
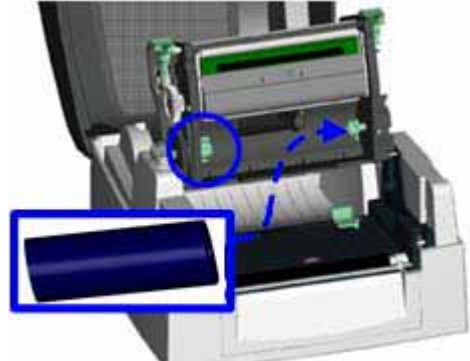
<p>1. Place the printer on a horizontal surface and open the top cover by pressing the Cover Open Buttons on both sides.</p>	
<p>2. Install the rewind ribbon roll from the right side of printer and then fix it on left side.</p>	
<p>3. Press the locking tenons and then lift up the Printing Mechanism.</p>	
<p>4. Place a new ribbon roll from the right side of printer and then fix it on left side.</p> <p>【Note】 Please align the Ribbon Supply Wheel with the fillister of ribbon roll core when installing the ribbon roll. You can rotate the black gear as figure showed to help to align the ribbon roll core.</p>	

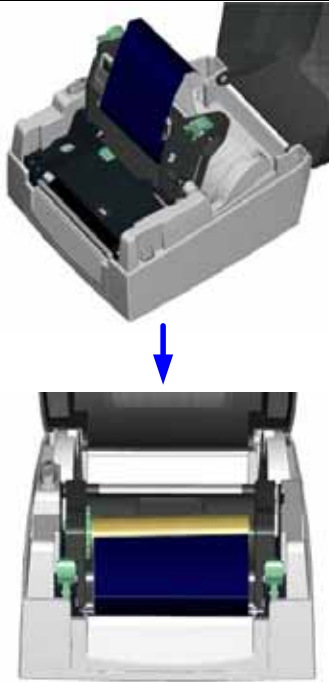
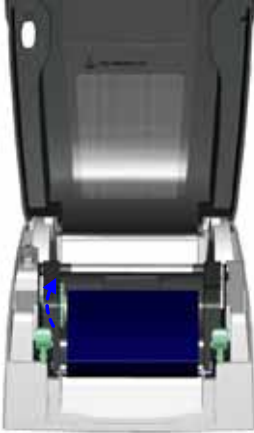
<p>5. Feed the ribbon from the Ribbon Supply Shaft.</p> <p>6. Wrap the ribbon around the Printing Mechanism and stick the ribbon onto the rewind ribbon roll.</p>	 <p>The diagram consists of two parts. The top part shows a top-down view of the printer's internal mechanism with a blue ribbon being inserted from the top. A blue arrow points downwards to the second part, which shows a front view of the printer with the blue ribbon wrapped around the printing mechanism and the rewind ribbon roll.</p>
<p>7. Rotate the Ribbon Rewind Wheel to make the ribbon tight and smooth.</p> <p>8. Firmly close the Printing Mechanism to complete the installation.</p>	 <p>The diagram shows a front view of the printer with the printing mechanism closed. The blue ribbon is visible, having been installed and tightened. A blue arrow points to the left, indicating the direction to rotate the ribbon rewind wheel.</p>

2-2. Label Installation

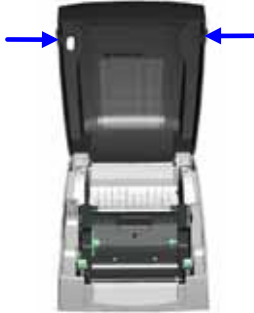
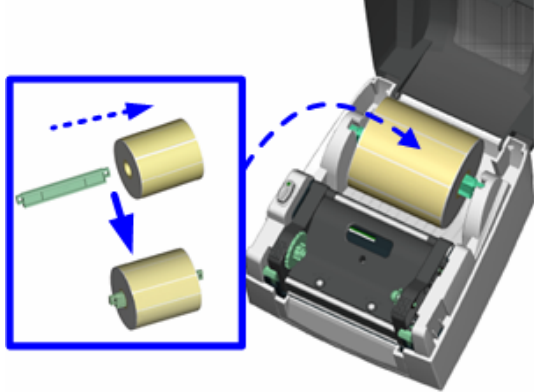
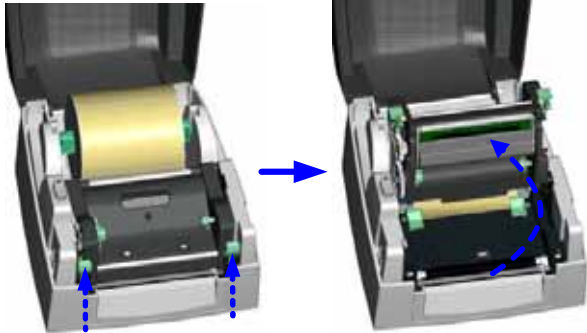
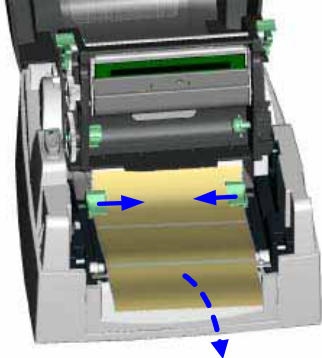
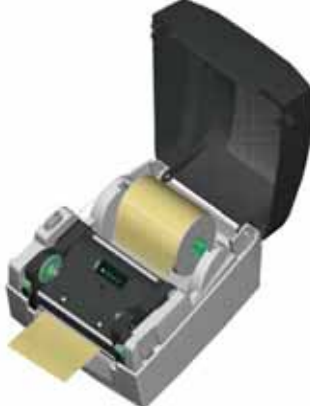
<p>1. Open the top cover by pressing the Cover Open Buttons on both sides.</p>	
<p>2. Place the label roll onto the Label Roll Core.</p>	
<p>3. Press the locking tenons and then lift up the Printing Mechanism.</p>	
<p>4. Feed the label through the two Label Guides to the Tear-off Bar.</p> <p>5. Align the Label Guides to the edge of label.</p> <p><i>【Note】</i> <i>When adjusting the Label Guides, please move both Label Guides together at the same time.</i></p>	
<p>6. Close the Printing Mechanism to complete the label installation.</p>	

2-3. Label Roll Core Installation Instruction

(A) 1" roll core installation

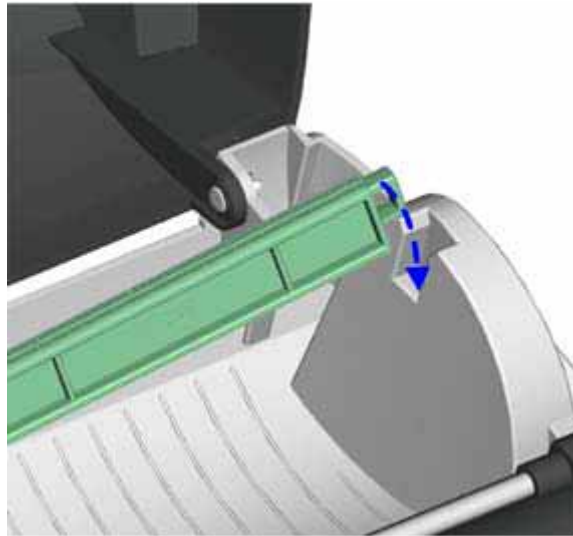
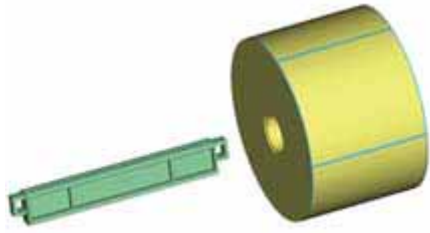

(B) 1.5" roll core installation

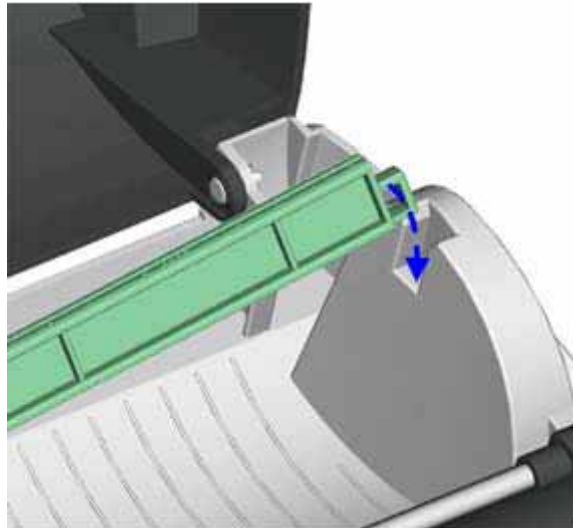
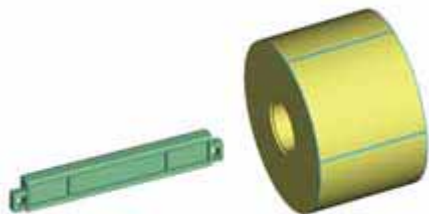

2-4. PC Connection



1. Please make sure the printer is powered off.
2. Plug the power cable into the power socket on the wall, and then connect the other end of the cable to printer's power socket.
3. Connect the cable to the USB port on the printer and on the PC.
4. Turn on the PC and the printer, and then the printer's LED light will shine.

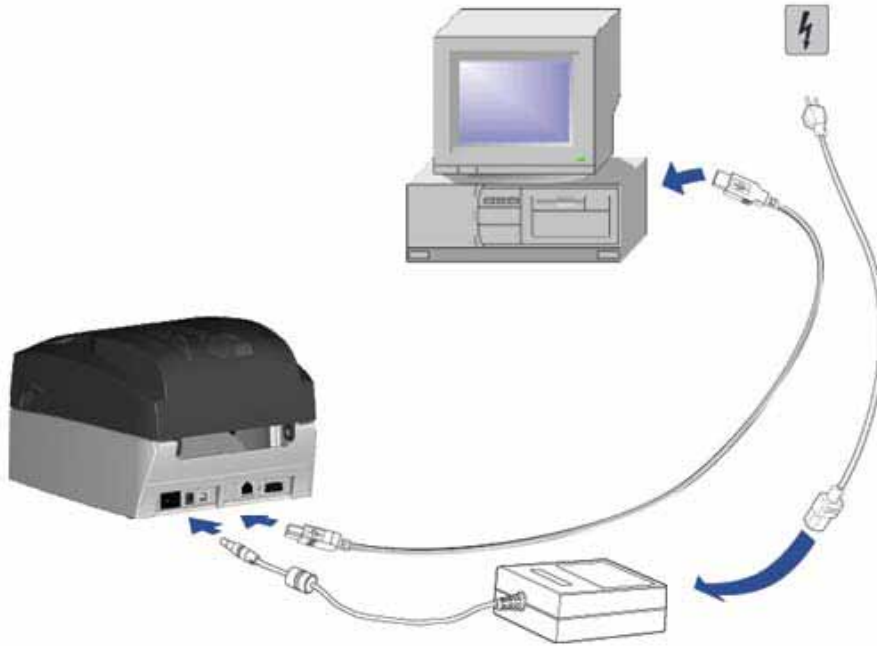

【Note】

Please make sure the power switch is off before plugging the power cable into the printer.

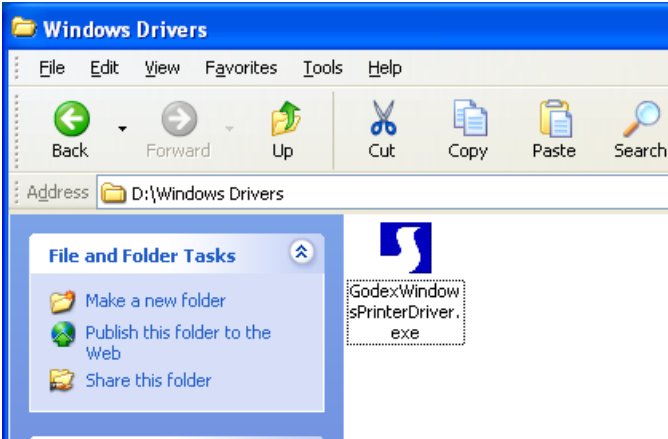

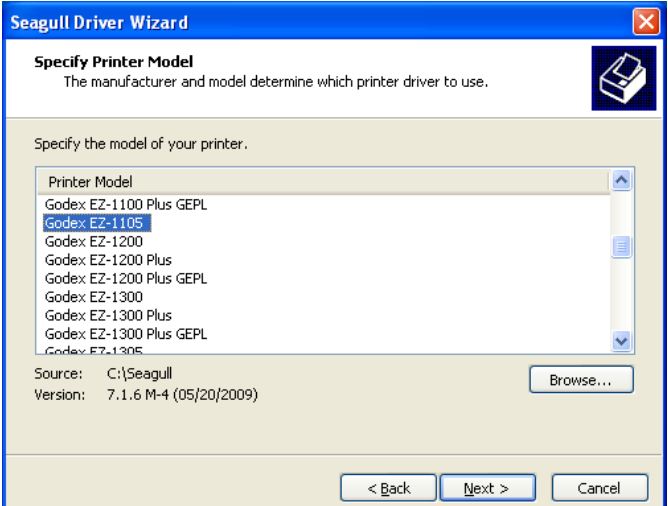
2-5. Driver Installation

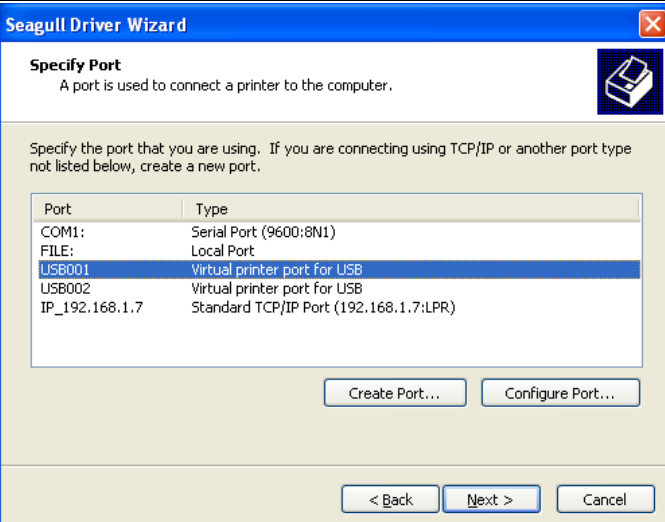
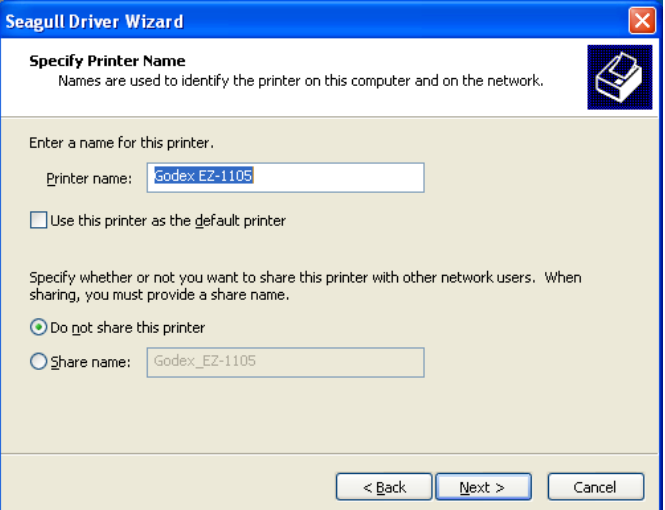
<ol style="list-style-type: none"> 1. Insert the product CD to your computer's CD Drive and find the "Windows Drives" folder. 2. Select the icon of driver file and click it to start the installation. 	
<ol style="list-style-type: none"> 3. Follow the instruction on screen to keep the installation going. Then the Driver Wizard utility should run automatically. 4. Select "Install printer drivers". 	
<ol style="list-style-type: none"> 5. Select printer model. 	

<p>6. Select connection port.</p>	
<p>7. Enter the printer name and set printer sharing option.</p>	
<p>8. A description page of printer settings will be displayed after all settings are completed.</p> <p>9. Check if all printer settings are correct and then press Finish to start copying driver files.</p> <p>10. Wait for file copying finished and complete the installation.</p>	
<p>11. After the driver installation is complete, there should be a new printer model on Windows "Printer and Faxes" setting.</p>	

3. Printer Setting

3-1. FEED Key

After pressing the FEED key, printer will feed the media (according to media type) to the specified stop position. When printing with continuous media, pressing the FEED key will feed the media out to a certain length. When printing with labels, the printer will feed one label each time the FEED key is pressed. If the label is not sent out in a correct position, please proceed with the Auto Sensing (see next section).

3-2. LED Status

**Note: below descriptions are only applied on firmware version G3.000 or after.*

Press and hold the FEED key then power on the printer. Wait for the LED light flashing red and then release the FEED key, the printer will enter into Auto Sensing Mode to do the calibration. A Self-Test page will be printed out automatically after the calibration is completed. Below are the sequence and the description of two modes:

	LED Light	Status	Description
	Green	Standby Mode	Normal status
Press and hold the FEED Key then power on the printer. ↓			
	Red (Flash)	Auto Sensing Mode	Printers are currently in Auto Sensing Mode. The calibration will be performed and a Self-Test page will be printed out to show the configurations of printer. For more detail about Auto Sensing Mode, please refer to next section. For the descriptions of Self-Test page please refer to page 18.

3-3. Auto Sensing

Printer can automatically detect the label and store the result of detecting. By doing this, the printer will calibrate the printing position of the label and the user can do printing without setting the label length. To perform the Auto Sensing, please do as follows:

1. Check if the label is correctly loaded on the printer.
2. Power off the printer, press and hold the FEED key.
3. Power on the printer while still holding the FEED key. Keep holding the FEED key, wait for the LED light turn to flash red and then release the FEED key. Printer will automatically detect the label and record it.
4. A Self-Test page will be printed out after Auto Sensing is completed and the printer goes back to standby mode.

3-4. Self-Test page

The Self-Test page helps user to figure out whether the printer is operating normally. Below are some general descriptions about the content of Self-Test page:

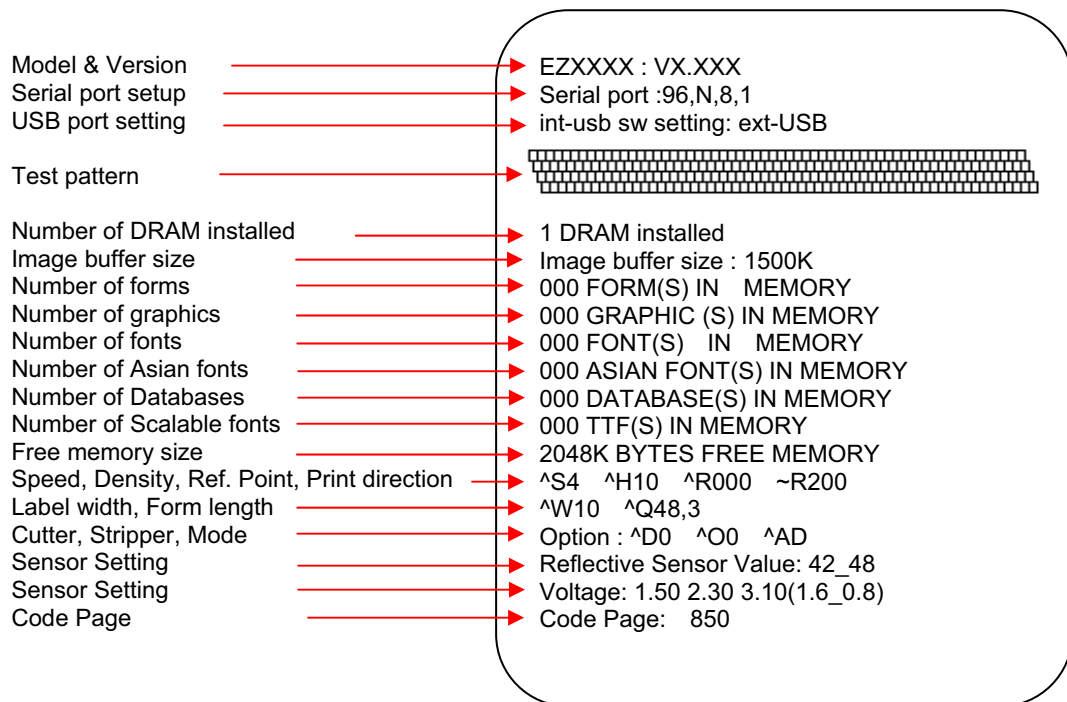







【Note】

For more information about advance settings, such as "Print mode switch", "Sensor switch" or "Dump Mode", please refer to Programmer's manual.

3-5. Error Messages

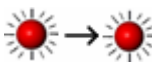
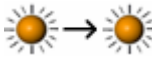
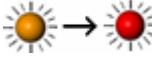

When an error happened during printing process, different LED light messages will be displayed. Users can diagnose the error situation according to the LED light.

Frequency		Quickly blinking		Slowly blinking		Steady
Color		Red light		Orange light		

LED Light	Description		Solution
		Unable to detect the media.	Please perform the Auto Sensing again.
		Media Out	Replace with new label roll or ribbon roll.
	Media Error	Media Jam	Possible causes: card tags or paper fall into the gap behind the platen roller, can't find label gap/black mark, black mark paper out or ribbon out. Please adjust it according to actual usage.
	Print Mode Error	Ribbon is not installed when in Thermal Transfer mode.	1. Please install the ribbon if you want to print in Thermal Transfer mode. 2. Or change the print mode to Direct Thermal mode and print with Direct Thermal media.
	Memory Error	Memory is full; printer will print out "Memory full."	Delete unnecessary data in the memory.
		Can't find the file; printer will print out "Filename can not be found."	Use "~X4" command to print out all the files, and then check whether the file exist and the file name is correct.
		File name is duplicated; printer will print out "Filename is repeated."	Change the file name and download again.
	Print head Error	The temperature of print head is too high.	Wait for the print head temperature drops to the normal temperature range, and then printer will go back to the standby mode and the LED light will stop flashing.

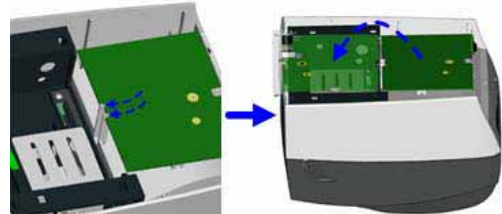
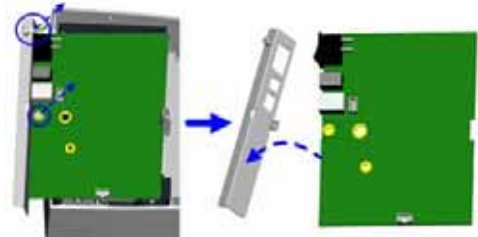
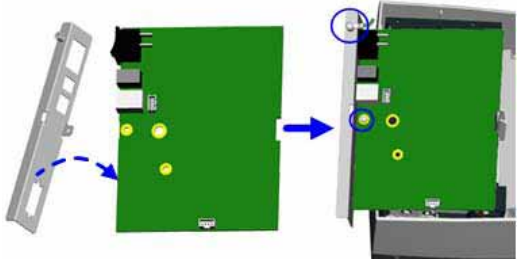
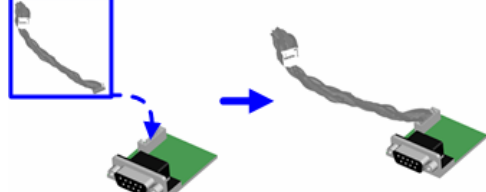

4. Accessory

4-1. RS-232 Module Installation

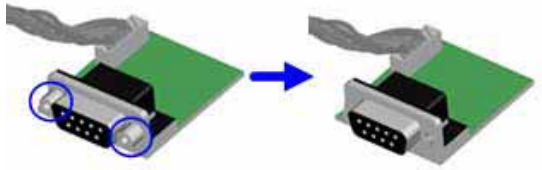
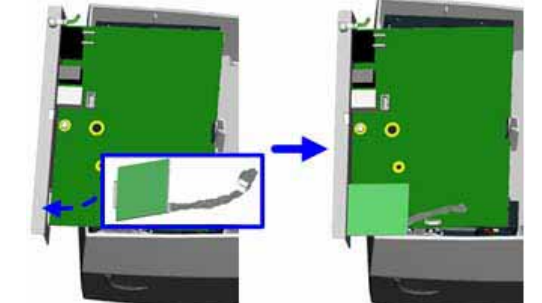
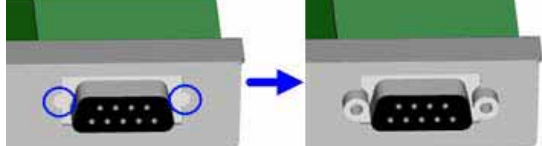
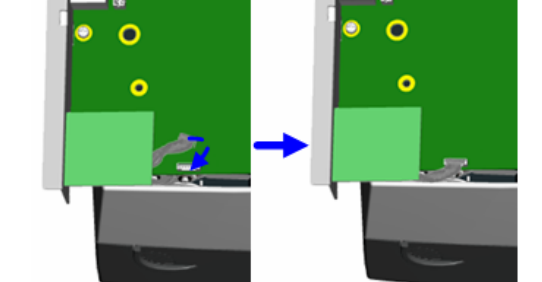
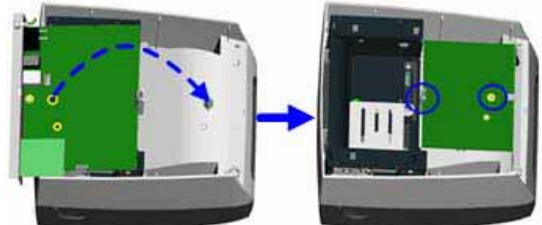
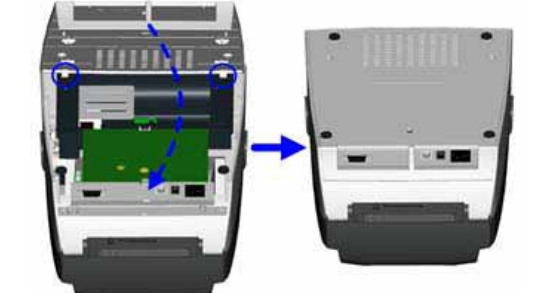
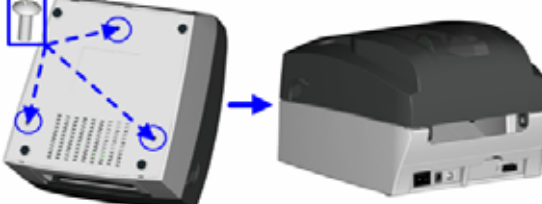
<table border="1"> <tr> <td>1</td> <td>Module Connection Wire</td> </tr> <tr> <td>2</td> <td>RS-232 module</td> </tr> <tr> <td>3</td> <td>Secure Screw</td> </tr> <tr> <td>4</td> <td>RS-232 Back Panel</td> </tr> </table>	1	Module Connection Wire	2	RS-232 module	3	Secure Screw	4	RS-232 Back Panel	
1	Module Connection Wire								
2	RS-232 module								
3	Secure Screw								
4	RS-232 Back Panel								
<p>【Note】 Please make sure that anti-static precautions are adopted during the installation.</p>									
<p>1. Make sure the power is off and the power cable is unplugged. Place the printer onto a smooth surface and flip the whole printer unit upside down.</p> <p>2. Unscrew bottom case screws as indicated in figure.</p>									
<p>3. Push the places as the arrow pointed in figure with both hands. Then move the Bottom Cover upward and remove it.</p>									
<p>4. Push the Mainboard Hooks to release the mainboard and then turn over it to opposite side.</p>									
<p>5. Unscrew the Ground Wire Screw and Mainboard Screw to remove the Connection Port Panel.</p>									
<p>6. Align the RS-232 Back Panel to connection ports and fix it with Ground Wire Screw and Mainboard Screw.</p>									
<p>7. Plug one end of the Module Connection Wire on into the socket on RS-232 module.</p>									

<p>8. Use long-nose pliers to loosen and remove the hexagonal screws on both sides of RS-232 module.</p>	
<p>9. Align the RS-232 module to the RS-232 port and plug into it.</p>	
<p>10. Tighten the hexagonal screws to fix the RS-232 module.</p>	
<p>11. Plug the other end of Module Connection Wire into the socket on mainboard.</p>	
<p>12. Align the hole of mainboard to the pillar and then turn the mainboard back to original position. Push the mainboard downward slightly to fix the mainboard with the hooks.</p>	
<p>13. Align the Bottom Cover to the hooks and reassemble it.</p>	
<p>14. Tighten bottom case screws to complete the installation.</p>	

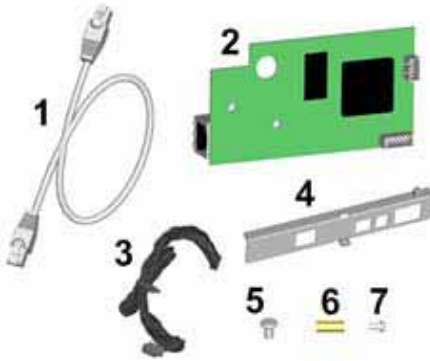
4-2. Ethernet Module Installation

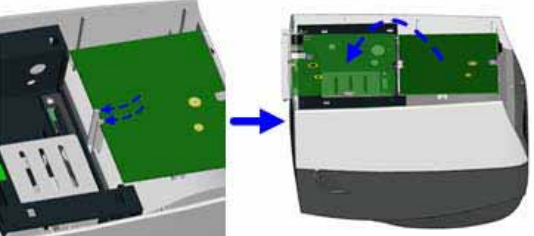
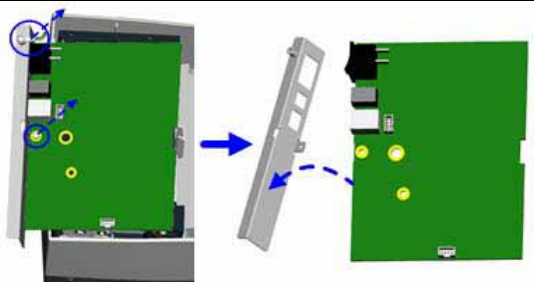
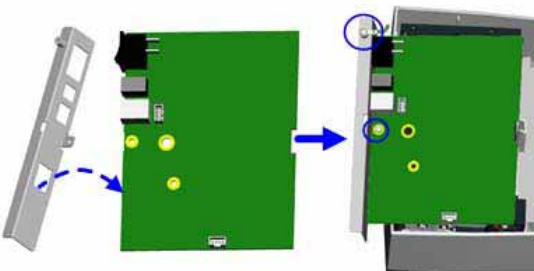
1	Ethernet Cable 1.8M	
2	Ethernet module	
3	Module Connection Wire	
4	Ethernet Back Panel	
5	Secure Screw	
6	Hex Threaded Stand-off	
7	Hex Threaded Stand-off Screw	
<p><i>【Note】</i> <i>Please make sure that anti-static precautions are adopted during the installation.</i></p>		
1.	<p>Make sure the power is off and the power cable is unplugged. Place the printer onto a smooth surface and flip the whole printer unit upside down.</p>	
2.	<p>Unscrew 3 bottom case screws as indicated in figure.</p>	
3.	<p>Push the Mainboard Hooks to release the mainboard and then turn over it to opposite side.</p>	
4.	<p>Unscrew the Ground Wire Screw and Mainboard Screw to remove the Connection Port Panel.</p>	
6.	<p>Align the Ethernet Back Panel to connection ports and fix it with Ground Wire Screw and Mainboard Screw.</p>	

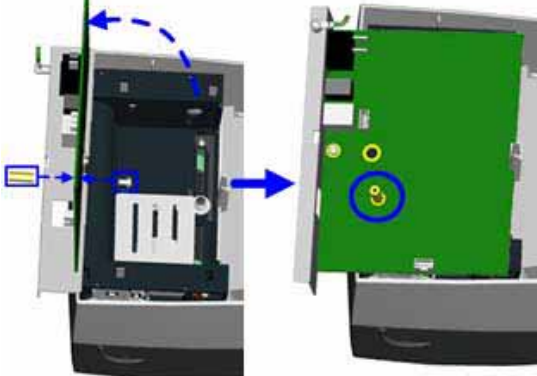
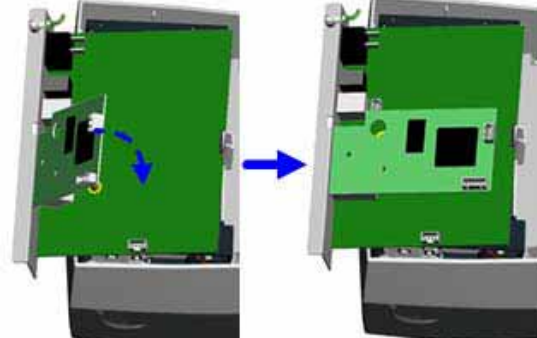
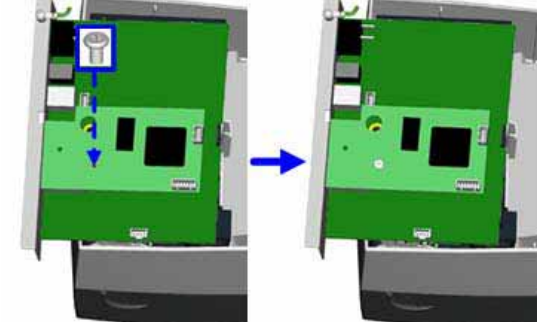
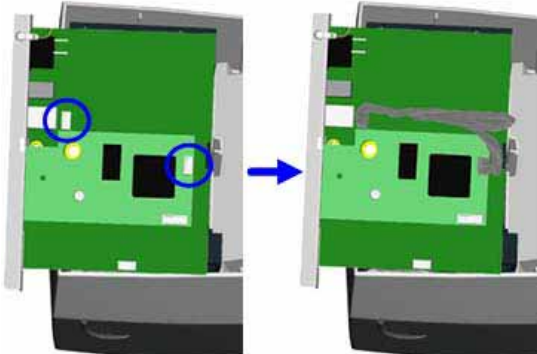
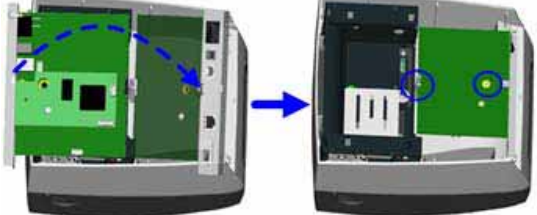
<p>7. Lift up the mainboard. Align the Hex Threaded Stand-off and Hex Threaded Stand-off Screw to each other and tighten as the figure showed.</p>	 <p>The diagram shows two stages of step 7. On the left, a blue dashed arrow indicates the mainboard being lifted upwards. On the right, a blue circle highlights a hex threaded stand-off screw being inserted into a hole on the green mainboard. A blue arrow points from the left image to the right image.</p>
<p>8. Align the Ethernet module to the Ethernet port and plug into it.</p>	 <p>The diagram shows two stages of step 8. On the left, a blue dashed arrow indicates the Ethernet module being moved towards the port. On the right, the module is shown fully inserted into the port. A blue arrow points from the left image to the right image.</p>
<p>9. Tighten the secure screw to fix Ethernet module onto the main board.</p>	 <p>The diagram shows two stages of step 9. On the left, a blue dashed arrow indicates a screw being inserted into a hole on the mainboard. On the right, the screw is shown tightened, securing the Ethernet module. A blue arrow points from the left image to the right image.</p>
<p>10. Connect one end of Module Connection Wire to the main board and the other end to the Ethernet module.</p>	 <p>The diagram shows two stages of step 10. On the left, blue circles highlight the connection points on the mainboard. On the right, a grey wire is shown connecting these points to the Ethernet module. A blue arrow points from the left image to the right image.</p>
<p>11. Align the hole of Ethernet module to the pillar and then turn the mainboard back to original position. Push the mainboard downward slightly to fix the mainboard with the hooks.</p>	 <p>The diagram shows two stages of step 11. On the left, a blue dashed arrow indicates the mainboard being rotated back to its original position. On the right, blue circles highlight the mainboard being pushed down into place. A blue arrow points from the left image to the right image.</p>

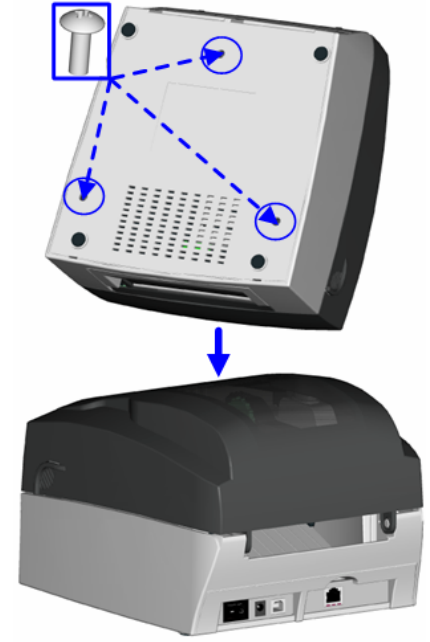
<p>12. Align the Bottom Cover to the hooks and reassemble it.</p>	
<p>13. Tighten bottom case screws to complete the installation.</p> <p>【Note】 After the Ethernet module installation is completed, please send the "<code>^XSET,USBETHERNET,1</code>" printer command to printer for activating the Ethernet connection function. Please mind that USB port will be deactivated once the Ethernet connection function is activated.</p>	

5. Maintenance and Adjustment

5-1. Thermal Print Head Cleaning

Unclear printouts may be caused by dusty print head, ribbon stain or label liner glue. Therefore when printing, it's necessary to keep the top cover closed. Also, check and prevent paper/label from being stained or dusty to ensure print quality and to prolong the print head life. Print head cleaning instructions are as follows:

1. Power-off the printer.
2. Open the top cover.
3. Take out the ribbon.
4. Open the print head by pressing the locking tenons.
5. If on the print head (see blue arrow) there's label pieces or other stain, please use a soft cloth with industrial use alcohol to wipe away the stain.

【Note1】

Weekly cleaning on the print head is recommended.

【Note2】

When cleaning the print head with soft cloth, make sure there is no any metal or hard particles attached on it.

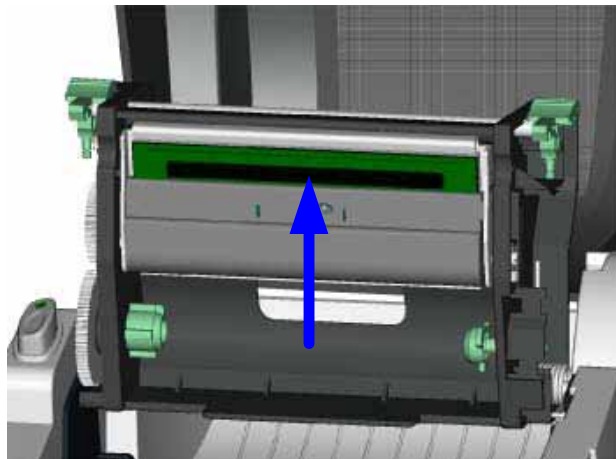

5-2. Thermal Print Head Balance Adjustment

When printing with different label materials or using different ribbon types, unbalanced print quality may occur due to the media material differences, thus it's necessary to adjust the Thermal Print Head pressure.

1. Open the top cover.
2. Take out the ribbon.
3. Turn the print head adjustment screws slightly by screwdriver to increase (turn to "+") or decrease (turn to "-") print head pressure.

【Note】

Please turn the adjustment screws carefully since it may cause worse printing quality or damage on printer.

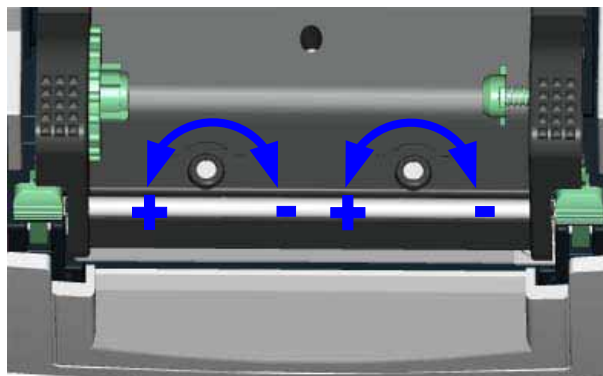

5-3. Print Line Adjustment

To get better printing balance and quality, use print head adjusting gear to adjust the contacting surface between print head and label.

1. When turning print head adjusting gear counter-clockwise (as arrow 1 shows), print line would move in the direction where arrow A shows.
2. When turning print head adjusting gear clockwise (as arrow 2 shows), print line would move in the direction where arrow B shows.

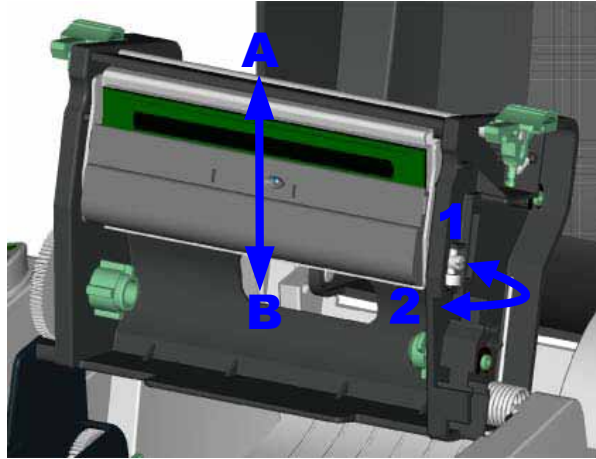

5-4. Troubleshooting

Problem	Recommended Solution
Power on the printer, but the LED does not light up	<ul style="list-style-type: none"> ◆ Check the power connector
LED light turns red (power/status) after printing stops	<ul style="list-style-type: none"> ◆ Check for software setting or program command errors ◆ Replace with suitable label or ribbon ◆ Check if label or ribbon is all out ◆ Check if label is jammed/tangled up ◆ Check if mechanism is not closed(Thermal Print Head not positioned correctly) ◆ Check if sensor is blocked by paper/label
Printing started, but nothing was printed on the label	<ul style="list-style-type: none"> ◆ Check if label is placed upside down or if label is not suitable for the application ◆ Select the correct printer driver ◆ Select the correct label and print type
When printing, label is jammed/tangled up	<ul style="list-style-type: none"> ◆ Clean the label jam, and if label is stuck on Thermal Print Head, please remove it by using soft cloth with alcohol.
When printing, only part of the contents were printed	<ul style="list-style-type: none"> ◆ Check if label or ribbon is stuck on the Thermal Print Head ◆ Check if application software has errors ◆ Check if start position setting has errors ◆ Check if ribbon has wrinkles ◆ Check if ribbon supply shaft is creating friction with the platen roller. If the platen roller needs to be replaced, please contact your reseller for more information ◆ Check if power supply is correct
When printing, part of the label wasn't printed completely	<ul style="list-style-type: none"> ◆ Check if Thermal Print Head is stained or dusted ◆ Use internal command "~T" to check Thermal Print Head can print completely ◆ Check the media quality
Printout not in desired position	<ul style="list-style-type: none"> ◆ Check if sensor is covered by paper or dust ◆ Check if liner is suitable for use, please contact reseller for more information ◆ Check if label roll edge is aligned with Label Width Guide
When printing, page skipping occurs	<ul style="list-style-type: none"> ◆ Check if error occurs on label height setting ◆ Check if the sensor is covered by dust
Unclear printout	<ul style="list-style-type: none"> ◆ Check print darkness setting ◆ Check if Thermal Print Head is covered with glue or stain

【Note】

Your dealer is knowledgeable about printers, printing software, and your unique system. Please contact your local dealer for further technical support.