



Magellan[®] 8100/8100Ω 8200/8200Ω



Model 8204 shown

Product Reference Guide

Datalogic Scanning, Inc.

959 Terry Street
Eugene, Oregon 97402
Telephone: (541) 683-5700
Fax: (541) 345-7140

An Unpublished Work - All rights reserved. No part of the contents of this documentation or the procedures described therein may be reproduced or transmitted in any form or by any means without prior written permission of Datalogic Scanning, Inc. or its subsidiaries or affiliates ("Datalogic" or "Datalogic Scanning"). Owners of Datalogic products are hereby granted a non-exclusive, revocable license to reproduce and transmit this documentation for the purchaser's own internal business purposes. Purchaser shall not remove or alter any proprietary notices, including copyright notices, contained in this documentation and shall ensure that all notices appear on any reproductions of the documentation.

Should future revisions of this manual be published, you can acquire printed versions by contacting your Datalogic representative. Electronic versions may either be downloadable from the Datalogic website (www.scanning.datalogic.com) or provided on appropriate media. If you visit our website and would like to make comments or suggestions about this or other Datalogic publications, please let us know via the "Contact Datalogic" page.

Disclaimer

Datalogic has taken reasonable measures to provide information in this manual that is complete and accurate, however, Datalogic reserves the right to change any specification at any time without prior notice.

Datalogic is a registered trademark of Datalogic S.p.A. and the Datalogic logo is a trademark of Datalogic S.p.A. All licensed to Datalogic Scanning, Inc. All other trademarks and trade names referred to herein are property of their respective owners.

Magellan, FirstStrike and SurroundScan are registered trademarks of Datalogic Scanning, Inc. All-Weights, OmegaTek, Produce Rail, Productivity Index Reporting, SmartSentry and Any-Weights are all trademarks of Datalogic Scanning, Inc.

This product may be covered by one or more of the following patents: 4603262 • 4639606 • 4652750 • 4672215 • 4699447 • 4709369 • 4749879 • 4786798 • 4792666 • 4794240 • 4798943 • 4799164 • 4820911 • 4845349 • 4861972 • 4861973 • 4866257 • 4868836 • 4879456 • 4939355 • 4939356 • 4943127 • 4963719 • 4971176 • 4971177 • 4991692 • 5001406 • 5015831 • 5019697 • 5019698 • 5086879 • 5115120 • 5144118 • 5146463 • 5179270 • 5198649 • 5200597 • 5202784 • 5208449 • 5210397 • 5212371 • 5212372 • 5214270 • 5229590 • 5231293 • 5232185 • 5233169 • 5235168 • 5237161 • 5237162 • 5239165 • 5247161 • 5256864 • 5258604 • 5258699 • 5260554 • 5274219 • 5296689 • 5298728 • 5311000 • 5327451 • 5329103 • 5330370 • 5347113 • 5347121 • 5371361 • 5382783 • 5386105 • 5389917 • 5410108 • 5420410 • 5422472 • 5426507 • 5438187 • 5440110 • 5440111 • 5446271 • 5446749 • 5448050 • 5463211 • 5475206 • 5475207 • 5479011 • 5481098 • 5491328 • 5493108 • 5504350 • 5508505 • 5512740 • 5541397 • 5552593 • 5557095 • 5563402 • 5565668 • 5576531 • 5581707 • 5594231 • 5594441 • 5598070 • 5602376 • 5608201 • 5608399 • 5612529 • 5629510 • 5635699 • 5641958 • 5646391 • 5661435 • 5664231 • 5666045 • 5671374 • 5675138 • 5682028 • 5686716 • 5696370 • 5703347 • 5705802 • 5714750 • 5717194 • 5723852 • 5750976 • 5767502 • 5770847 • 5786581 • 5786585 • 5787103 • 5789732 • 5796222 • 5804809 • 5814803 • 5814804 • 5821721 • 5822343 • 5825009 • 5834708 • 5834750 • 5837983 • 5837988 • 5852286 • 5864129 • 5869827 • 5874722 • 5883370 • 5905249 • 5907147 • 5923023 • 5925868 • 5929421 • 5945670 • 5959284 • 5962838 • 5979769 • 6000619 • 6006991 • 6012639 • 6016135 • 6024284 • 6041374 • 6042012 • 6045044 • 6047889 • 6047894 • 6056198 • 6065676 • 6069696 • 6073849 • 6073851 • 6094288 • 6112993 • 6129279 • 6129282 • 6134039 • 6142376 • 6152368 • 6152372 • 6155488 • 6166375 • 6169614 • 6173894 • 6176429 • 6188500 • 6189784 • 6213397 • 6223986 • 6230975 • 6230976 • 6237852 • 6244510 • 6259545 • 6260763 • 6266175 • 6273336 • 6276605 • 6279829 • 6290134 • 6290135 • 6293467 • 6303927 • 6311895 • 6318634 • 6328216 • 6332576 • 6332577 • 6343741 • 6454168 • 6478224 • 6568598 • 6578765 • 6705527 • 6974084 • 6991169 • 7051940 • AU703547 • D312631 • D313590 • D320011 • D320012 • D323492 • D330707 • D330708 • D349109 • D350127 • D350735 • D351149 • D351150 • D352936 • D352937 • D352938 • D352939 • D358588 • D361565 • D372234 • D374630 • D374869 • D375493 • D376357 • D377345 • D377346 • D377347 • D377348 • D388075 • D446524 • EP0256296 • EP0260155 • EP0260156 • EP0295936 • EP0325469 • EP0349770 • EP0368254 • EP0442215 • EP0498366 • EP0531645 • EP0663643 • EP0698251 • GB2252333 • GB2284086 • GB2301691 • GB2304954 • GB2307093 • GB2308267 • GB2308678 • GB2319103 • GB2333163 • GB2343079 • GB2344486 • GB2345568 • GB2354340 • ISR107546 • ISR118507 • ISR118508 • JP1962823 • JP1971216 • JP2513442 • JP2732459 • JP2829331 • JP2953593 • JP2964278 • MEX185552 • MEX187245 • RE37166 • Other Patents Pending

TABLE OF CONTENTS

Manual Overview	1-2
How to Use This Manual	1-3
Manual Conventions	1-3
Scanner and Scanning-Scale Nomenclature	1-4
Connectors	1-5
Physical Parameters	1-6
Scanning	1-6
Weighing	1-6
Rated Weight Capacity	1-6
Minimum Increment	1-6
Maximum Static Weight (Overload)	1-6
Automatic Zero Maintenance	1-7
Warm-Up Time	1-7
Thermal Equilibrium	1-7
Power-up	1-7
User Configurable Warm-up	1-7
Electrical Specifications	1-9
Power Supply	1-9
Laser and Product Safety	1-10
Labeling	1-12
Bar Codes Supported	1-14
Pre-Installation Considerations	2-2
Checkstand Design	2-3
Scanner Installation	2-4
Scanner Maintenance	2-4
Ergonomic References	2-4
Scanner Usage	2-4
Site Preparation Overview	2-5
Ventilation and Spacing	2-7
Service Access	2-8
Power Installation	2-9
Grounding	2-9
Checkstand Preparation	2-10
Liquid Spills and Moisture	2-10
Counter Cutout	2-11

Checkstand Mounting	2-17
Installation Overview	2-17
Unpacking	2-17
Operational Verification	2-19
Diagnostic Modes	2-21
Scanner Diagnostic Mode	2-21
Scale Diagnostic Mode	2-22
Cables & Connections	2-22
Remote Scale Display Placement/Installation	2-24
Lighting Considerations	2-24
Viewing Angle	2-25
Placing and Installing the Remote Scale Display	2-26
(Short Pedestal Base ONLY)	2-26
Changing Weighing Modes	2-29
Set-Up & Installation	2-29
Set-up	2-29
Installation	2-31
System Power-Up Recap	2-33
Scanning Items	3-1
Proper Scanning Technique	3-2
Proper Weighing Technique	3-3
Operational Controls	3-4
Operational Modes	3-4
Power-Up/Selftest & Pre-Operation	3-4
Power-Up/Selftest	3-4
Error Reporting	3-5
Operational Configuration	3-5
Operating Mode	3-6
Normal Operation	3-6
Sleep Mode	3-6
Additional Functions	3-7
Programming	3-7
Diagnostic Mode	3-7
Scanner and Scale Reset	3-7
Scale Adjustments	3-8
Zeroing the Scale	3-8
Calibrating the Scale	3-8

Operational Maintenance	3-10
Vertical Scan Window Replacement	3-11
Horizontal Scan Window Replacement (WRG)	3-13
Power-Up Selftest	4-1
Operational Tests	4-1
Diagnostic Tests	4-2
Diagnostic Procedures	4-2
Error Codes	4-3
Scale Error Reporting	4-6
Flowcharts	4-8
Description of Calibration Sequence	5-2
Motion Test	5-3
Automatic Zero Setting Test	5-3
Preparing the Scanner/Scale for Calibration	5-4
Calibrating the Scale (Pounds & Kilograms)	5-4
Calibration Verification (U.S. Pounds)	5-8
Increasing-Load Test (Phase 1)	5-9
Shift Test	5-9
Increasing- Load Test (Phase 2)	5-11
Blanking Test	5-11
Decreasing-Load Test	5-12
Return to Zero Test	5-12
Calibration Verification (Kilograms)	5-13
Increasing-Load Test (Phase 1)	5-13
Shift Test (Metric)	5-14
Increasing- Load Test (Phase 2)	5-15
Blanking Test	5-16
Decreasing-Load Test	5-17
Return to Zero Test	5-17
Introduction to Label Programming	6-1
Understanding the Basics	6-1
Integrating the Scanner With Your Host System	6-1
Customizing Your Scanner's Operation	6-2
Programming Overview	6-3
Programming via Handheld Device	6-3
What Is Programming Mode?	6-4
Entering and Exiting Programming Mode.	6-4

Programming Session	6-5
Programming Sequence	6-7
LED and Beeper Indicators	6-9
If You Make a Mistake... ..	6-9
Return to Factory Settings	6-9
Test Mode	6-10
General Scanner and Scale Features	6-11
Double Read Timeout	6-11
Laser Timeout	6-13
Motor Timeout	6-15
Green LED Idle State	6-18
Scanner Button Options	6-19
Power-up Beep Control	6-21
Good Read Beep Control	6-23
Good Read Beep Frequency	6-24
Good Read Beep Length	6-26
Good Read Beep Volume	6-27
Good Read When to Indicate	6-30
Scale Enable	6-32
Scale Country Mode	6-33
Scale Enforced Zero Return	6-35
Scale Interface Type	6-37
Scale Motion Level Filter	6-39
Scale LED Enable	6-41
Remote Display — Enable/Disable	6-42
EAS Active State	6-43
EAS Timeout	6-44
Aux Port Mode	6-45
Productivity Index Reporting (PIR)	6-47
Interface Related Features	6-48
Interface Type	6-48
RS-232 Interface Selection	6-50
RS-232 Wincor-Nixdorf Interface Selection	6-51
RS-232 Single Cable Interface Selection	6-52
IBM Port 17 Interface Selection	6-53
IBM USB Interface Selection	6-54
Maximum Host-Transmitted Message Length	6-55

Number of Host Transmission Buffers	6-56
Global Prefix	6-57
Global Suffix	6-59
IBM Features	6-61
IBM Interface Options	6-61
IBM Scale Address	6-62
IBM Transmit Labels in Code 39 Format	6-64
IBM USB Interface Options	6-65
IBM USB Scanner Device Type	6-67
RS-232 Features	6-68
RS-232 Baud Rate	6-68
RS-232 Number of Data Bits	6-72
RS-232 Number of Stop Bits	6-73
RS-232 Parity	6-74
RS-232 Hardware Control	6-76
RS-232 Intercharacter Delay	6-78
RS-232 Software Flow Control	6-79
RS-232 Host Echo	6-80
RS-232 Host Echo Quiet Interval	6-81
RS-232 Ignore Host Commands	6-82
RS-232 TTL	6-83
RS-232 TTL Invert	6-84
RS-232 Beep on ASCII BEL	6-85
RS-232 Beep After Weigh	6-86
RS-232 Beep on Not on File	6-87
RS-232 ACK NAK Enable	6-88
RS-232 ACK Character	6-90
RS-232 NAK Character	6-91
RS-232 Retry on ACK NAK Timeout	6-92
RS-232 ACK NAK Timeout Value	6-93
RS-232 ACK NAK Retry Count	6-94
RS-232 ACK NAK Error Handling	6-95
RS-232 Label ID Control	6-97
Single Cable RS-232 Options	6-99
Single Cable RS-232 Scanner Only Protocol	6-100
Single Cable RS-232 RTS CTS Selection	6-101
Single Cable RS-232 Use BCC	6-104

Single Cable RS-232 Use ACK/NAK	6-105
Single Cable RS-232 Use STX	6-106
Set Single Cable RS-232 STX Character	6-107
Single Cable RS-232 Use ETX	6-108
Set Single Cable RS-232 ETX Character	6-109
Single Cable RS-232 Datalogic Extensions	6-110
Symbology Programming	6-111
UPC-A Enable	6-111
UPC-A Number System Character Transmission	6-112
UPC-A Check Character Transmission	6-113
Expand UPC-A to EAN-13	6-114
UPC/EAN AIM ID	6-115
UPC-A Label ID	6-116
UPC-A 2-Digit Supplemental Label ID	6-117
UPC-A 5-Digit Supplemental Label ID	6-118
UPC-A 128 Supplemental Label ID	6-119
UPC-E Enable	6-120
UPC-E Number System Character Transmission	6-121
UPC-E Check Character Transmission	6-122
Expand UPC-E to UPC-A	6-123
Expand UPC-E to EAN-13	6-124
UPC-E Label ID	6-125
UPC-E 2-Digit Supplemental Label ID	6-126
UPC-E 5-Digit Supplemental Label ID	6-127
UPC-E 128 Supplemental Label ID	6-128
EAN-13 Enable	6-129
EAN-13 First Character Transmission	6-130
EAN-13 Check Character Transmission	6-131
EAN-13 ISBN Conversion Enable	6-132
EAN 13 Label ID	6-133
EAN-13 2-Digit Supplemental Label ID	6-134
EAN-13 5-Digit Supplemental Label ID	6-135
EAN-13 128 Supplemental Label ID	6-136
Bookland AIM ID	6-137
Bookland Label ID	6-138
EAN-8 Enable	6-139
EAN-8 Check Character Transmission	6-140

Expand EAN-8 to EAN-13	6-141
EAN 8 Label ID	6-142
EAN-8 2-Digit Supplemental Label ID	6-143
EAN-8 5-Digit Supplemental Label ID	6-144
EAN-8 128 Supplemental Label ID	6-145
EAN-8 Decoding Levels	6-146
Other UPC/EAN Options	6-149
UPC/EAN Reconstruction	6-150
Price Weight Check	6-151
Enable EAN Two Label	6-154
Addons	6-155
UPC-A and EAN-13 Decoding Levels	6-157
GTIN Enable	6-160
GTIN Label ID	6-161
GTIN 2-Digit Supplemental Label ID	6-162
GTIN 5-Digit Supplemental Label ID	6-163
GTIN Code 128 Supplemental Label ID	6-164
RSS-14 Enable	6-165
RSS-14 Check Character Transmission	6-166
RSS-14/EAN-128 Emulation	6-167
RSS-14 2D Component Enable	6-168
RSS-14 AIM ID	6-169
RSS-14 Label ID	6-170
RSS Expanded Enable	6-171
RSS Expanded EAN-128 Emulation	6-172
RSS Expanded 2D Component Enable	6-173
RSS Expanded AIM ID	6-174
RSS Expanded Label ID	6-175
RSS Expanded Length Control	6-176
RSS Expanded Maximum Label Length	6-177
RSS Expanded Minimum Label Length	6-178
RSS Expanded Fixed Length 1	6-179
RSS Expanded Fixed Length 2	6-180
Code 39 Enable	6-181
Code 39 Start Stop Character Transmission	6-182
Code 39 Check Character Calculation	6-183
Code 39 Check Character Transmission	6-184

Code 39 Full ASCII	6-185
Code 39 AIM ID	6-186
Code 39 Label ID	6-187
Code 39 Length Control	6-188
Code 39 Maximum Label Length	6-189
Code 39 Minimum Label Length	6-190
Code 39 Fixed Length 1	6-191
Code 39 Fixed Length 2	6-192
Code 39 Stitching	6-193
Pharmacode 39 Enable	6-194
Pharmacode 39 Start Stop Character Transmission	6-195
Pharmacode 39 Check Character Transmission	6-196
Pharmacode 39 Label ID	6-197
Code 128 Enable	6-198
Code 128 Transmit Function Characters	6-199
Convert Code128 to Code 39	6-200
Code 128 AIM ID	6-201
Code 128 Label ID	6-202
Code 128 Length Control	6-203
Code 128 Maximum Label Length	6-204
Code 128 Minimum Label Length	6-205
Code 128 Fixed Length 1	6-206
Code 128 Fixed Length 2	6-207
Code 128 Stitching	6-208
EAN-128 Enable	6-209
EAN 128 AIM ID	6-210
EAN 128 Label ID	6-211
Interleaved 2 of 5 (I 2 OF 5) Enable	6-212
I 2 of 5 Check Character Calculation	6-213
I 2 of 5 Check Character Transmission	6-214
I 2 of 5 AIM ID	6-215
I 2 of 5 Label ID	6-216
I 2 of 5 Length Control	6-217
I 2 of 5 Maximum Label Length	6-218
I 2 of 5 Minimum Label Length	6-219
I 2 of 5 Fixed Length 1	6-220
I 2 of 5 Fixed Length 2	6-221

I 2 of 5 Stitching	6-222
Codabar Enable	6-223
Codabar Start Stop Character Transmission	6-224
Codabar Start Stop Character Set	6-225
Codabar Start Stop Character Match	6-227
Codabar Check Character Calculation	6-228
Codabar Check Character Transmission	6-229
Codabar AIM ID	6-230
Codabar Label ID	6-231
Codabar Length Control	6-232
Codabar Maximum Label Length	6-233
Codabar Minimum Label Length	6-234
Codabar Fixed Length 1	6-235
Codabar Fixed Length 2	6-236
Codabar Stitching	6-237
Code 93 Enable	6-238
Code 93 AIM ID	6-239
Code 93 Label ID	6-240
Code 93 Length Control	6-241
Code 93 Maximum Label Length	6-242
Code 93 Minimum Label Length	6-243
Code 93 Fixed Length 1	6-244
Code 93 Fixed Length 2	6-245
Code 93 Stitching	6-246
MSI/Plessey Enable	6-247
MSI/Plessey Check Character Calculation	6-248
MSI/Plessey Number of Check Characters	6-249
MSI/Plessey Check Character Transmission	6-250
MSI/Plessey AIM ID	6-251
MSI/Plessey Label ID	6-252
MSI/Plessey Length Control	6-253
MSI/Plessey Maximum Label Length	6-254
MSI/Plessey Minimum Label Length	6-255
MSI/Plessey Fixed Length 1	6-256
MSI/Plessey Fixed Length 2	6-257
MSI/Plessey Stitching	6-258
Standard 2 of 5 Enable	6-259

Standard 2 of 5 Check Character Calculation	6-260
Standard 2 of 5 Check Character Transmission	6-261
Standard 2 of 5 AIM ID	6-262
Standard 2 of 5 Label ID	6-263
Standard 2 of 5 Length Control	6-264
Standard 2 of 5 Maximum Label Length	6-265
Standard 2 of 5 Minimum Label Length	6-266
Standard 2 of 5 Fixed Length 1	6-267
Standard 2 of 5 Fixed Length 2	6-268
Standard 2 of 5 Stitching	6-269
Handheld Data Format Requirements General	F-1
Datalogic Handheld Data Format Requirements	F-2
RSS-14	F-2
RSS Expanded	F-2
UPC-A	F-2
UPC-A with 2-Digit Supplemental	F-2
UPC-A with 5-Digit Supplemental	F-3
UPC-A with Code 128 Supplemental	F-3
UPC-E	F-3
UPC-E with 2-Digit Supplemental	F-4
UPC-E with 5-Digit Supplemental	F-4
UPC-E with Code 128 Supplemental	F-4
EAN-8	F-5
EAN-8 with 2-Digit Supplemental	F-5
EAN-8 with 5-Digit Supplemental	F-5
EAN-8 with Code 128 Supplemental	F-5
EAN-13	F-6
EAN-13 with 2-Digit Supplemental	F-6
EAN-13 with 5-Digit Supplemental	F-6
EAN-13 with Code 128 Supplemental	F-6
Code 39	F-7
Code 39-Pharmacode	F-7
I 2 of 5	F-7
Codabar	F-8
Code 128	F-8
MSI/Plessey	F-9
Code 93	F-9

PDF417	F-9
AIM Formats	F-10
UPC-A	F-10
UPC-E	F-10
EAN-13	F-10
EAN-8	F-10
2-Digit Supplemental	F-11
5-Digit Supplemental	F-11
Code 128 Supplemental	F-12
Bookland	F-12
Code 39	F-12
Codabar	F-13
MSI/Plessey	F-13
Code 93	F-13
RSS-14	F-14
RSS Expanded	F-14
I 2 of 5	F-14
Code 128 / EAN128	F-15
PDF417	F-15

NOTES

Section 1

Introduction

This Product Reference Guide contains comprehensive instructions on how to install the scanner or scanning-scale (either model may be termed “scanner” for the purpose of simplicity in this manual), how to program it using special programming feature bar code labels, and advanced user information as described in the following overview.

Manual Overview

Section 1, *Introduction*, presents the manual's contents, describes features and specifications, provides regulatory and safety information, and lists the bar code symbologies the scanner will read.

Section 2, *Site Preparation and Installation*, supplies physical dimensions for the scanner or scanning-scale and its most common accessories, and details counter preparation and installation. Cable routing, connection and testing are also explained in this section.

Section 3, *Operation and Maintenance*, describes use and maintenance; providing details about operator controls, programming and diagnostic modes, scale "zeroing" and calibration. Scanner and scale routine maintenance are outlined in this section as well.

Section 4, *Problem Isolation*, provides an outline of three scanning-scale test modes: Selftest, Operational Tests and Diagnostic Tests. Descriptions of the error indications if the scanner detects a system problem and troubleshooting flowcharts to aid in problem resolution are also presented.

Section 5, *Calibration*, explains scale calibration and verification procedures, including procedures for calibrating the scale in pounds as well as kilograms.

Section 6, *Programming*, details procedures and provides custom bar codes for setting programmable scanner and scanning-scale features. This section is organized by the categories: General Features, Interface Related Features and Symbology Related Features.

Appendix A, *LED/Beeper Indications & Controls*, lists the various functions and indications of the scanning-scale control panel features.

Appendix B, *Cable Information*, outlines wire requirements, connector specifications and pinout details for associated product cabling.

Appendix C, *Keypad*, furnishes bar codes representing the digits and characters required to enter extended programming data needed during certain programming sessions.

Appendix D, *Host Commands*, contains a partial listing of available host commands that can be used with a compatible host interface.

Appendix E, *Factory Defaults*, is a table listing factory defaults for the most common interface types.

Appendix F, *Handheld Data Format Requirements*, is a useful resource.

How to Use This Manual

You'll find it helpful to familiarize yourself with the first section of this manual, since it provides both a general description of the product's features and an overview of the manual's contents and organization. Reference the other sections as required for information about scanner or scanning-scale installation, operation, maintenance, calibration and bar code programming.

Manual Conventions



'NOTE' blocks contain information that is helpful and recommended. They provide information that is critical to operations and/or procedures described in this manual.



'LEGAL NOTE' blocks indicate procedures or activities which may be regulated under law by governmental agencies. It is your responsibility to ensure compliance with the regulations that govern installation of weighing devices.



'CAUTION' blocks inform you that proper handling (adherence to the procedures described) is required to avoid damage to equipment and/or property.



'WARNING' blocks alert you to potential physical harm or injury. These statements do not include potentially fatal hazards, which would be designated as 'DANGER' blocks. Use of this product does not warrant the need for a DANGER block.

Scanner and Scanning-Scale Nomenclature

Controls, indicators and other nomenclature are shown in Figure 1-1.

Figure 1-1. Scanning-Scale Nomenclature

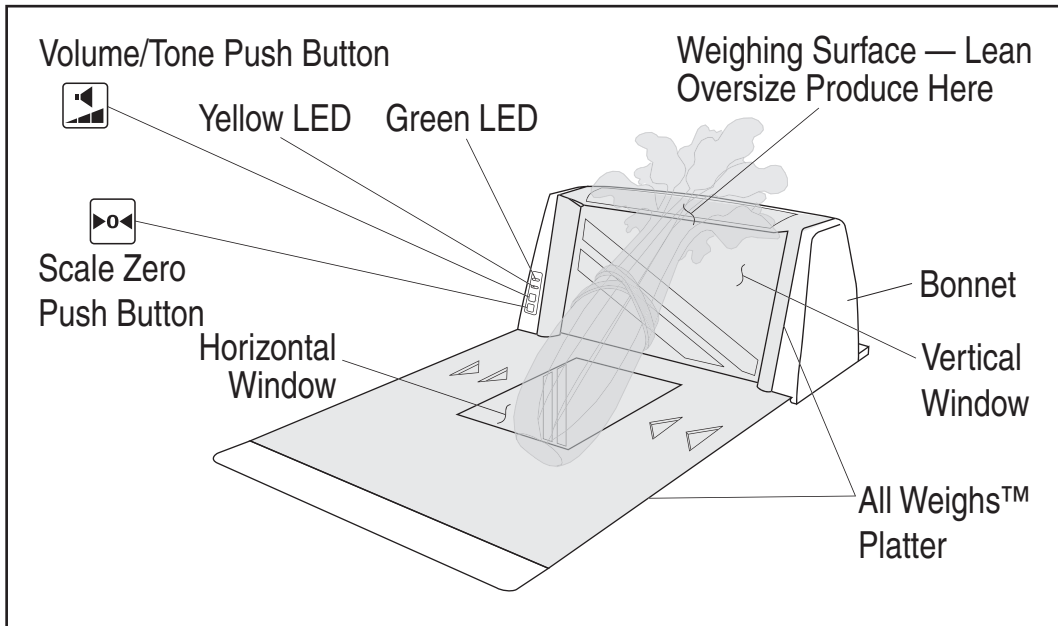

Connectors

The appearance of the connector panel will vary depending upon the factory options purchased with your model. Reference Figure 1-2.

Figure 1-2. Connector Panel

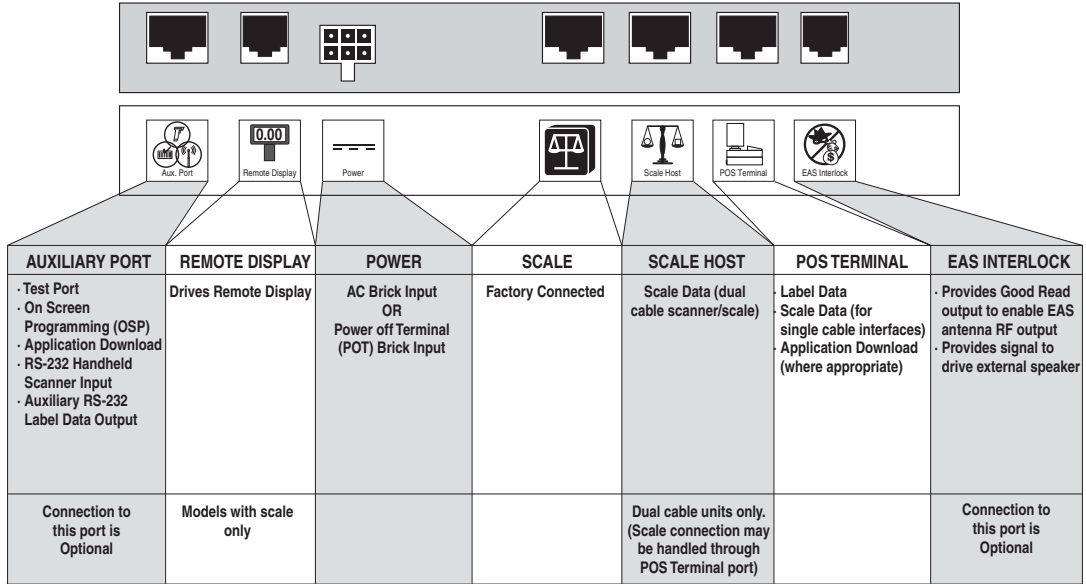
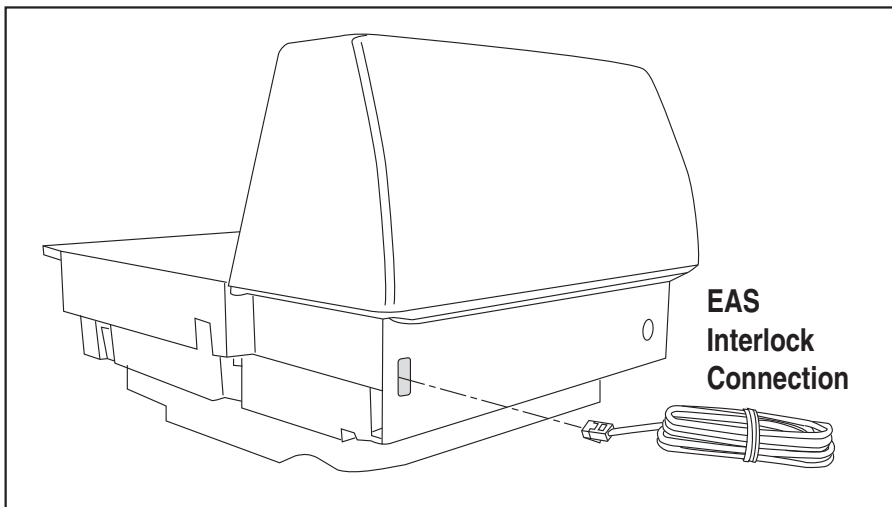

Figure 1-3. Connecting the Optional EAS Interlock Cable



Physical Parameters

This section provides specifications for performance, environmental and electrical parameters. Reference the second section of this manual, *Site Preparation and Installation*, for physical measurements of all models and some accessories.

Scanning

The scanner has a scan zone between the two windows where the scanner projects laser light in order to scan items. Three projections, two from the horizontal window and one from the vertical window, combine to form a zone where bar code labels are read. Refer to the *Operation and Maintenance* section of this manual for more details about the topic: *Scanning Items*.

Weighing

Specifications for scale capacity, settling time, minimum and maximum static weight, zeroing, and warm-up time are given below. For more information regarding the topic: *Proper Weighing Technique*, refer to the *Operation and Maintenance* section of this manual.

Rated Weight Capacity

The scale's operational weight capacity is:

- 30.00 pounds, displayed in 0.01 increments
- OR
- 15.000 kilograms¹, displayed in 0.005 increments.

Minimum Increment

The minimum weight that can be accurately measured by the scale is 0.02 lb. (0.005 kg).

Maximum Static Weight (Overload)

A maximum static weight of 150 pounds (68 kg) can be sustained by the scale without incurring damage or degrading performance.

1. The scale can also be set for 9.99 kg max.

Automatic Zero Maintenance

The scale's software constantly monitors and adjusts the Zero point as long as the deviation is within acceptable limits¹, while compensating for any debris accumulation or removal. During power-up, the scale automatically re-zeros after verifying that all subsystems are functional. Additionally, the scale may be manually "zeroed" by pushing the Scale Zero Push Button located on the top of the vertical enclosure.

Warm-Up Time

There are two pertinent warm-up times that apply to the scanner or scanning-scale:



NOTE

The two warm-up periods can be performed concurrently, thereby reducing the total required warm-up time to 60 minutes.

Thermal Equilibrium

When the unit is moved from a cooler temperature (such as a storage area) to a warmer environment (such as a checkstand location), 60 minutes must be allowed to acclimate the unit to ambient conditions prior to calibration or operation.

Power-up

Once installed and powered up, a warm-up time of 15 minutes must be allowed before calibrating or performing weighing operations.

User Configurable Warm-up

The user may configure the unit for a pre-programmed warm-up time that is activated every time the scanner is powered up. During this time, the scale is viewed by the POS terminal as off-line.

1. Acceptable limits of deviation are set at -0.2 to +0.6 pounds (-0.078kg to 0.23kg), which is -0.67 to +2.0% of total capacity.



Contact technical support to learn more about this advanced programmable feature.

NOTE

Figure 1-4. Environmental Specifications

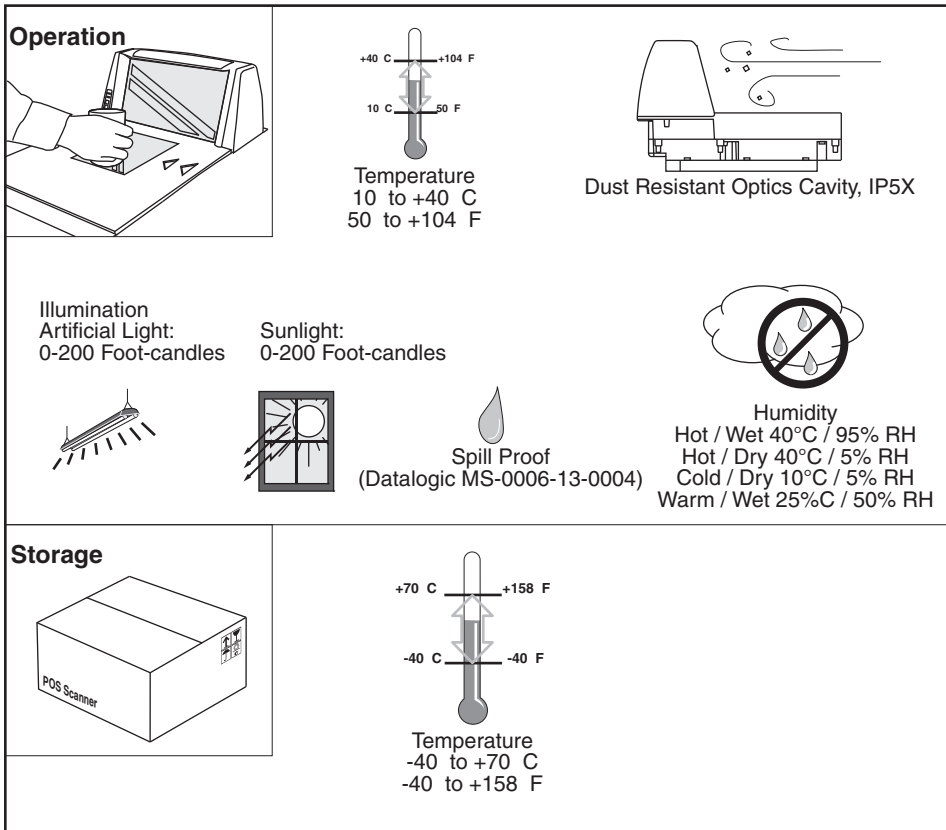

Electrical Specifications

Before installation, always verify that the site's electrical service meets the scanning-scale's requirements. The scanner has been engineered for compatibility with most international electrical systems operating in ranges from 100 to 240VAC at 50-60 Hz. Verify that the power source will supply "clean" electrical power to the equipment; that is, it must be free of excess electrical noise.

Check the IEC power cord shipped with the scanning-scale. If the cord will not plug into your AC power receptacle, the power cord shipped is not compatible with your electrical system. Please contact your distributor immediately to receive the necessary information and components to ensure electrical compatibility.

Power Supply

The scanner utilizes a single power supply for all models. Unique installation and international connections are accomplished through selection of the proper IEC power cord

VOLTAGE
100-240VAC \pm 10%

FREQUENCY
50-60 Hz

CURRENT (RMS)
0.5 Amps @ 100V

PART NUMBER
8-0582



CAUTION

Safe operation of your scanner or scanning-scale requires properly grounded electrical outlets. Be sure to have a qualified electrician certify the earth-ground connection on circuits which will be used to power the unit.



NOTE

The scanner is powered on/off by connecting/disconnecting its AC power supply.

Laser and Product Safety

Laser safety requirements are based on IEC Standard Publication 60825-1 (2001) and CDRH 21CFR, Chapter 1, Subchapter J and (CDRH) Laser Product Performance Standard, User information [1040.10(h)1]:

- **User Maintenance.** No user maintenance of the system other than cleaning of the scan windows is required.
- **Radiant Energy.** The scanner is an IEC Class 1 and CDRH IIa laser product. The system uses two embedded Class 3B Visible Laser Diodes (VLDs) operating at 650.0 or 670.0 nm, in an opto-mechanical scanner, resulting in less than $3.9\mu\text{W}$ radiated power as observed through a 7mm aperture and averaged over 10 seconds. Maximum emitted peak output power at the lower window is $897\mu\text{W}$. No attempt should be made by the user to remove the protective housing of the scanning-scale.
- **Laser Light Viewing.** The horizontal and vertical scan windows are the only apertures through which laser light may be observed in this product.

Exposure to the light emitted from the scan windows has been shown not to be harmful. The safety record of bar code scanning is perfect after millions of hours of use worldwide. This safe and efficient use of laser technology has gained wide acceptance in industries throughout the world.

Operators and installers of the unit should observe the following cautions and warnings:



CAUTION

Use of controls, adjustments or performance of procedures other than those specified herein may result in hazardous laser light exposure.

The use of optical instruments with the scanner will increase eye hazard. (Optical instruments include binoculars, microscopes, telescopes and magnifying glasses. This does not include eyeglasses worn by the user).

To prevent exposure to laser light, do not remove the protective housing of the scanner. There are no user-serviceable parts inside your scanner or scanning-scale.

Safety precautions to be taken:



CAUTION

No adjustments or alteration of the scanner or scanning-scale housing are to be attempted by the user.

The failure of the facet wheel motor while the unit is continuing to emit a laser beam causes the emission levels to exceed those for inherently safe operation. The unit has safeguards to prevent this occurrence. If, however, a stationary laser beam is ever emitted, the failing unit should be disconnected from its power supply until repaired by a qualified technician.



WARNING

This equipment has been tested and found to comply with the limits for a Class A digital device, pursuant to part 15 of the FCC Rules. These limits are designed to provide reasonable protection against harmful interference when the equipment is operated in a commercial environment. This equipment generates, uses, and can radiate radio frequency energy and, if not installed and used in accordance with the instruction manual, may cause harmful interference to radio communications. Operation of this equipment in a residential area is likely to cause harmful interference in which case the user will be required to correct the interference at his or her own expense.

This Class A digital apparatus meets all requirements of the Canadian Interference-Causing Equipment Regulations.

Cet appareil numérique de la classe A respecte toute les exigences du Reglement sur le material brouilleur du Canada.

Labeling

Regulatory, reference and safety labeling is shown in Figure 1-5.

Figure 1-5. Labeling/Agency Compliances

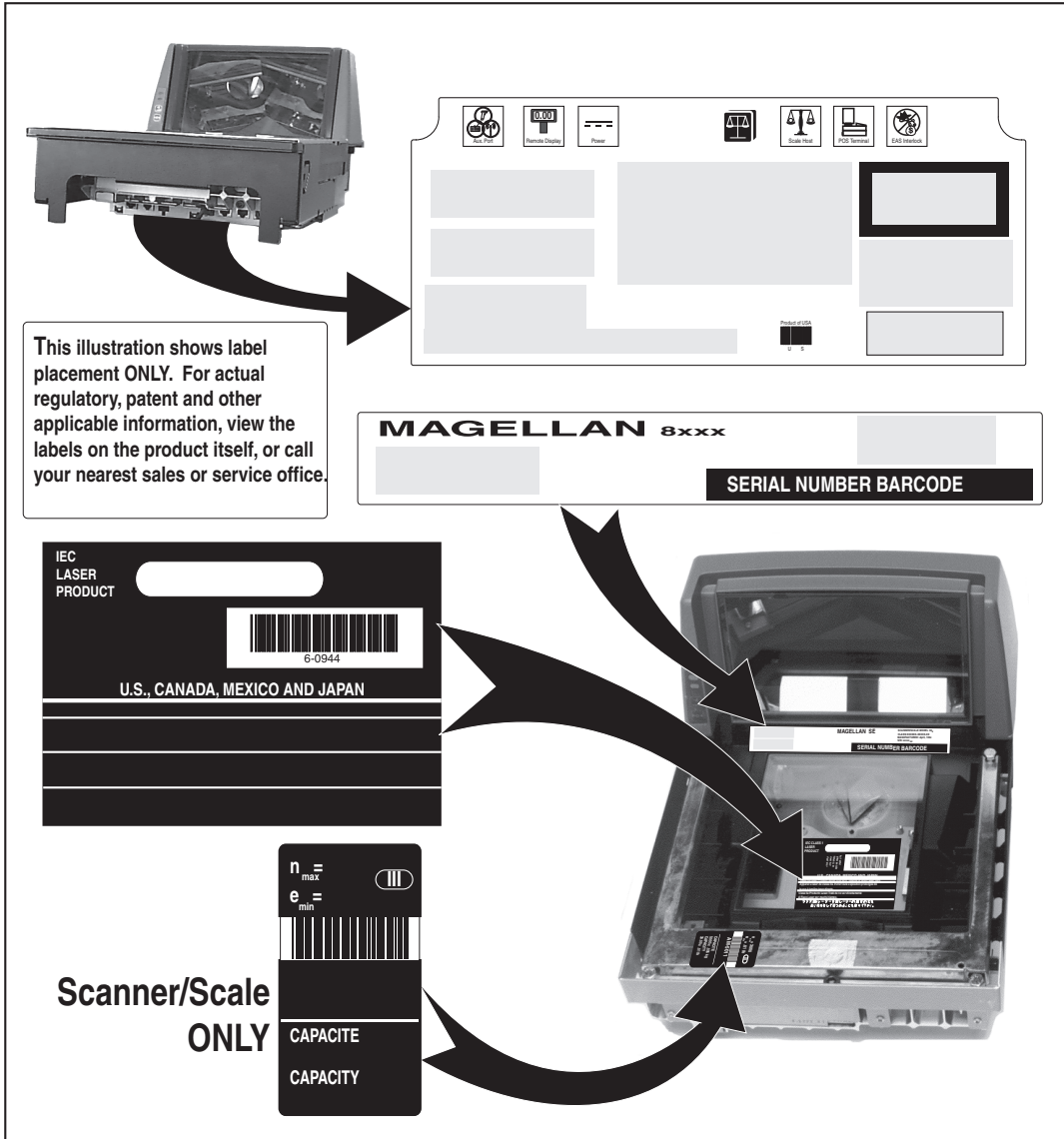

The scanner and scanning-scale meet or exceeds the requirements for their device type as set forth by the following agencies and regulations:

COUNTRY	COMPLIANCE	COMMENTS
Electrical		
United States	UL 1950	TÜV NRTL
Canada	CAN/CSA C22.2 No. 1950	TÜV NRTL
World	IEC60950 / IEC 825-1	TÜV CB
Australia	AS 3260	AS (power adapter)
Japan	MITI T-Mark	(Power adapter)
Emmissions		
United States	47CFR Part 15J	FCC
Canada	ICES-0003	Class B
Europe	EN 55022	Class B
Australia/N Zealand	AS/NZ 3548	Class B
Japan	VCCI	Class B
Taiwan	CNS 13438	Class B
Safety & Emissions	EMC Directive 89/336/EEC LV Directive 73/23/EEC	CE Mark CE Mark
Laser Safety		
United States	CDRH, 21CFR Part 1040	CDRH Class IIa laser device
Canada	same as CDRH	SGM-1 specification
Australia	AS 2211	
Weights & Measures		
United States	NIST Handbook 44	(Dept. of Commerce)
Canada	Measures Canada	
Australia	NSC	
New Zealand	1987 Part 1	Reg. 4, Reg. 4A
Mexico	NOM	NOM-019-SCFI-1994
New York	New York Certificate	
Europe	EN45501 10IML R76	NWML

Contact Datalogic Marketing at (541) 683-5700, or your Datalogic representative for a complete listing of approvals for other countries.

Bar Codes Supported

The scanner can read/decode the following bar code types (symbologies):

- UPC Versions A & E
- UPC Supplementals and Add-ons (2 & 5 digit supplementals, Coupon code and Code 128)
- Plural Stage Dual UPC Bar Codes for Japan (2 label read)
- Reduced Space Symbology (RSS) RSS-14, RSS expanded, RSS Stacked
- EAN-8 & 13
- JAN-8 & 13
- UCC/EAN 128
- Code 39
- Code 39 full ASCII
- Code 128 (including conversion to Code 39)
- Code 93
- Interleaved 2 of 5 (I 2 of 5)
- Italian Pharmacode (Code 39)
- Codabar
- MSI/Plessey

Section 2

Site Preparation and Installation

This section provides a reference for preparing most checkstands to receive the scanner or scanning-scale. Included are physical parameters and instructions for checkstand preparation, power and ventilation considerations, cable routing information and unit installation.

Site Preparation lists all procedures necessary to prepare the checkstand. The instructions that follow, titled *Checkstand Preparation*, detail steps for the three models that are available (shown in Figure 2-1 below) to facilitate easy installation into almost any checkstand application around the world:

Model 8100/8200 — Short Scanner

Model 8103/8203 — Long Scanner

Model 8101/8201 — Medium Scanner

Model 8104/8204 — Long Scanner/Scale

Model 8102/8202 — Medium Scanner/Scale

Some models are designed to fit with little or no modification into openings cut for previously installed scanners such as other Magellan[®] scanners, or NCR[®] scanner models 7820/24 and 7870. Other models are designed for applications with smaller footprint requirements.

Once the procedures in this section are complete, the scanner is ready for operation; with the exception that if a scanning-scale was installed, calibration will be required before placing the unit into operation. You must consult the local weights and measures authority to ensure that all legal requirements are met concerning calibration and certification. Section 5, *Calibration*, contains detailed procedures for calibrating the scale in either pounds or kilograms.

Figure 2-1. The 810x/820x Scanner and Scanner/Scale Family

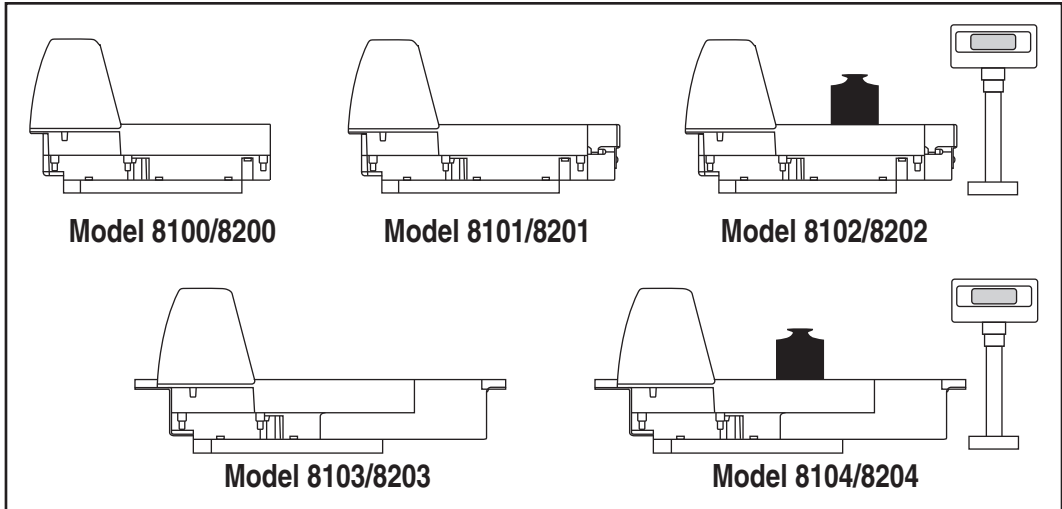

Pre-Installation Considerations

It should be noted that the scope of this manual does not encompass all factors related to worker safety and checkstand design. It does, however, offer a list of considerations that may be helpful in ensuring greater safety and productivity. Careful planning using these general guidelines should result in a more efficient, comfortable work environment.

The U.S. Bureau of Labor Statistics reports that the incidence of repetitive motion injuries has increased dramatically in recent years. Checkstand design and scanner installation and operation procedures can reduce the risk of repetitive motion injuries, but not eliminate it.

Although there are currently no formal guidelines for checkstand ergonomics, the Food Marketing Institute (FMI) and the National Institute of Occupational Safety (NIOSH) of the Department of Health and Human Services have released the reports listed at the end of these recommendations. These reports contain useful suggestions for ergonomic improvement of checkstand designs and scanner installation, maintenance and usage. Portions of the reports are summarized below. For copies of the complete reports, or to inquire about any modifications to the recommendations, contact FMI and NIOSH at the addresses listed at the end of these recommendations.

Checkstand Design

1. Select a design which allows load-sharing by several muscle groups (for example designs which allow the cashier to use both hands for scanning and bagging).
2. Select checkstands which deliver products to the cashier on an input belt and do not require the unloading of items from a cart. These designs put less stress on the cashiers' shoulders and back.
3. Minimize the distance between the input and take-away conveyors (i.e., the distance the cashier has to reach to move the products).
4. Minimize the width of the input conveyor to reduce the cashier's reach to items on the far side of the belt; use a diverter to direct products closer to the cashier.
5. Select a design which encourages the cashier to slide products across the scanner rather than gripping and lifting. Make sure the horizontal surface of the scanner is flush with all surrounding surfaces.
6. Choose a design which integrates the scanner and scale to eliminate extended reaches and lifts during weighing tasks.
7. Provide an easily accessible bag stand at a height 13 - 17 inches (33 - 43.2 cm) lower than the top surface of the checkstand to reduce stresses to the shoulders, elbows, and risks associated with lifting products into bags.
8. Do not position the bag stand between the cashier and the scanner, due to the increased reach involved.
9. Position the scanner's horizontal scanning surface 34 - 36 inches (86.4 - 91.4 cm) above the floor. Maintain a minimum of five inches (12.7 cm) clearance between elbows and work surfaces.
10. Provide adjustable keyboard mounting (height, tilt, and horizontal reach).
11. Position the printer, cash drawer, and other checkstand devices the cashier uses within easy reach (less than 18 inches/45.7 cm).
12. Provide adequate toe space, foot rests or rails, antifatigue mats, and where feasible, an adjustable seat or stand against which the cashiers can lean.

Scanner Installation

1. Mount the horizontal surface of the scanner flush with the countertop to encourage slide scanning rather than lifting.
2. Position the centerline of the scanner read area 8 - 10 inches (20.3 - 25.4 cm) from the edge of the checkstand (cashier side).

Scanner Maintenance

1. Keep scanner windows clean. This will improve productivity and reduce rescans.
2. Replace scanner glass when excessive scratches are evident.

Ergonomic References

Anonymous, 1992, "Ergonomic Improvement of Scanning Checkstand Designs",
Food Marketing Institute
800 Connecticut Ave. N.W.
Washington, D.C. 20006

Grant, Katharyn A. et al., 1992, "Ergonomic Evaluation of Checkstand Designs in the Retail Food Industry",
National Institute of Occupational Safety and Health
4676 Columbia Parkway
Cincinnati, Ohio 45226

Scanner Usage

1. Minimize handling of heavy/bulky products. Leave these items in the cart and use an alternative entry method such as key entry of short PLUs, or handheld scanning.
2. Regularly train cashiers in proper scanning methods and ergonomics principles, such as:
 - Develop a smooth fluid motion during scanning, sharing work equally between hands.
 - Use the entire hand for grasping and lifting items.

Since the scanner reads labels on all four sides plus the bottom, there is no need to turn a bar code toward either of the scanner windows.

Develop efficient scanning motions, not necessarily faster hand movements. Simply slide the item across the scanner's horizontal window with as little orientation motion as necessary.

Leave items in an upright position; do not lift and tilt.

Learn how the scanner functions and where the scanning area is located.

Do not favor either the vertical or horizontal window; slide items across the scanner in their natural orientations on the checkstand as much as possible.

Site Preparation Overview

Consider the following factors before installing the scanner/scanning-scale and its optional Remote Scale Display.

Ventilation Requirements. The scanner operates without the use of a ventilation fan. As long as there is adequate convective air flow and no major heat producing equipment in close proximity, the unit's housing provides adequate heat dissipation. The air temperature in the checkstand around the scanner must not exceed 104°F (40°C).

Service Access Requirements. Routine operations such as 'zeroing' and calibration do not require removal of the scanner from the checkstand or disassembly of the product. The installer should plan service access for the AC/DC Power Supply and cables.

Recommended Power Installation. Since the typical grocery environment includes conveyor belts and electric motors, care should be taken to ensure that the scanner has a supply of "clean" power (power without excessive electrical noise). A wiring diagram shows the recommended wiring that will provide the scanner with a "clean" source of power. Refer to Figure 2-4.

Counter Preparation. Since the majority of grocery checkout lanes are designed as “left-hand take away,” the counter drawings in this section focus on this counter design. Simply reverse the layout for a “right-hand take away” requirement. The unit scans equally well in either of these two configurations.

Liquid Drainage. Should a liquid spill occur, ensure that moisture can flow through the checkstand without pooling.

Leveling. Plan ahead and provide screws/bolts in the checkstand mounts and a leveling guide (board) to allow leveling of the scanner or scanning-scale within the counter. Use a 0.375” thick board to replicate the mounting flange on the long scanner or scanning-scale, and adjust screws or bolts until the board is flush within the counter. Use a 4.0” wide board stood on its end to adjust leveling screws/bolts in rail support applications.

Cable Routing. Placement of the scanning-scale should be planned to allow easy access to other components as well as optimize communication between the scanner, the POS terminal and the optional Remote Scale Display. Note that cables may drop straight down from the scanner’s connector panel, or may be conveniently routed along the unit’s side using the hardware provided. Do not route interface cables near any electrical motors or other sources of electromagnetic interference.

Remote Scale Display Placement. The customer, and checker in some instances, must be able to easily view and read the Remote Scale Display. Ambient light and mounting height considerations are discussed later in this section.

Vertical Clearance. Provision must be made to allow adequate space above the scanner bonnet for removal and replacement of the All Weighs™ Platter (the L-shaped platter). Optimal clearance permits the platter to be grasped at its top vertical edge and lifted for removal without obstruction (such as a fixed keyboard mount or any type of enclosure). Should such an enclosure be unavoidable, an alternate method of platter removal using two coins may be employed, however a minimum vertical clearance of 1.5” (3.8 cm) MUST be provided (reference Figure 2-2). Another consideration is that the scan zone must be kept free of obstructions such as enclosures, keyboard mounts, etc.

Figure 2-2. Vertical Clearance

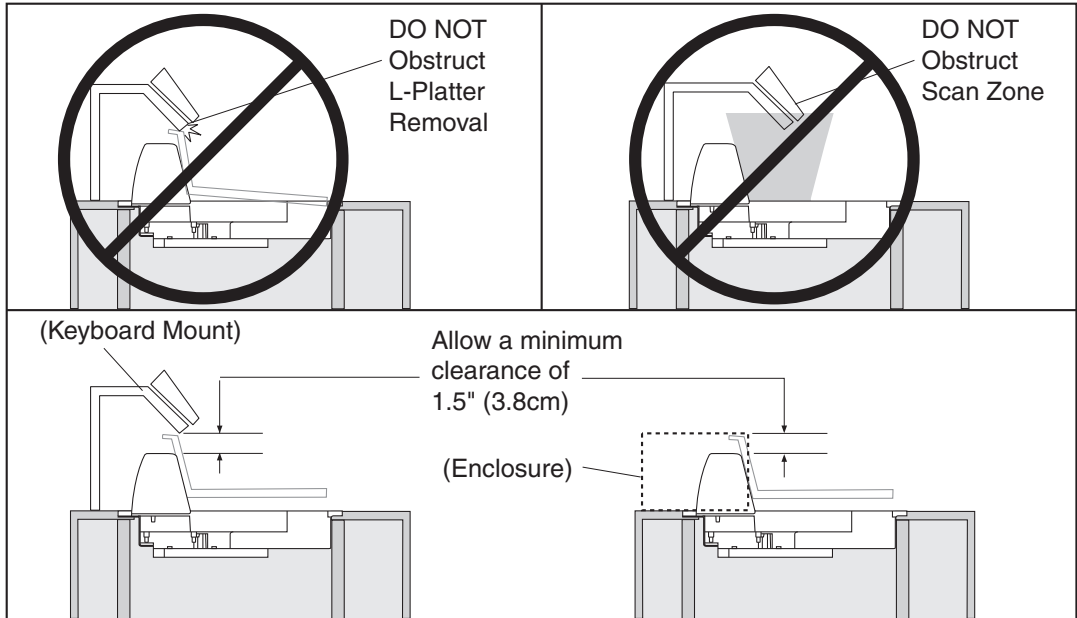

Ventilation and Spacing

The scanning-scale's perimeter housing has been designed to provide adequate space for convective cooling and unrestricted movement of the weighing apparatus. Figure 2-3 shows the debris chutes and ventilation slots. The checkstand design must allow:

- The ambient air temperature inside the checkstand adjacent to the scanner must not exceed 104°F (40°C).
- A source of air that provides adequate cooling by convective air flow.



NOTE

DO NOT place the scanner in a close-fitting, fully enclosed checkstand. Provide a **MINIMUM** of 16 square inches (103.2 square centimeters) of air intake from below the installation for sufficient convective cooling.

If motors, conveyor belts, or other heat producing equipment are located near the scanner, forced air ventilation may be required. In most installations, a 30 cfm (.84 cmm) axial fan should provide sufficient air movement. If a ventilation fan is installed, one with a removable filter that may be washed or replaced is recommended.

Figure 2-3. Debris Chutes & Ventilation Slots

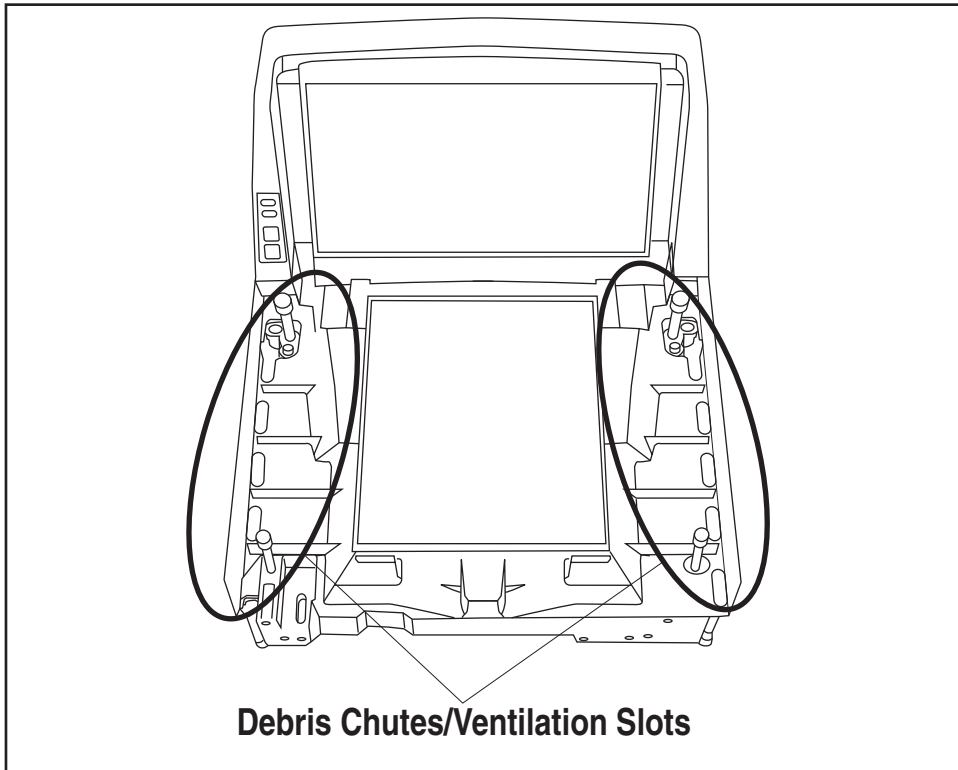

Service Access

The scanner and scanning-scale have been engineered to allow performance of all routine service and maintenance (such as “zeroing” and calibration) without removing the scanner from the checkstand. Additionally all cable connections made at the scanner can be connected and removed while the unit is sitting on the countertop. The installer should provide service access to all remaining cable connectors as well as the AC/DC Power Supply (if installed).

Power Installation

Reference the wiring diagram in Figure 2-4 for the recommended fusing arrangement.

Grounding

The AC/DC Power Supply should have an AC outlet with a clean earth ground. If you are not sure how to verify the amount of electrical noise (interference) on the power line, ask a qualified electrician to measure the input line voltage.

Figure 2-4. Input Power Wiring

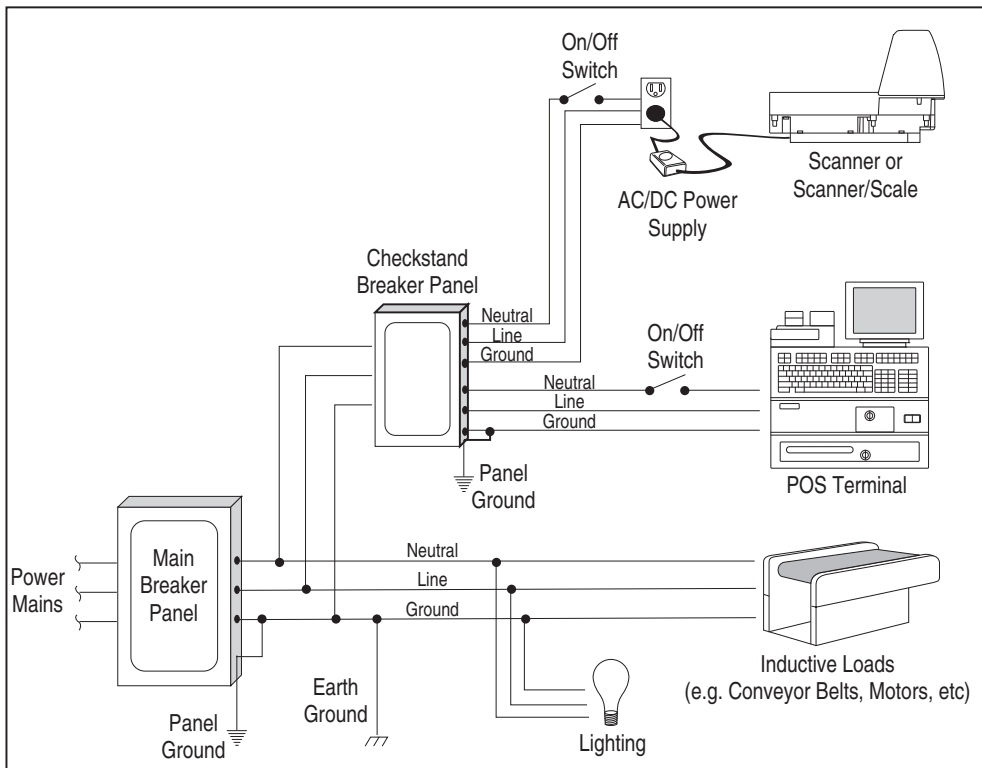

Checkstand Preparation

Reference Figure 2-5. When performing a first time installation into a new checkstand, verify before cutting that room will be allowed for cabling and the AC/DC Power Supply. When making the opening, take extra care to accurately cut to the correct dimensions. Mounting may require installation of support(s), countertop routing, or other such devices. Depending upon checkstand design, you may wish to install an item diverter to direct items toward the scan window. See the instructions in this manual titled “Counter Cutout” for more details concerning the location and preparation of the opening.

Figure 2-5. Installation Overview

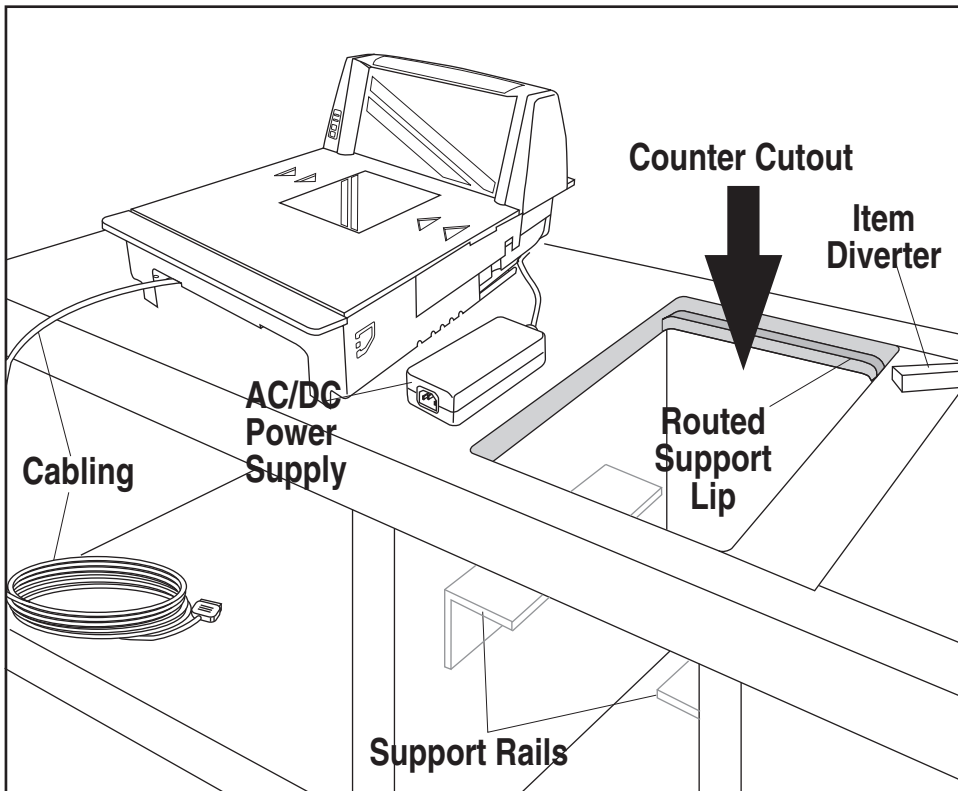

Liquid Spills and Moisture

Select a checkstand design which allows fluids to flow through, and directs liquids away from any electronic equipment or storage areas.

Counter Cutout

The most important consideration when planning the counter opening for the scanner is the operator's comfortable reaching distance. The ideal, ergonomically sound installation allows items to be directed within easy reach, and a scanning area requiring no lifting or special orientation of items. If you haven't already read the information at the beginning of this section titled, *Pre-Installation Considerations*, please do so before continuing these instructions.

The symmetrical design of the scanner permits the operator to easily pass items from one hand to the other while scanning (either from right-to-left or left-to-right). With the unique 360- scan zone, scanning is accomplished in one fluid motion. The operator simply slides the item from the conveyor belt or diverter area through the scanning area and passes the item to the other hand, which in turn bags it or places it on a take-away conveyor belt. Movement should flow naturally over the surface of the scanner.

Note that the following guidelines for preparing an existing checkstand to accept a scanner, or incorporating the unit into a new checkstand design will not be accurate for all installations. Although these guidelines will suffice for most standard installations, the installer may need to make adjustments for varying counter heights and thicknesses, support design, or other checkstand limitations.

Figure 2-6 shows a typical "left-hand-take-away" checkstand design.

Follow these basic steps to install the unit:

1. Select a position for the scanner that offers a smooth product flow which best accommodates the reaching distance of the average operator.
2. Cut the opening in the countertop. Select the appropriate drawing from Figure 2-7, Figure 2-8, or Figure 2-9 for your model.
3. Install the AC/DC Power Supply, the Remote Scale Display cable and the interface cable(s) observing the following:

Interface cables (and display cable, if applicable) should be routed away from all highly inductive electrical devices, like motors and conveyor belts, and even away from the unit's power cable if possible.

Cables should be easy to remove in the event that replacement is required. A little planning now will save a lot of frustration later.

4. Connect and verify all system operations.

The scanner should be installed so that leading and trailing edges of the All Weighs™ Platter are flush with the countertop to enhance smooth, slide-through scanning (reference the insert in Figure 2-6). Keep in mind that the debris chutes on both sides of the platter provide the necessary clearance for proper scale operation if you are installing a scanning-scale (you won't need to provide an additional gap for that).

Figure 2-6. Typical Checkstand Design & Cutout Location

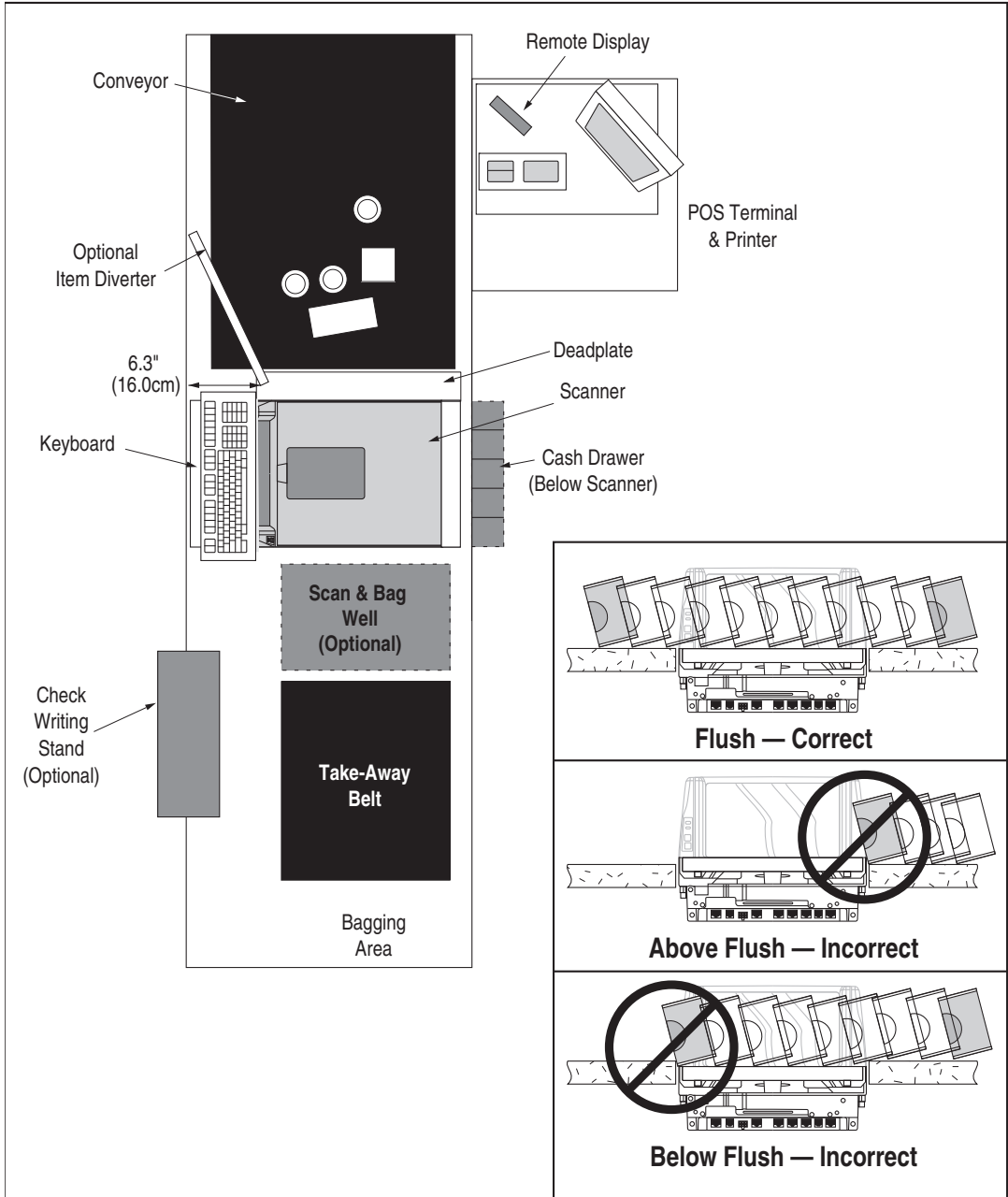

Refer to the appropriate drawing (Figure 2-7, Figure 2-8, or Figure 2-9) for dimensional information concerning the model you'll be installing.

Figure 2-7. Model 8100/8200 (Short Scanner) Cutout Dimensions

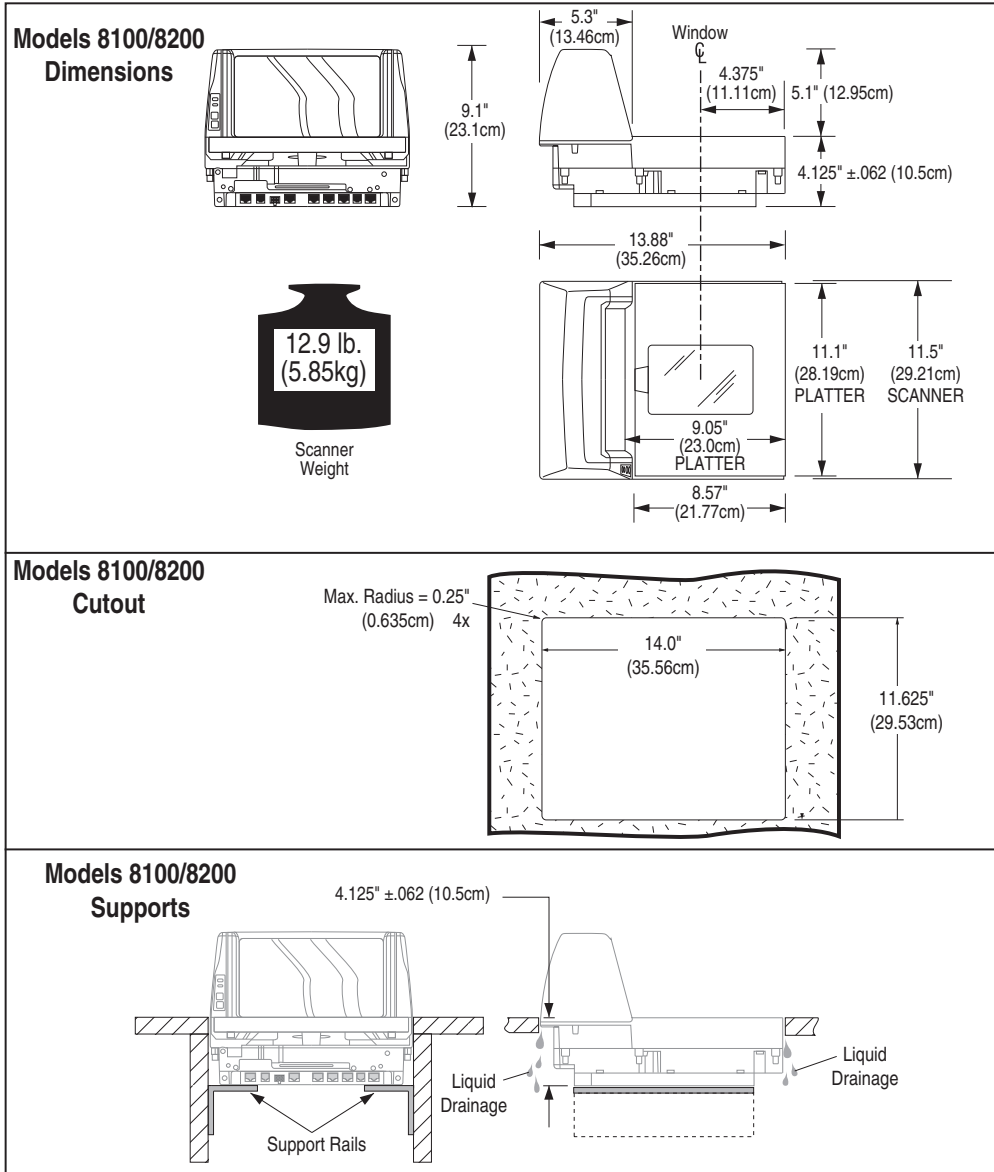

Figure 2-8. Model 8101, 8201, 8102 and 8202 (Medium Scanner or Scanner/Scale) Cutout Dimensions

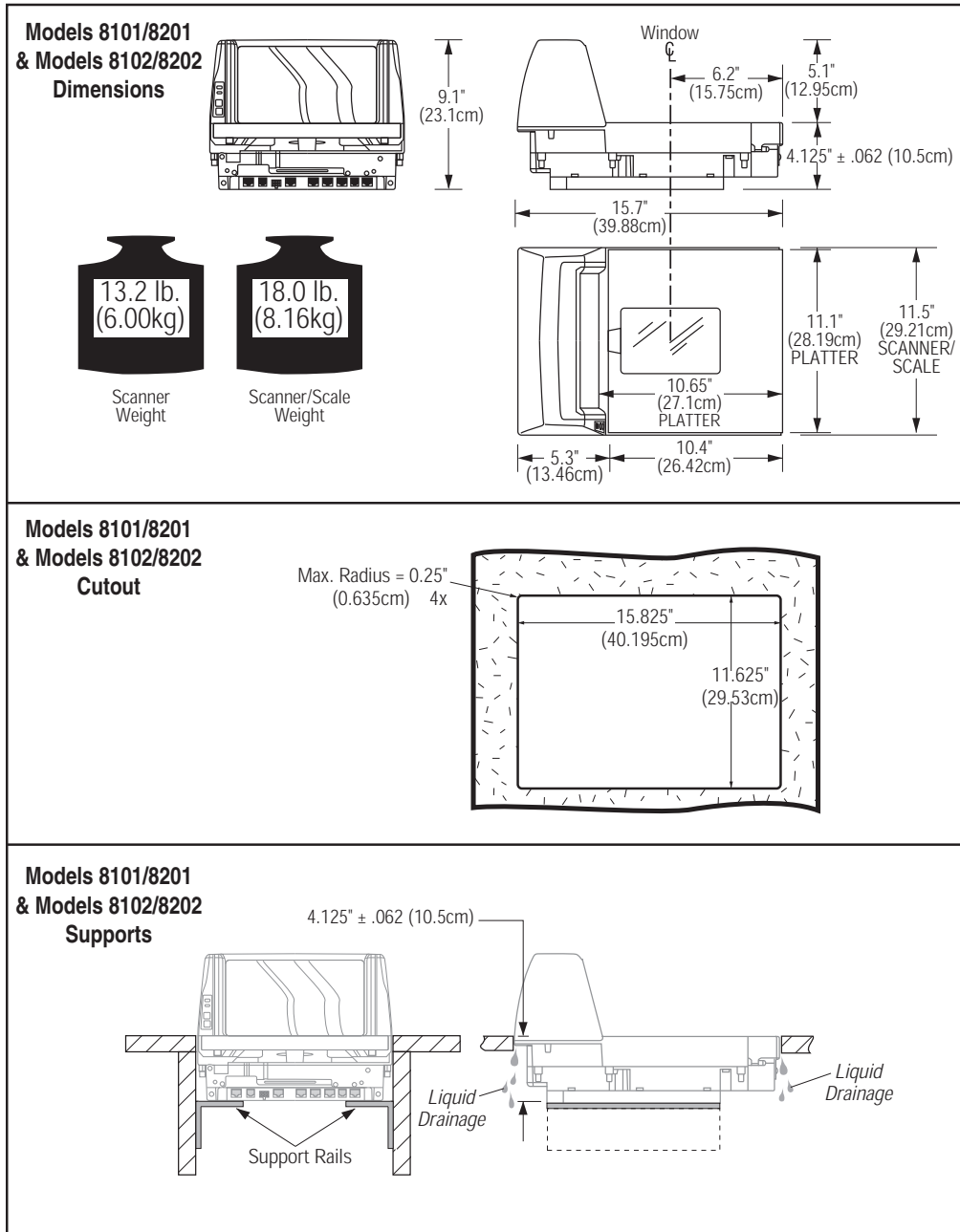
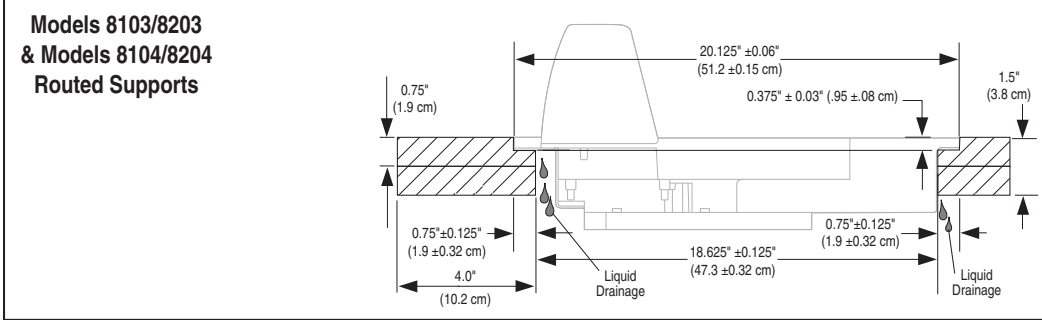
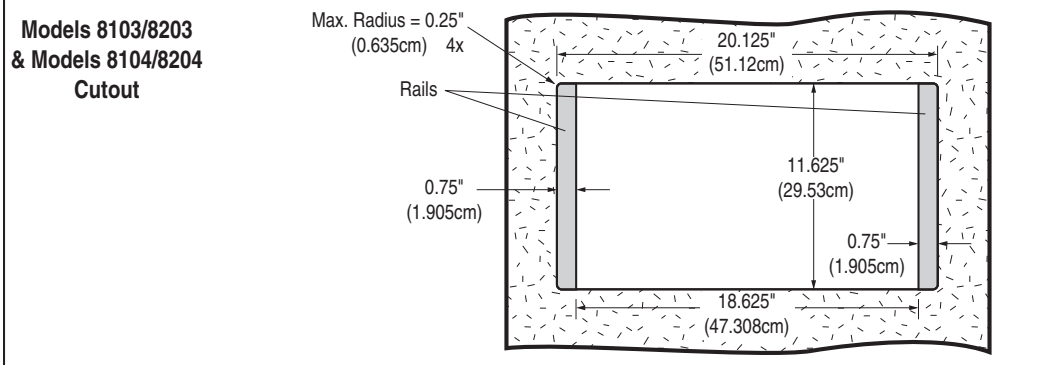
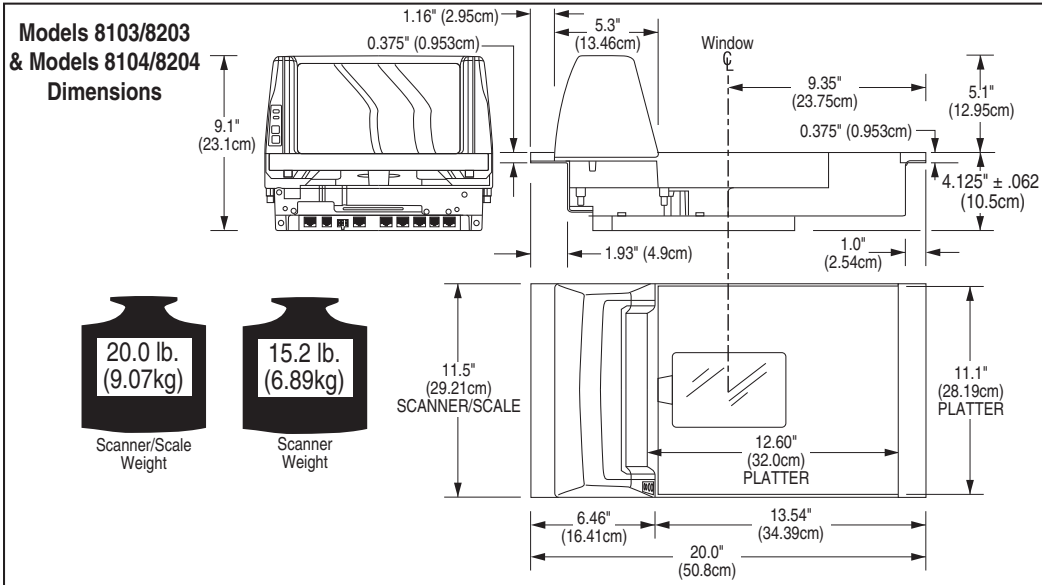

Figure 2-9. Models 8103, 8203, 8104 and 8204 Long Scanner or Scanner/Scale Cutout Dimensions



Checkstand Mounting

There are a number of things to take into account when installing the unit into a checkstand. Key factors are ergonomic/worker safety, loading capacity and stability. Consider the scanner or scanning-scale's weight when calculating the robustness of construction needed to support it as well as maximum capacity of weighed and scanned items.



NOTE

If you choose to rout a countertop with a thickness of 0.75" (1.9 cm) plywood, you'll need to add a backing strip that supports the area routed out for the support flanges (see Figure 2-5). This support strip should minimally be made of 0.75" (1.9 cm) thick plywood and be approximately 4.0" (10.2 cm) wide and 14.0" (35.6 cm) long. This strip should be glued as well as screwed to the underside of the countertop.

Installation Overview

The preceding *Site Preparation Overview* dealt with installed location and counter preparations to accommodate the scanner or scanning-scale. Having completed those steps, physical installation of the scanner or scanning-scale can begin. The following instructions apply to all models.

This section describes:

1. Unpacking the unit.
2. Verifying operation before connecting to a POS system.
3. Routing and connecting cables.
4. Validating that your scanner communication parameters match the POS terminal's system requirements.
5. Functional testing to verify operation when connected to the POS system.

The following text describes each of these steps.

Unpacking

To unpack the unit:

- Inspect the package for signs of damage that may have occurred during shipping. If damage is found, report it to your carrier immediately.

- Lift out the accessory box containing the AC/DC Power Supply, optional Remote Scale Display and cable (if present), and the Quick Reference Guide.
- Remove the Quick Reference Guide and familiarize yourself with the unit's controls and features. Leave the guide at the checkstand when the installation is complete.
- Remove the protective packing and carefully lift the unit from the carton. Be sure to save the box and all packing material. In the event of failure, the unit must be returned to the factory in its original packaging.
- Carefully lift off the All Weights™ Platter as shown in Figure 2-19 and remove the protective foam pieces securing the weigh mechanism. Set the platter back in place.



NOTE

For added protection during shipment, the All Weights™ Platter is covered with a tight-fitting layer of vinyl as shown in Figure 2-10. This vinyl layer **MUST BE REMOVED** before placing the unit into service.

Figure 2-10. Remove Protective Vinyl

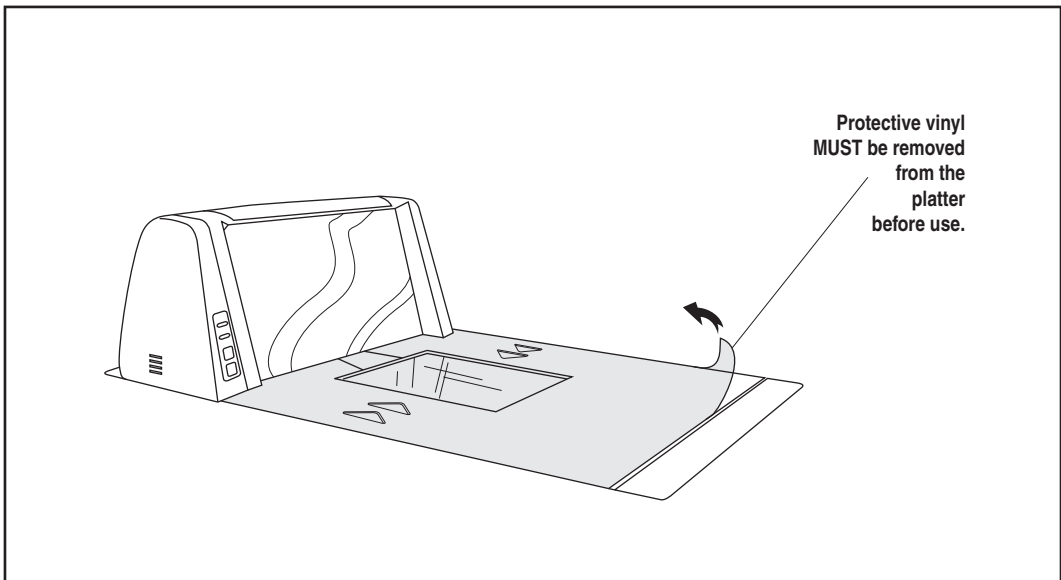

- Proceed to the *Operational Verification* instructions below.

Operational Verification

Follow these steps to ensure that your unit has arrived undamaged and is fully functional before installing it in the counter and connecting it to your POS system.

1. If the unit is a scanning-scale, connect the Remote Scale Display to the proper connector on the unit's connector panel (refer to Figure 2-17). Note that if the Remote Scale Display is not connected, a scanner power-up Selftest will sound a long, low beep, and the number "8" will appear on the 7-segment display indicating a remote display error. Power-down, connect a known-good Remote Display to the appropriate port, and restart to correct this problem. Alternatively, you can disable the Remote Display using programming bar codes (see Section 6, *Programming* for more information).
2. Connect the power cable at the scanner then at the AC outlet.

When power is applied to the unit, the normal indicator sequence is:

- The green light will be lit (dim) steadily.
- If the Selftest detects a problem, the 7-segment display will display a number code. Refer to Section 4, *Problem Isolation*, for a description of failure codes and problem isolation procedures.



NOTE

Scale calibration may be necessary to obtain a zero reading on the display on rare occasions.

3. The unit should be permitted to reach thermal equilibrium before proceeding to the next steps. (Reference the topic *Warm-Up Time* in Section 1.) When the unit is moved from a cooler temperature (such as a storage area) to a warmer environment (such as a checkstand location), a period of 60 minutes must be allowed to acclimate the unit to ambient conditions. Once installed and powered up, a "power-up" warm-up period of 15 minutes must be allowed before calibrating or performing weighing operations. These two warm-up periods may run concurrently.

4. Verify that the scanner or scanning-scale passes an operational test by observing the following:

Scanner. Pass UPC/EAN bar code labels in front of the scanner's windows. Since the interface cable is not yet connected to the POS terminal, the scanner may be limited to reading only one or two labels (see the note that follows). The scanner indicates when each label has been successfully read by flashing the green scanner light and emitting a good read tone (beep).



NOTE

When not connected to the host, the scanner may be limited to reading only one or two labels. (This limitation is dependent upon the interface type.) To scan multiple labels without connecting to the host, place the unit in Scanner Diagnostic Mode by pressing the Volume/Tone Push Button for four seconds.

Scale. If the Zero lamp is not lit, press the Scale Zero Push Button momentarily. If the scale is operating correctly, the yellow LED will illuminate and remain on steady, and the display will show a reading of 0.00 lb (0.000 kg for metric). If the display is blank or a is displayed, it may be necessary to calibrate the scale before continuing. Refer to Section 5, *Calibration*, for calibration procedures.

Remote Scale Display. Check to verify that 0.00 lb (0.000 kg for metric) is displayed, then place an item on the weighing platter. Verify that the display shows a weight and that the yellow LED goes out. Remove the item and observe that Remote Scale Display shows 0.00 lb (0.000 kg for metric) and that the yellow LED is On.

5. Unplug the AC power cord from the outlet and disconnect the power cord and Remote Scale Display cable from the scanner's connector panel.

After you have verified that the scanner and scale (if present) are completely functional, continue with the following procedures to complete the installation.

Diagnostic Modes

Two diagnostic modes are available which allow you to initiate scanner or scale diagnostic tests, as well as verify the scanner's ability to read bar codes.

Scanner Diagnostic Mode

While in Scanner Diagnostic Mode, continuous scanning of labels is allowed, permitting the user to scan an unlimited number of bar codes while troubleshooting problems. Under normal operation, the scanner stores label data, awaiting the signal which transmits it to the host. When the scanner is not connected to a host, it may read and store only up to two labels, then quit reading until power is cycled (clearing the memory). Scanner Diagnostic Mode removes this limitation.

To place the scanner in Scanner Diagnostic Mode, press the Volume/Tone Push Button for approximately four seconds. While pressing the button, the scanner will first sound three tones, wait a few seconds, then sound six rapid tones; after which you should immediately release the button.

While in Scanner Diagnostic Mode, identification numbers for interface¹ type, firmware and configuration will scroll continually across the scanner's 7-segment FRU (Field Replaceable Unit) display. This is useful information for field diagnostics. See Figure 4-1 for the location of the display. For example, if the dual cable RS-232 interface (type 05) were enabled, the firmware designation was R96-1234, and the configuration was R96-5593, the following would be shown (slowly, with blanking between each of the items):

IF-05 r96-1234 r96-5593.

To exit Scanner Diagnostic Mode, cycle power to the unit or press and hold the Volume/Tone Push Button for eight seconds to reset the scanner. See the topic, *Scanner and Scale Reset* in Section 3 for more information about unit resets.

1. A listing of scanner interface identification numbers is available in Section 6, under the topic, *Interface Type*.

Scale Diagnostic Mode

To enter Scale Diagnostic Mode, press the Scale Zero Push Button for approximately four seconds. Six rapid tones will be sounded, indicating the unit is leaving normal operation and entering Scale Diagnostic Mode. The Remote Display will flash a '1' across the display while the diagnostic routine is being run. When diagnostics are completed successfully, the display will indicate...

- that the unit has passed the diagnostic test by displaying **PASS**.
- a visual verification of display function in that all segments will be displayed in the form of: **-18.8.88**.
- the number of times the scale has been zeroed (represented by x), as in **Zero XXXX**.
- a listing of how many times the unit has been calibrated and zeroed in the form of: **c XXX** where x equals the number of times the scale has been calibrated.

If the diagnostics routine is not completed successfully, the scanner will sound a series of tones and the Remote Display will show an error code. Turn to Section 4, *Problem Isolation* for a description of error codes.

Press the Scale Zero Push Button once more to reset the unit and exit Scale Diagnostic Mode. See the topic, *Scanner and Scale Reset* in Section 3 for more information about unit resets.

Cables & Connections

Considerations when routing the power and interface cables for the scanner and scanning-scale are:

- Ensure that cables are not pinched, kinked or pierced.
- Do not route interface cables in close proximity to electrical motors or other sources of electromagnetic interference.
- Cables can drop directly from their connectors on the scanner, or, alternatively, can be routed along the scanner's side to the back (see Figure 2-11).

Do not plug the AC power cord into the outlet at this time. It is a good practice to always connect the power cable to the scanner first before plugging it into the AC receptacle. The procedures titled, Set-Up, provided later in this section will instruct you to connect the power cord at that time. Figure 2-11 illustrates the basic cable routing scheme.

Figure 2-11. Cable Routing

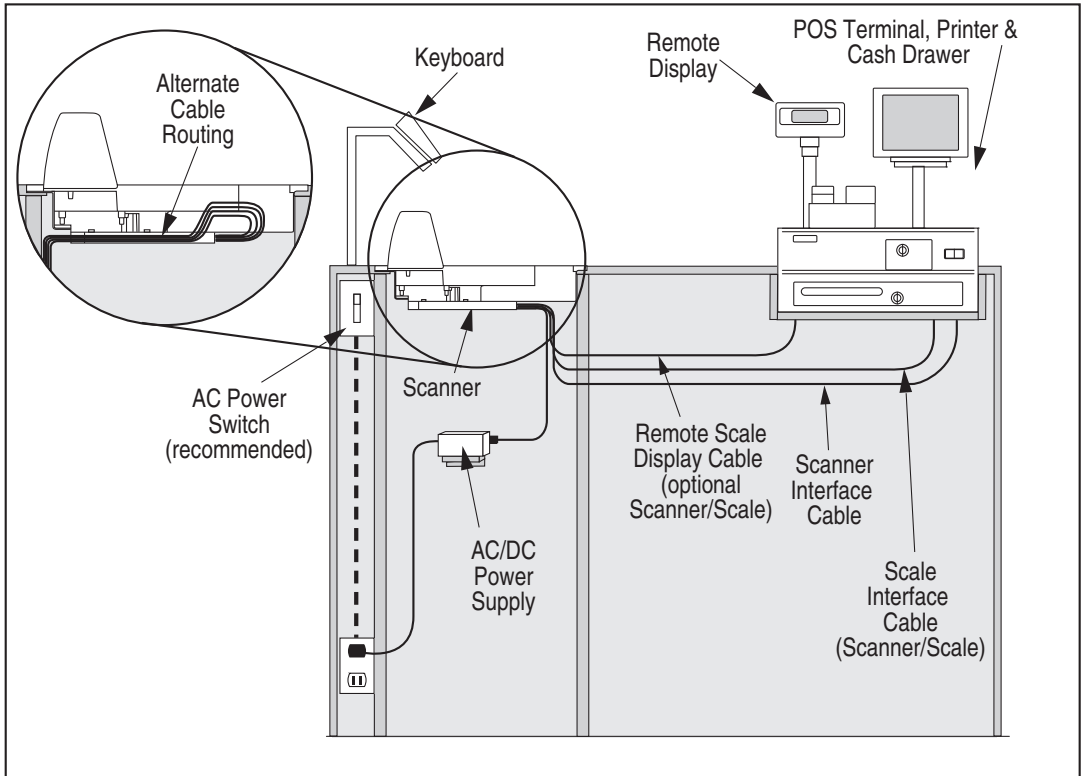
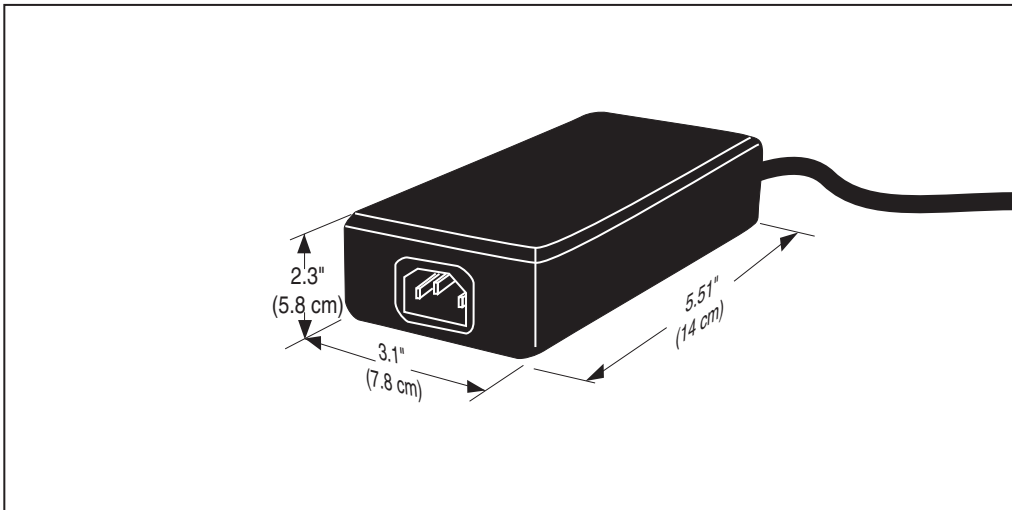

Figure 2-12 provides physical dimensions for the AC/DC Adapter (part number 8-0582).

Figure 2-12. Maximum Physical Measurements: AC/DC Adapter



Remote Scale Display Placement/Installation

When installing the optional Remote Scale Display, consider both the customer's viewing angle and the amount of daily ambient light conditions anticipated at this installation site. Figure 2-13 shows available adjustment for the display head.

Lighting Considerations

The display will be easily readable unless placed in direct sunlight or other very strong light sources. Light interference will not be a factor in most installations.

Viewing Angle

The optimum viewing angle is directly facing the customer. To ensure that the display is easily readable for the majority of your customers, the display should be approximately 48 to 60" (122 to 152 cm) from the floor.



NOTE

Check with local Weights and Measures authorities regarding proper positioning of scale displays used in retail trade.

Figure 2-13. Remote Scale Display

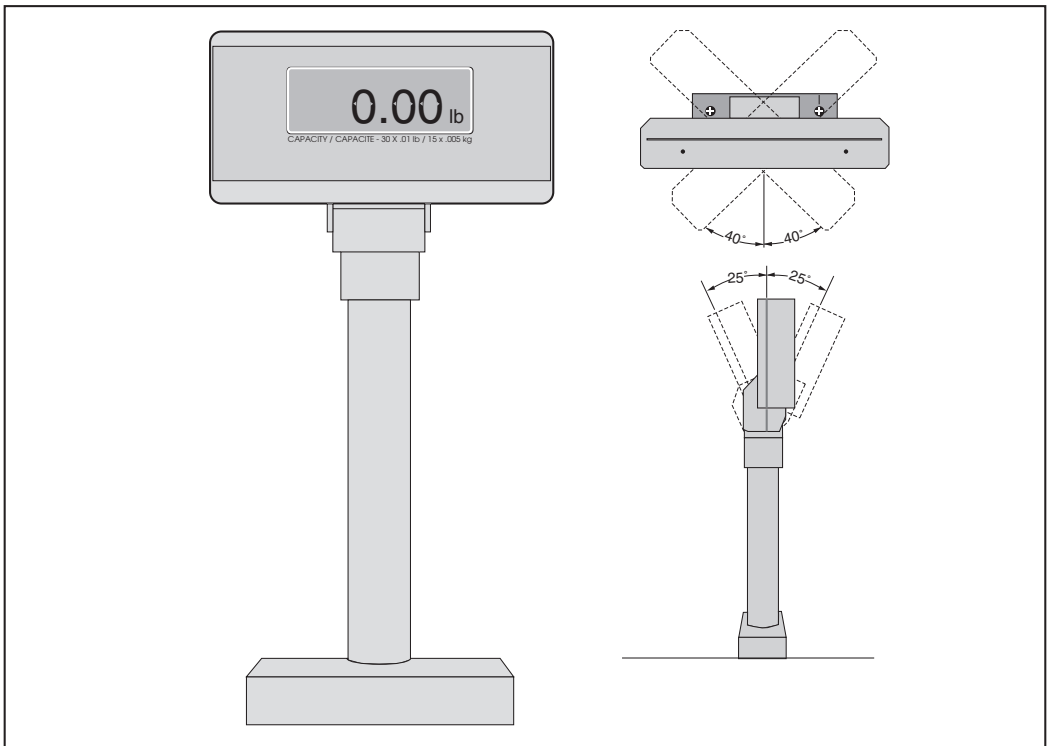



NOTE

The connector at the Remote Scale Display end is secured with a rubber band during shipping to prevent damage to the “locking tabs” (see Figure 2-15). After routing the cable, remove this rubber band before the cable end connecting to the Remote Scale Display head. Failure to remove the band will keep the connector from latching properly when it is connected to Remote Scale Display port.

Placing and Installing the Remote Scale Display

(Short Pedestal Base ONLY)

1. Determine where you want to install the Remote Scale Display based on your counter design, the viewing angle and lighting considerations discussed previously. Reference Figure 2-14 for the display’s physical dimensions.
2. Use the short pedestal base template provided in Figure 2-16 to mark locations of the mounting screw and cable routing holes. The mounting screw holes are on 3 3/8” (8.57 cm) centers.



NOTE

Before drilling, ensure the holes in your base match with the holes indicated on the template.

3. The cable can either be routed through a 3/4” (19 mm) diameter hole directly under the mounting base or through the cutout in the back of the base (see Figure 2-15).
4. Drill the mounting screw holes using a drill bit of the appropriate diameter for your mounting screws or bolts.
5. Drill the cable routing hole using a 3/4” (19 mm) drill bit (optional).

It may be necessary to shorten the stalk that supports the display head so that the display is installed at eye level.

Figure 2-14. Physical Measurements: Remote Display (Short Base)

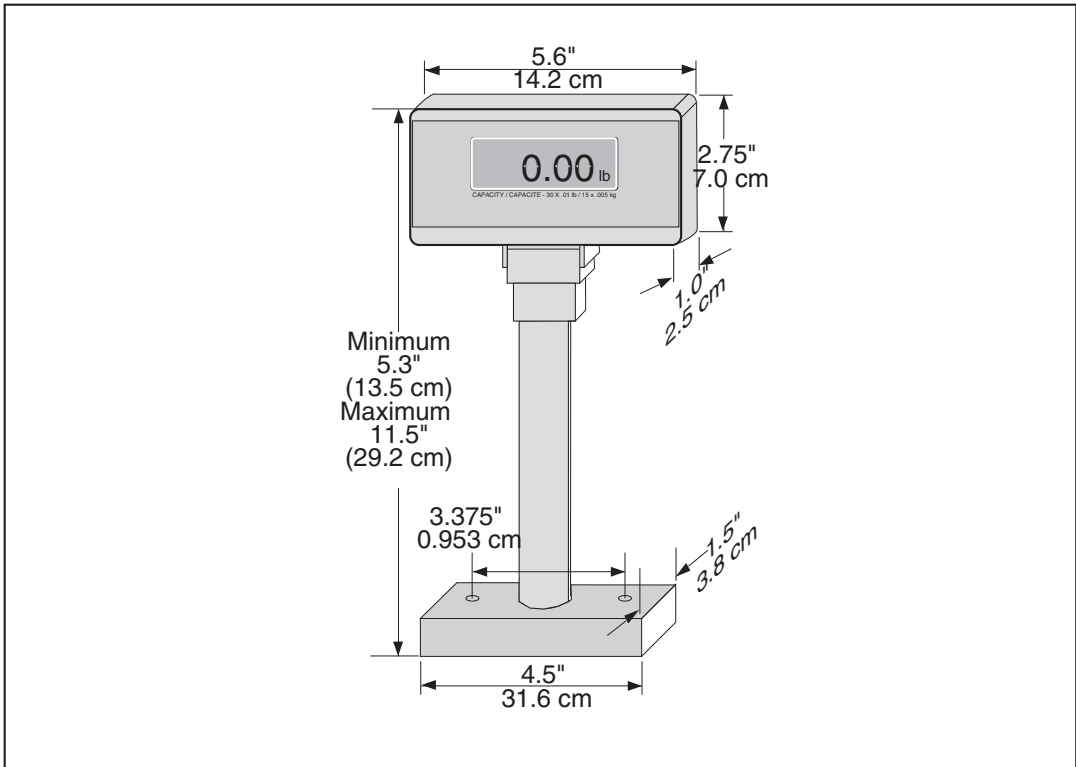

6. Cut the stalk to fit your installation (if required).
7. Route the cable through the base/stalk so that you can plug the connector into the display head.
8. Remove the rubber band from the connector and attach the connector to the display head.
9. Slip the display head onto the stalk/base.
10. Feed the entire remaining length of the Remote Scale Display interface cable through the cable routing hole so that the assembled Remote Scale Display can be positioned over the mounting screw holes.
11. Install mounting screws or bolts to complete the installation of the Remote Scale Display. Take care not to pinch or pierce the interface cable while securing the Remote Scale Display to the checkstand.

Figure 2-15. Remote Scale Display Components.

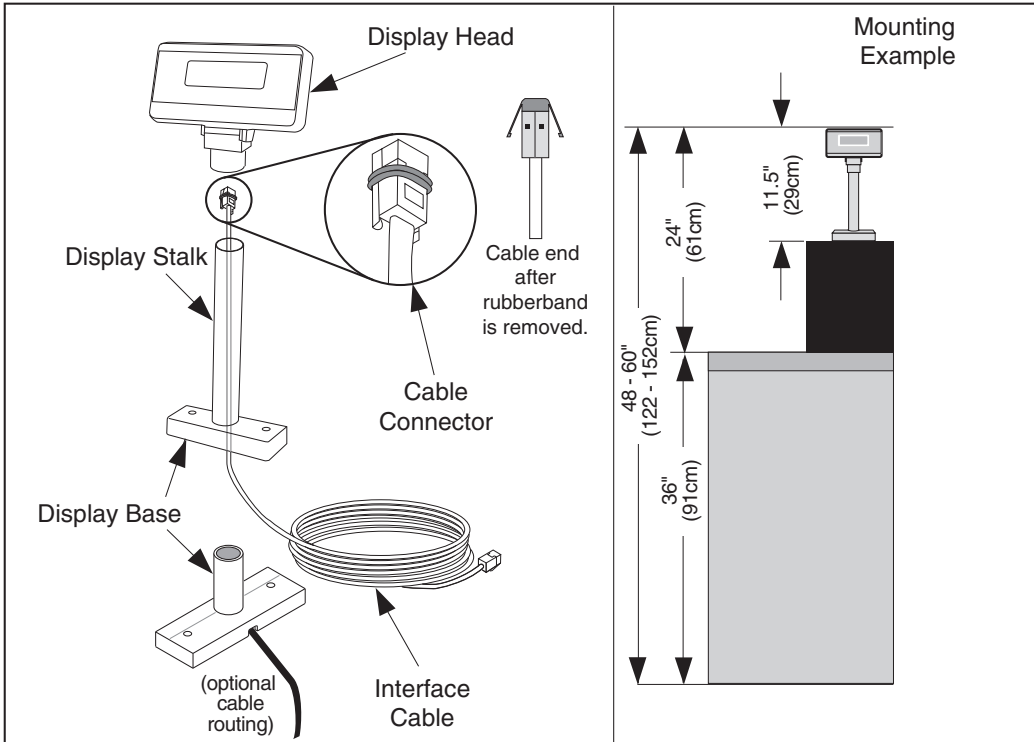
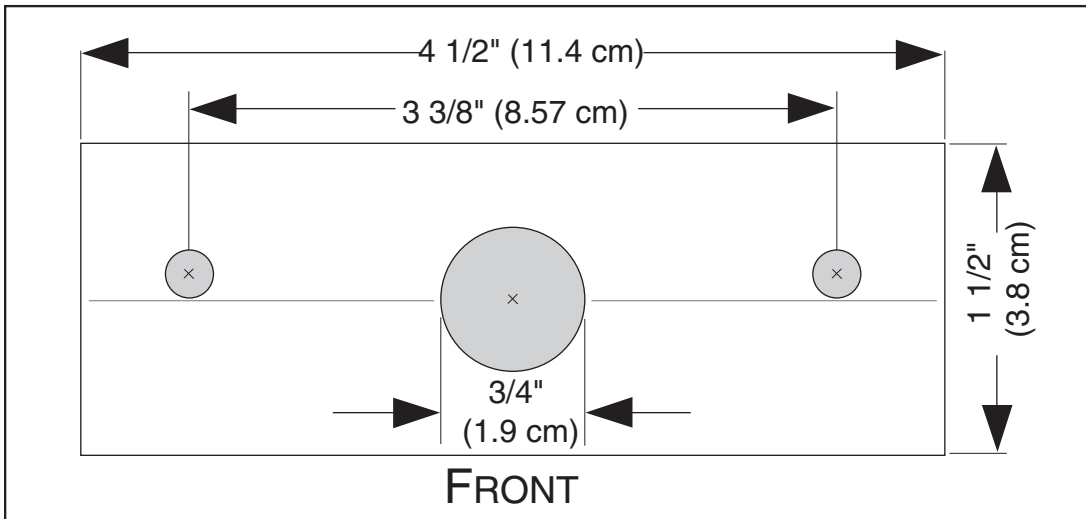

Figure 2-16. Remote Scale Short Base Display Mounting Template



Changing Weighing Modes

Your scanning-scale has been programmed for weighing in either pounds or kilograms depending upon the initial operating environment that was specified when you ordered your scanning-scale. If you need to change from pounds to kilograms or vice-versa, call technical support.

You can verify that the scale is set correctly for your country's requirements by observing that the Remote Scale Display shows the appropriate measurement symbol (lb or kg) when the power-up Selftest is completed.

LEGAL NOTE

Any time the scale weighing mode is changed, the scale must be re-calibrated before commercial use.

Set-Up & Installation

These setup and installation procedures assume that you have already prepared your checkstand to receive the scanner or scanning-scale. If you have not already made the counter cutout and routed power and interface cables, do so now as described in the previous instructions. If your checkstand has been prepared, proceed as follows:

Set-up

1. Place the unit on the checkstand next to the counter cutout.
2. Route the cables up through the cutout and connect the scanner and scale interface cable(s), and Remote Scale Display cable (optional) to the scanner. Some POS terminals require two interface cables; one for the scanner interface and one for the scale interface. Refer to Figure 2-17 for cable connection locations.

If you have a scanner with no scale, there will be only one interface cable to the POS terminal.

3. Connect the power cord to the scanner and route the other end down through the checkstand to the AC power outlet. **DO NOT** plug the power cord in at this time.

4. OPTIONAL — Route your EAS antenna cable down through the checkstand cutout. (Reference your EAS controller's set-up instructions for proper EAS antenna installation.)

Figure 2-17. Connecting Cables to the Scanner/Scale

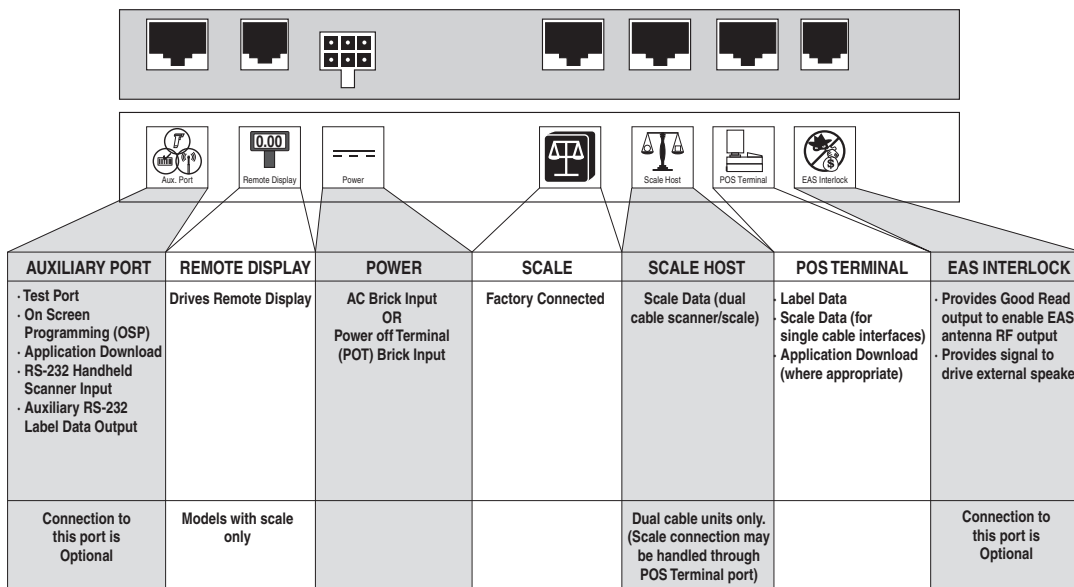
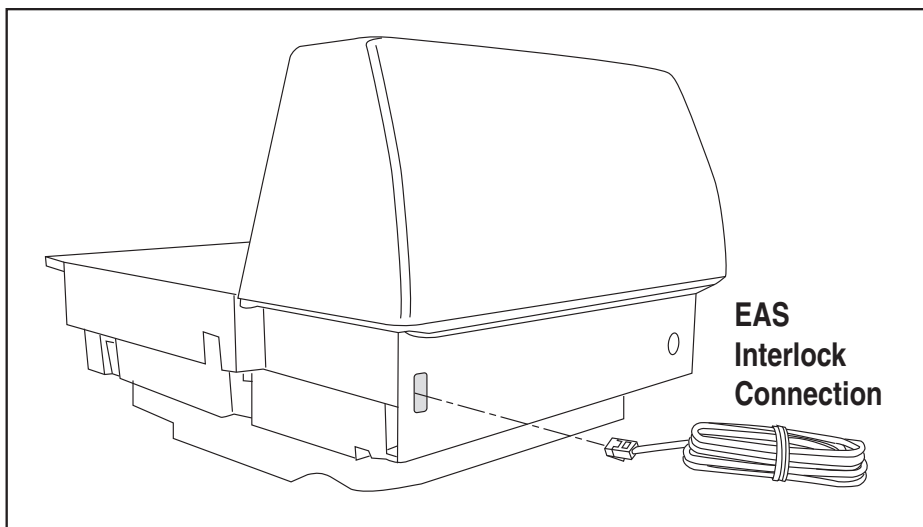

Figure 2-18. Connecting the Optional EAS Interlock Cable



Installation

1. Make sure that all cables are firmly attached (except that the AC/DC power supply should not be connected to the AC outlet yet).
2. Remove the All-Weights™ platter to gain access to the lift handles. Simply grasp the top edge of the platter, tilt slightly and lift off vertically (see Figure 2-19a). If the top edge is blocked, insert a coin into one or both indentations along either side of the platter and pry gently to lift the platter edge. Grasp the raised sides and carefully lift the platter off as shown in Figure 2-19b.

Figure 2-19. Removing the All Weights™ Platter

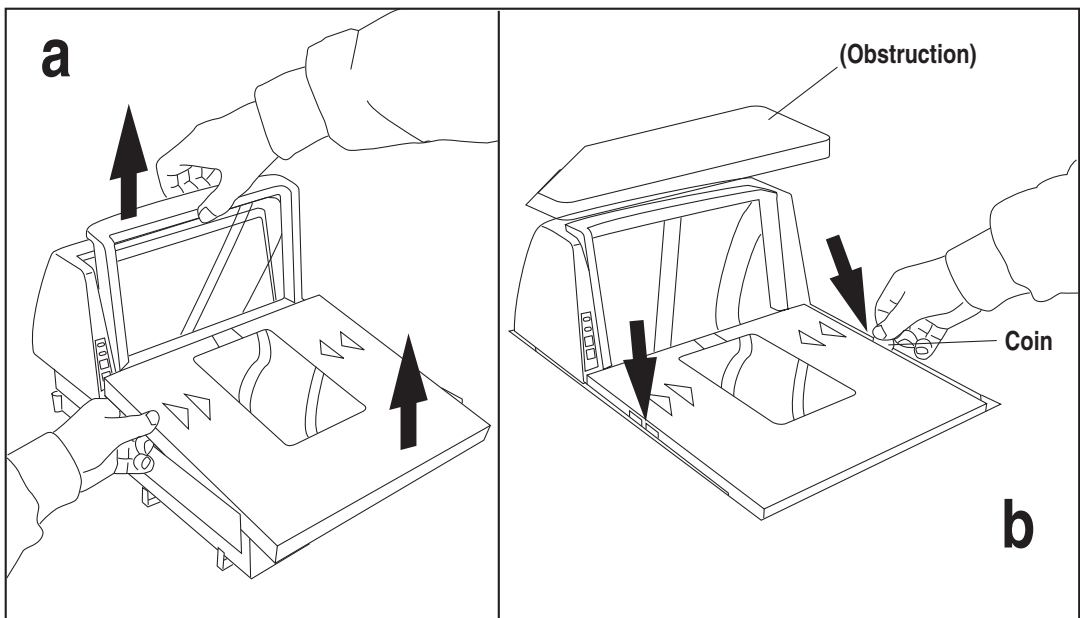

3. Rotate the lift handles to the vertical position and pick the unit up using fingers hooked into both handles. Tip: To keep the unit level during installation, spread the remaining fingers to steady the unit as shown in Figure 2-20b. DO NOT attempt to lift the unit using the plastic edges, scale frame, or any features other than the lift handles.
4. Lower the unit into the counter opening, ensuring that none of the cables are pinched, pierced or crimped.

5. Re-install the All Weighs™ Platter and verify that it is flush or just below flush with the countertop. This is necessary to provide smooth scanning from either direction. Make adjustments as needed to align the platter with the counter by moving support rails up or down, or consider installing screws in positions that will allow their use in adjusting the unit's position.



NOTE

Failure to install a scanning-scale in a stable and level position will inhibit weighing, calibration and zeroing operations. The platter MUST make unobstructed contact with all of its supports for proper weighing operation.

6. Once installation is complete, proceed with the *Operational Verification* procedures on page 19.

Figure 2-20. Using the Lift Handles

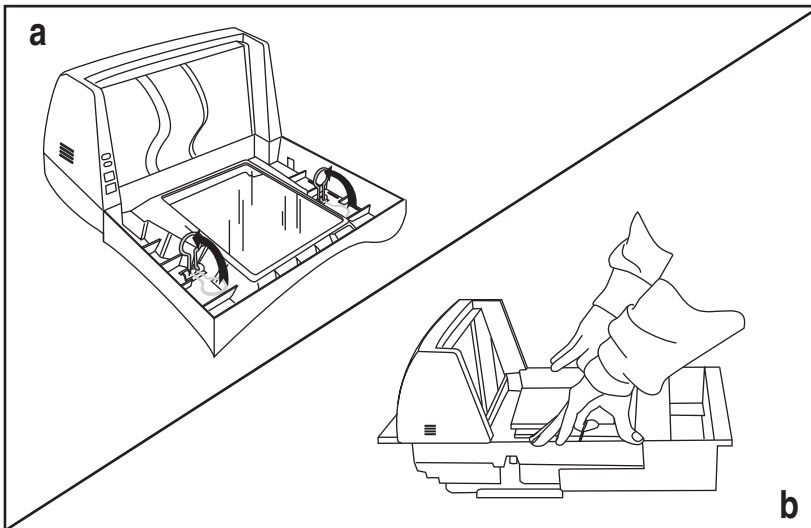

System Power-Up Recap

The System Power-Up procedure may vary depending upon the requirements of your POS system. It is generally a good practice to power-down (switch off) all equipment prior to connecting cables. Check with your System Supervisor and/or refer to your POS terminal manual for proper power-down and power-up procedures and interface requirements when connecting any peripheral device.

If you have not identified any specific requirements for your POS system, follow these steps.

1. Power-down the POS terminal.
2. Ensure that power is disconnected from the scanner.
3. Connect the scanner and scale interface cables to your POS terminal. This connection may use one or two cables depending upon your POS terminal interface.
4. Connect the Remote Display cable if your model is a scanning-scale and make any connections to optional equipment, such as EAS or a handheld scanner.
5. Power-up the scanner or scanning-scale by connecting the power cord to an AC power outlet. Wait for the unit to complete the Selftest routine (10 seconds maximum).
6. Power-up the POS terminal.
7. Verify that both scanning and weighing data are properly communicated between the scanner and your POS system. (Weigh and scan a few items.) If problems are encountered, refer to Section 4, *Problem Isolation*.
8. You have now completed installation and system integration of the scanner or scanning-scale. At this point, the scale must be calibrated and certified in accordance with the requirements of your state and/or local requirements. Refer to Section 5, *Calibration*, for calibration procedures.

NOTES

Section 3

Operation and Maintenance

The information contained in this section describes how to operate and maintain the scanner and scale. Topics include “how to’s” on scanning, weighing, re-zeroing the scale, removing the top cover and cleaning the upper and lower windows.

Scanning Items

To scan items using the scanner, slide or push them through the scan zone as shown on this page. The scanner will work equally well with either a left-to-right or right-to-left motion through the scan zone. There is rarely a need to reorient an item’s bar code since the scanner can “see” the left, right, front and back side, as well as the bottom of an item.



NOTE

“Limited Scanning Mode” is entered by default by interfaces such as USB and IBM until a Point Of Sale (POS) terminal enables scanning. Labels are “chirped” while in this mode.

Figure 3-1. Scan Zone

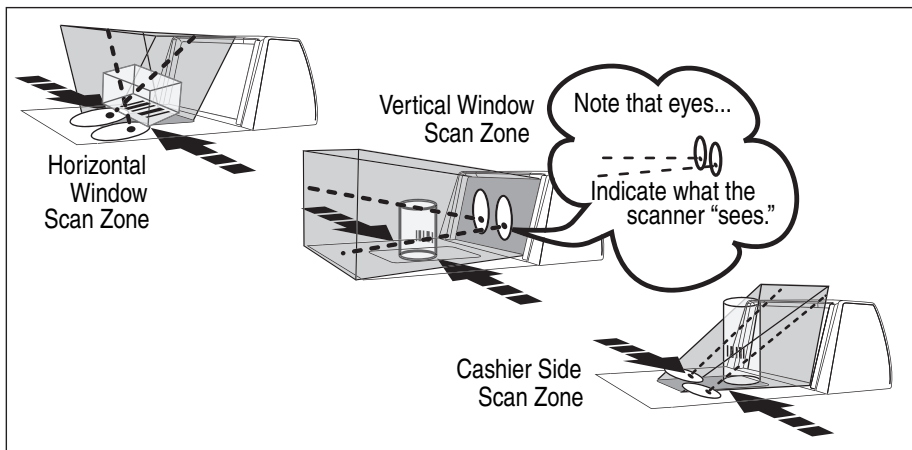

Proper Scanning Technique

The scanner was designed to provide the ultimate in ergonomic enhancements for Point-Of-Sale (POS) scanning. To take advantage of these advancements:

Practice the techniques below to improve scanning efficiency:

- Move the product across the horizontal window (See Figure 3-1).
- Since the scanner reads labels on all four sides plus the bottom, don't favor either the horizontal or vertical scan windows. Keep items in their natural orientation.
- Remember to slide or push items rather than picking them up. By avoiding any gripping, twisting and rotation of your hands and wrists, you can prevent repetitive motion injuries. This technique also relieves you from lifting possibly thousands of pounds per day.
- Develop a smooth fluid motion during scanning, sharing work equally between hands.
- Use the entire hand for grasping and sliding items.
- Develop efficient scanning motions, not necessarily faster hand movements.
- Learn typical locations for bar codes on packages; avoid "flipping" or rotating the items during scanning.
- Learn how the scanner functions and where the scanning area is located.
- Avoid covering any portion of the bar code with your hand.

Proper Weighing Technique

1. The L-shaped All-Weighs™ platter allows you to place items anywhere on its surface, including leaning against its vertical section, to be weighed accurately. (Reference Figure 3-2.)



NOTE

It is important that items rest entirely on the platter for their full weight to be accurately recorded.

Figure 3-2. L-Shaped Platter & Item Placement

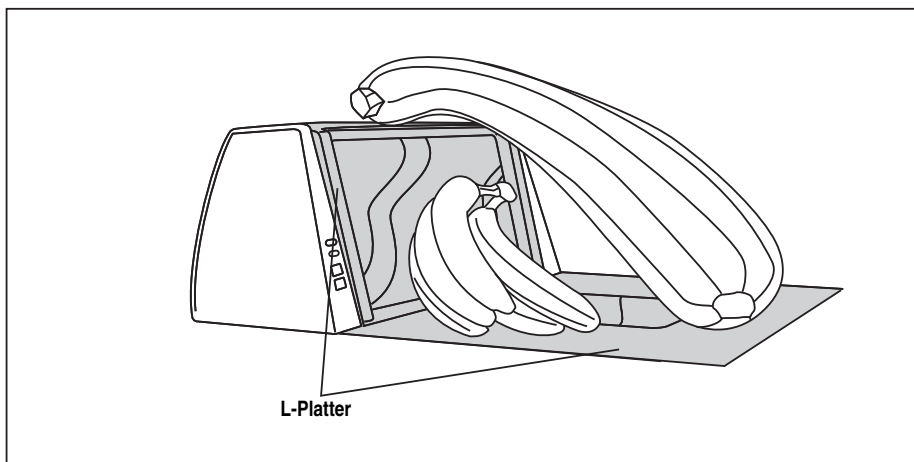

2. Once weighed items are in place, enter PLU (price Look-Up) data as described in your POS system instructions. Item weight is displayed on the Remote Display and/or the host display.
3. Remove the item from the weigh platter.

Operational Controls

The function of scanner and scale controls and indicators is listed in Appendix A, *LED/Beeper Indications & Controls*. Turn to that appendix for full details.

Operational Modes

The scanner or scanner/scale features a number of modes that are important to both the user and the system support personnel. These modes can be combined into three groups: pre-operational, operational; and additional functions. The following text describes these modes, what they mean, and how and when they are seen.

Power-Up/Selftest & Pre-Operation

Pre-Operation describes those steps that must be successfully completed before the scanner sounds the initial good read tone and illuminates the lamps indicating the scanner and/or scale are ready for operation. These steps include Power-Up Selftest, Error Reporting, and Operational Configuration.

Power-Up/Selftest

Power-Up Selftest begins when power is applied. The scanner's software immediately begins the testing sequence to verify that all systems are functioning properly. This routine, which only takes a few seconds, checks all the functions of the scanner, scale, remote scale display and interface prior to indicating that it is ready for operation.



NOTE

A tone indicating Selftest is complete is a configurable feature. See the topic *Power-up Beep Control* in the Programming section of this manual.

Error Reporting

If a fatal error is detected during Selftest or operation, the unit will not advance to Normal Operation Mode. Selftest diagnostics will cause the unit to sound a long, low tone and/or display an error message on the 7-segment display (see Figure 4-1) indicating where the failure occurred. These messages are coded to assist the repair technician in identifying the failed component. If an error is indicated, make note of it and contact your supervisor or technical support representative. A table containing descriptions of these error codes is included in Section 4, *Problem Isolation* on page 4.

If a non-fatal¹ error is detected (such as the loss of one of the two lasers), the unit will sound a long, low tone and display a number on the 7-segment display. The unit will advance to Normal Operating Mode, but performance may be affected until a correction or repair is made.

Operational Configuration

Once Selftest diagnostics have been successfully run, a tone is emitted (if configured to do so, and the unit enters an operational configuration state. The scanner or scanner/scale will automatically load your specific interface settings which are required to communicate with the host system. There are two conditions that must be met before the unit can enter Operating Mode:

- No bar code label can be in the scan volume while the unit is in this state. Progress is halted until the label has been removed, thereby ensuring that no extraneous bar code data is sent to the host.
- If your scanner has a scale, the scale cannot be in motion (usually caused by excessive vibration in the checkstand) for this test to succeed. A “Scale in Motion” status will be indicated by displaying a period and the applicable weight unit (lb . lb) or kg (. kg) that is selected.
- The scale must be able to “capture” zero weight. The - 0 - display will be seen if there is a weight on the platter at power-up. Removing the weight or pressing the Scale Zero Push Button should allow the scale to find zero.

1. Scanner behavior under non-fatal error conditions is configurable. See Section 6, *Programming* for more details.

- When the scanner or scanner/scale completes its Selftest successfully, it emits a power-up tone (when configured to do so) and enters Operating Mode.

Operating Mode

Operating Mode includes Normal Operation (scanning and weighing) and Sleep Mode. These two modes are most commonly observed by the user/operator.

Normal Operation

This condition is indicated by the green light being on dim and steady. For scanner/scale models, the yellow light indicates that the scale senses a weight of zero on the platter. If you have a scanner without scale model, the yellow lamp will not be lit when the scanner is ready for scanning.



NOTE

Yellow and Green LED indications are configurable. Your scanner may not be programmed to operate in the standard manner described above.

Once the scanner enters Normal Operation, it begins a countdown sequence. If there is no activity during a preset period of time (also called timeout¹), the unit will shut off the laser and/or motor in order to prolong the life of the electrical and mechanical components. Once the scanner has timed out, it enters Sleep Mode.

Sleep Mode

After the scanner has been left idle for a preset period of time, the laser and/or motor automatically turns off (goes to sleep). This state is called Sleep Mode, and is indicated by a “slow” blink of the green light (blinking at a 2-second rate). To wake up the unit, press anywhere on the weigh platter (scanner/scale models only), press the Volume Selection switch, press the trigger of an attached handheld scanner, or wave your hand in front of the vertical window. The unit will recognize any of these signals as a wake-up call and instantly return to Normal Operation.

1. “Timeout” and “Sleep Mode” time delays are programmable features that can be selected through use of the programming labels included in Section 6, Programming.

Additional Functions

Additional scanner and scale functions include programming, running scanner or scale diagnostics, initiating a reset, zeroing the scale, and calibrating the scale.

Programming

When your scanner or scanner/scale is shipped from the factory it is configured to work with the POS system interface at your store and read the bar code symbologies you designated. If you need to change this configuration information for any reason, Section 6, *Programming*, contains special bar code labels for changing the unit's settings.

Diagnostic Mode

Refer to Section 2, *Diagnostic Modes* for details about running scanner and scale diagnostics. *Error Codes and Corrective Action* in Section 4 provides a table of error codes resulting from diagnostics.

Scanner and Scale Reset

The reset procedures and indicators are identical for scanner and scanner/scale models. As with any electronic equipment, it is sometimes necessary to reset the electronics. The reset procedure allows you to initiate a reset command to the scanner. This may be necessary if the POS terminal has been switched off or the store system has been reset while the unit is on. Reset can also be used to initiate and run the unit's internal Selftest routine.

Pressing and holding the Volume/Tone Push Button for approximately ten seconds initiates a reset, which is sounded by a rapid number of beeps. If the motor had been spinning, the lamps will blink while the motor spins down. At that point, the motor will spin back up and the scanner will continue to run the Selftest diagnostics. For more information, see the topic, *Power-Up/Selftest & Pre-Operation* earlier in this section.

Scale Adjustments

The scale allows two user adjustments: zeroing and calibration. The first, and most frequently performed, is 'zeroing' the scale. This operation resets the scale's "at rest" reading to zero which must be within the range of - 0.2 pounds (- 1.25 grams) to +0.6 pounds (0.27kg) since the last calibration. While the 'at rest' reading remains within the zero range, the scale will automatically adjust itself to true zero. The scale also automatically zeros itself on power-up if the weight present on the scale is within these defined limits.

Zeroing the Scale

The zeroing operation may be performed by cashiers and other store personnel. Pressing and releasing the Scale Zero Push Button should return the scale to Normal Operation. If the zero point moves out of the zero range due to debris accumulation or other causes, pressing the Scale Zero Push Button will not reset the zero point. In this case the weigh platter must be cleaned, debris chutes cleared of debris or the scale must be recalibrated.

With the scanner/scale powered-up and at operating temperature:

1. Remove everything from the weighing surface of the scanner/scale.
2. Press the Scale Zero Push Button. (See Figure 1-1).
3. The Zero¹ light will turn on and the display will show 0.00 lb (0.000 kg). If it does not, see Section 4, *Problem Isolation*.
4. You have completed the scale zeroing function.

Calibrating the Scale

The second adjustment, calibration, defines and sets a standard reference weight range against which all product weights are compared. If your scale is set for weighing in pounds, this range is 0 - 30 pounds, and, if your scale is set for weighing in kilograms, the range is 0 - 15 kilograms. The scale must be calibrated upon initial installation, whenever the scale cannot be zeroed, when the scale diagnostics indicate a calibration error, when the weighing measure (pounds or kilograms) is changed, or when the scale module has been replaced.

1. Zero light operation is configurable.

Normally, once the scale has been calibrated, the calibration must be verified and/or approved by a local regulatory body. In many areas of the United States, the scale calibration switch must be sealed before being placed into service. Consult the agency responsible for regulating weighing devices in your area to ensure that you are meeting all legal and regulatory requirements. Section 5, *Calibration*, describes the calibration sequence and verification process.

Calibration can only be performed if the tamper seal that secures access to the Calibration Switch is broken and the switch cover is removed. Breaking the seal may *legally* render the scale inoperable until it has been recertified and a new seal attached. Consult your local regulations before removing the calibration seal if you are unsure of the legal requirements. Although the scale will physically continue to weigh products, a broken seal may require recertification by a proper authority as designated by your local laws.

Operational Maintenance

The scanner or scanner/scale will provide dependable service for many years. The following maintenance procedures will keep your scanner or scanner/scale operating at peak performance.

Cleaning the Weigh Platter and Scan Windows. Clean the exterior surfaces of the horizontal and vertical scan windows at least twice daily with a nonabrasive, mild, water-based glass cleaner and paper towels or lint-free cleaning tissues. The textured plastic surfaces and stainless steel can also be cleaned using the same cleaning agents.

Cleaning the Air Gap/Debris Chutes & Drip Rail. Daily, clear the debris chutes (see Figure 2-3) between the platter and the outer housing. Most items can be cleared from the debris chutes by carefully running a thin stiff object like a credit card along all sides of the weighing surface. If necessary, remove the top cover to clear the debris chutes and drip rail.

Vertical Scan Window Replacement

The Vertical Scan Window enclosed in the All Weighs™ Platter is a replaceable part. Follow these instructions to remove and replace the window:

To remove the Vertical Scan Window:

1. Grasp the top edge of the platter, tilt slightly and lift off vertically (see Figure 3-3a). If the top edge is blocked, insert a coin into one or both indentations along either side of the platter and pry gently to lift the platter edge. Grasp the raised sides and carefully lift the platter off as shown in Figure 3-3b.

Figure 3-3. Platter Removal

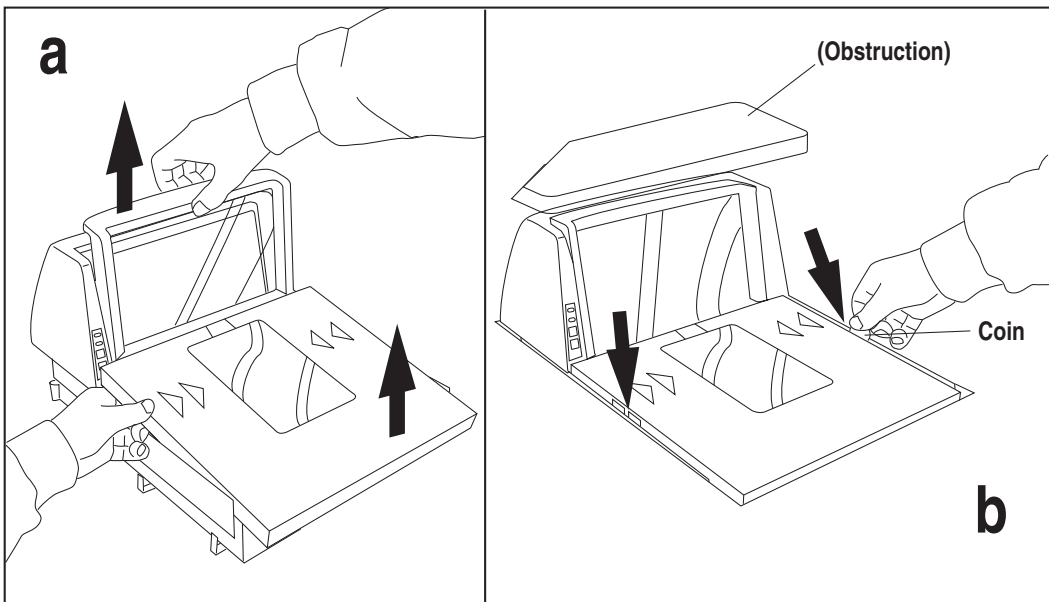

NOTE

Use caution to avoid damage to the now exposed horizontal and vertical scan windows. If cleaning of these windows is necessary, use a nonabrasive, mild, water-based glass cleaner and paper towels or lint-free cleaning tissues and take care to avoid scratching these windows (damage to the windows can degrade scanning performance).

2. The vertical bezel cover is held in place by tabs along its top and side edges. To remove it, carefully lift up on the top edge as shown in Figure 3-4a, tilt it out and snap it off.
3. Lift out the vertical window. Carefully dispose of any damaged glass.

Figure 3-4. Vertical Scan Window Removal/Replacement

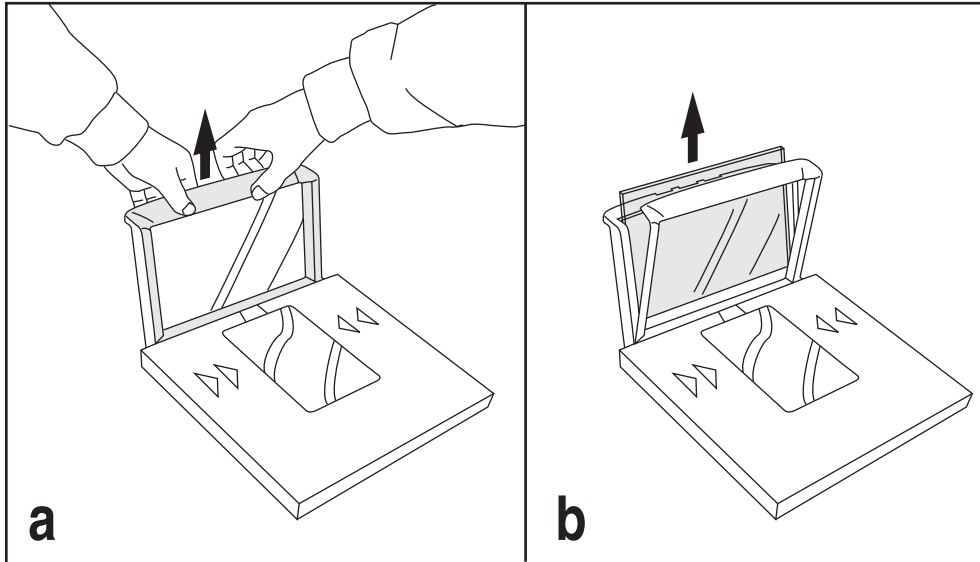

4. Fully seat the new vertical scan window into the window channel.
5. Align the vertical bezel cover with the assembly. Press firmly along the top and sides to engage the tabs and secure it in place.
6. Clean both sides of the new vertical scan window using a paper towel or lint free cleaning tissues dampened with a mild, water-based glass cleaner. DO NOT use abrasive cleaners or pads.
7. Re-install the platter. Vertical scan window replacement is now complete.

Horizontal Scan Window Replacement (WRG)

Wear Resistant Glass (WRG) horizontal scan windows are replaceable and can be removed and replaced following the instructions below.



NOTE

Sapphire glass does not require replacement, so it is permanently fastened in place. Do not attempt to remove Sapphire glass from the platter.

1. Remove the All Weighs™ Platter from the scanner as shown in Figure 3-3.
2. Turn the platter upside down on a clean, dry surface and remove the two screws shown in Figure 3-5. Retain the screws for later re-installation.
3. Once the retainer is freed from the platter, tilt out the retainer and remove the WRG window as shown. Carefully dispose of any damaged glass.
4. Seat a new WRG window in the cavity.
5. Re-install the retainer using the original two screws.
6. Clean both sides of the new WRG window using a paper towel or lint free cleaning tissues dampened with a mild, water-based glass cleaner. DO NOT use abrasive cleaners or pads.
7. Re-install the platter. WRG window replacement is now complete.

Figure 3-5. Removing/Replacing the WRG Window

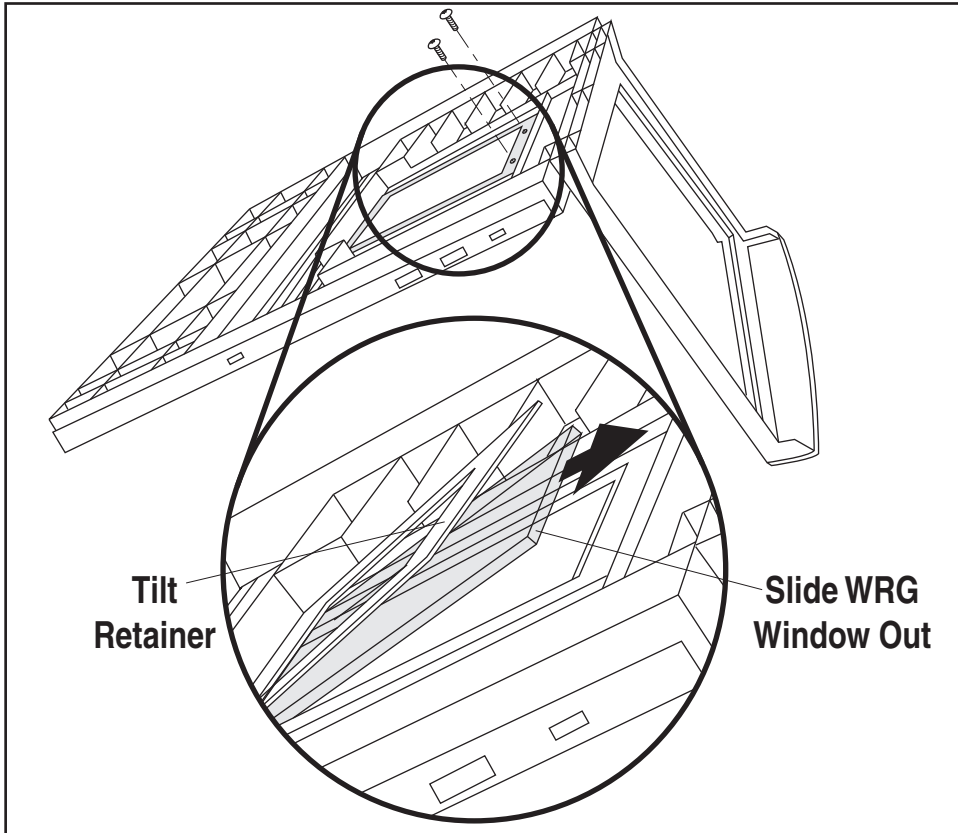

Section 4

Problem Isolation

In the event of a suspected functional problem, use the troubleshooting references provided in this section. This useful information will help you to identify and resolve the cause of the problem.

The scanner/scale has a number of features that indicate when a scanner or scale problem occurs. The unit may:

- emit a series of tones
- light the 7-segment Field Replaceable Unit (FRU status) display
- flash the Green and/or Yellow LEDs
- display error codes on the Remote Display (if installed)

Three error reporting modes are used: Power-Up Selftest, Operational tests and Diagnostic tests. These test sequences are explained on the following pages.

Power-Up Selftest

The Power-up Selftest is a pre-operational series of tests that must be successfully completed before the scanner indicates readiness for operation. This pre-operational period is the time between power-up and normal operation during which the motor comes up-to-speed and software, firmware and hardware are being tested. These tests ensure that all subsystems are fully functional before turning on the Visible Laser Diode (VLD). Refer to the Section 3 subsection titled, *Operational Modes* for a more detailed description of this and other scanner and scale modes.

Operational Tests

These are the tests that run continually during Normal Operation and Sleep Mode. Firmware checks all subsystems, accessory connections and the POS interface to verify everything is operating normally. If a problem is detected at any time, a long, low tone is sounded, an error code is shown on the 7-segment display, and operation may be halted. If you press the Volume/Tone Push Button at that time, a series of tones will be sounded that matches the error code displayed.

Diagnostic Tests

See Section 2, *Diagnostic Modes*, for details about running diagnostic tests for the scanner and/or scale. If a problem is discovered during diagnostics, the scanner will provide feedback about the source of the problem. The remainder of this section describes these failure indications and includes troubleshooting flowcharts to help isolate the problem.

Diagnostic Procedures

Your Point-Of-Sale (POS) system may contain many components that operate as a system. Since almost all scanner or scale problems are caused by either the scanner, scale, POS terminal or communication links between them, these troubleshooting flowcharts focus on these components. Additionally, the optional Remote Scale Display, AC/DC Power Supply and their cables are potential problems addressed in this section.

The flowcharts provided in this section walk you through a diagnostic process that will isolate the failed component and instruct as to the corrective action required. Since internal scanner and scale components cannot be replaced by an operator or installer, most functional errors will require the assistance of a trained technical support person. However, if the problem is caused by faulty cable, power supply or remote display, you can fix the problem by replacing the defective component and complete the installation.

Error Codes

If an error is detected, the scanner will sound a long low tone (for three seconds) and alternately flash its LEDs, indicating a failure. When this occurs, press the Volume/Tone Push button to display the error code on the 7-segment display (refer to Figure 4-1). The scanner will also sound a series of beeps corresponding to the error code. The table below describes what these codes mean and what action should be taken for each.



When troubleshooting, always remember to check all cable connections first before proceeding with other problem isolation steps.

Table 4-1. Error Codes and Corrective Action

Error Code	Probable Cause	Corrective Action
0 Blinking	Configuration	No POS interface has been selected (Null interface). See the topic, <i>Interface Type</i> , in Section 6 to select the required interface using programming bar codes.
1	Configuration Error	See Section 6, <i>Programming</i> , for details about configuring the scanner using programming bar codes.
2	Digital Board	Unplug unit and call technical support personnel.
3	Motor	Unplug unit and call technical support personnel.
4	Laser	Call technical support personnel.
5	Laser	Call technical support personnel.
6	Digital Board	Unplug unit and call technical support personnel.
7	Scale	See the topic <i>Scale Error Reporting</i> in this section for problem identification and corrective actions.
8	Remote Display	Connect the Remote Display. If necessary, replace display or cable. Alternatively, you can disable the Remote Display using the programming procedures described in Section 6.
A	Button Module	Call technical support personnel
C	Scale Calibration	Proceed to Section 5, Calibration
Decimal Point	3.3 V Present	If not lit, call technical support personnel

Figure 4-1. 7-Segment LED Display

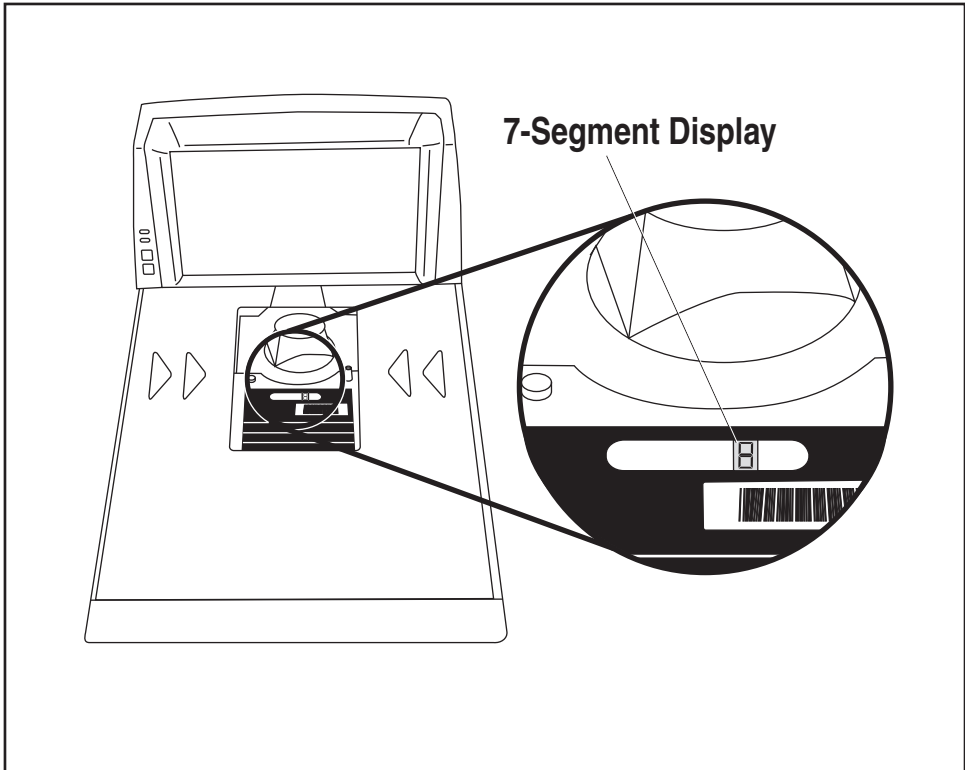

Scale Error Reporting

Scale diagnostics uses the Remote Scale Display and the Zero Status lamp to communicate specific scale failures. The following chart shows the Remote Display messages, the Scale Status lamp indication, the problem that the scale is experiencing and what action should be taken. When troubleshooting, always remember to check all cable connections first before proceeding with other problem isolation steps.

Table 4-2. Scale Error Reporting

Remote Display	Scale Status Lamp	Problem Description	Action Required
E_1	Flash, pause, 1 blink, long pause, repeat sequence.	Too much motion at power-up.	Check for stable installation. Change scale motion filter using the labels found in Section 6; restart. If problem persists, scale may require calibration.
E_2	Flash, pause, 2 blinks, long pause, repeat sequence.	Calibration lost.	Call technical support personnel. Recalibrate; restart; recertify (if required).
E_3	Flash, pause, 3 blinks, long pause, repeat sequence.	Scale communication lost. Internal scanner/scale problem.	Call technical support personnel; report error.
E_4	Flash, pause, 4 blinks, long pause, repeat sequence.	Scale module failure.	Call technical support personnel; report error.
E_5	Flash, pause, 5 blinks, long pause, repeat sequence.	Internal software fault.	Call technical support personnel; report error.

Table 4-2. Scale Error Reporting

Remote Display	Scale Status Lamp	Problem Description	Action Required
Other Scale Reporting			
- 0 -	Off	Cannot zero at power- up or weight remains on scale for more than 4 minutes or weight has not returned to zero between POS weight requests ^a .	<ul style="list-style-type: none">- Check debris chutes.- Verify that the weigh platter moves freely.- Remove item(s) from scale- Press Scale Zero Push Button for more information.- If the scale still fails to zero, recalibrate the scale.
___---	Off	Over- and underweight conditions.	<ul style="list-style-type: none">- Remove all weight from scale- Rezero.

a. This is a configurable feature.

Flowcharts

The problem isolation flowcharts on the following pages allow you to identify and troubleshoot problems with your system.

Figure 4-2. Problem Isolation: Start

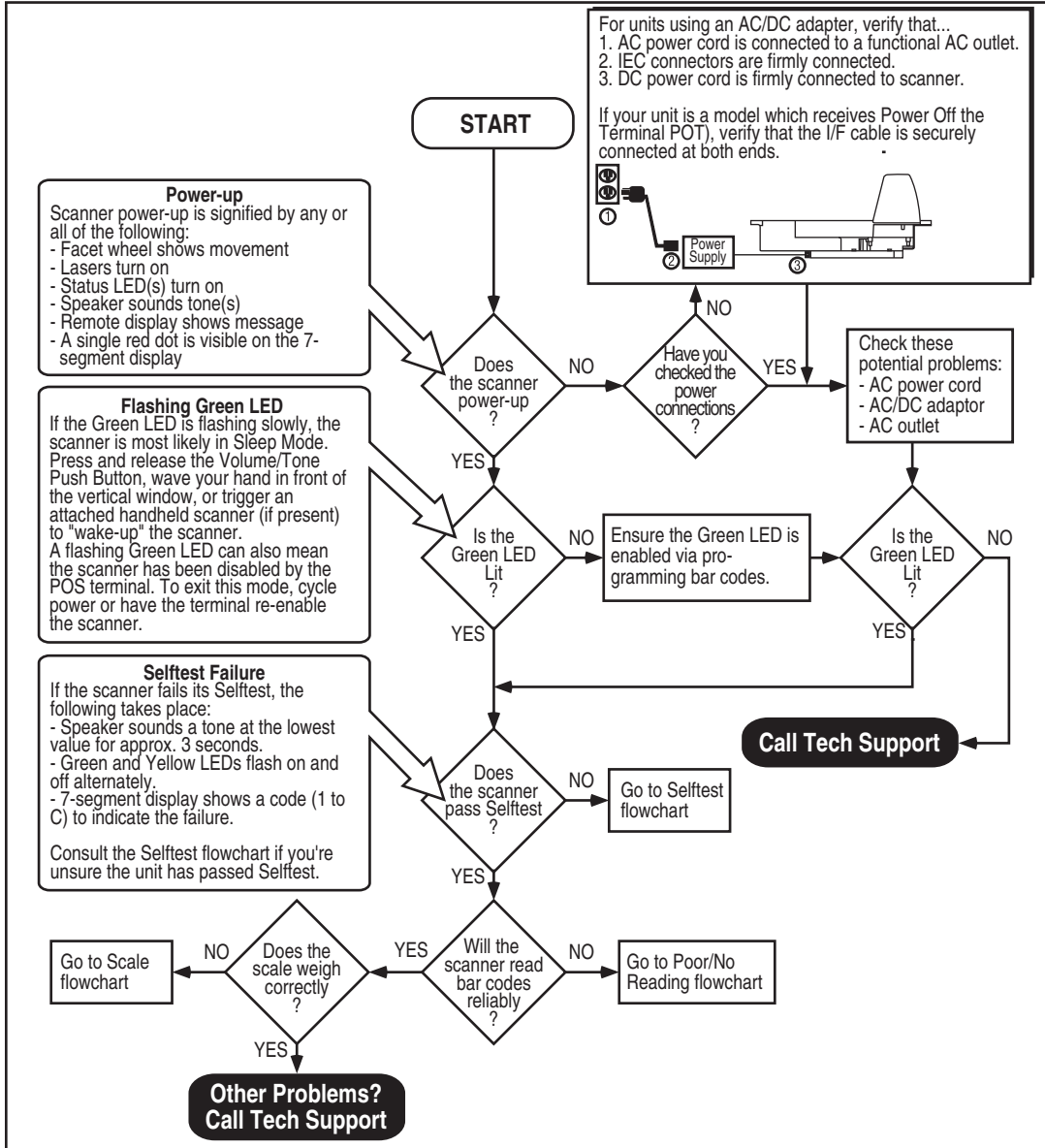

Figure 4-3. Problem Isolation: Selftest

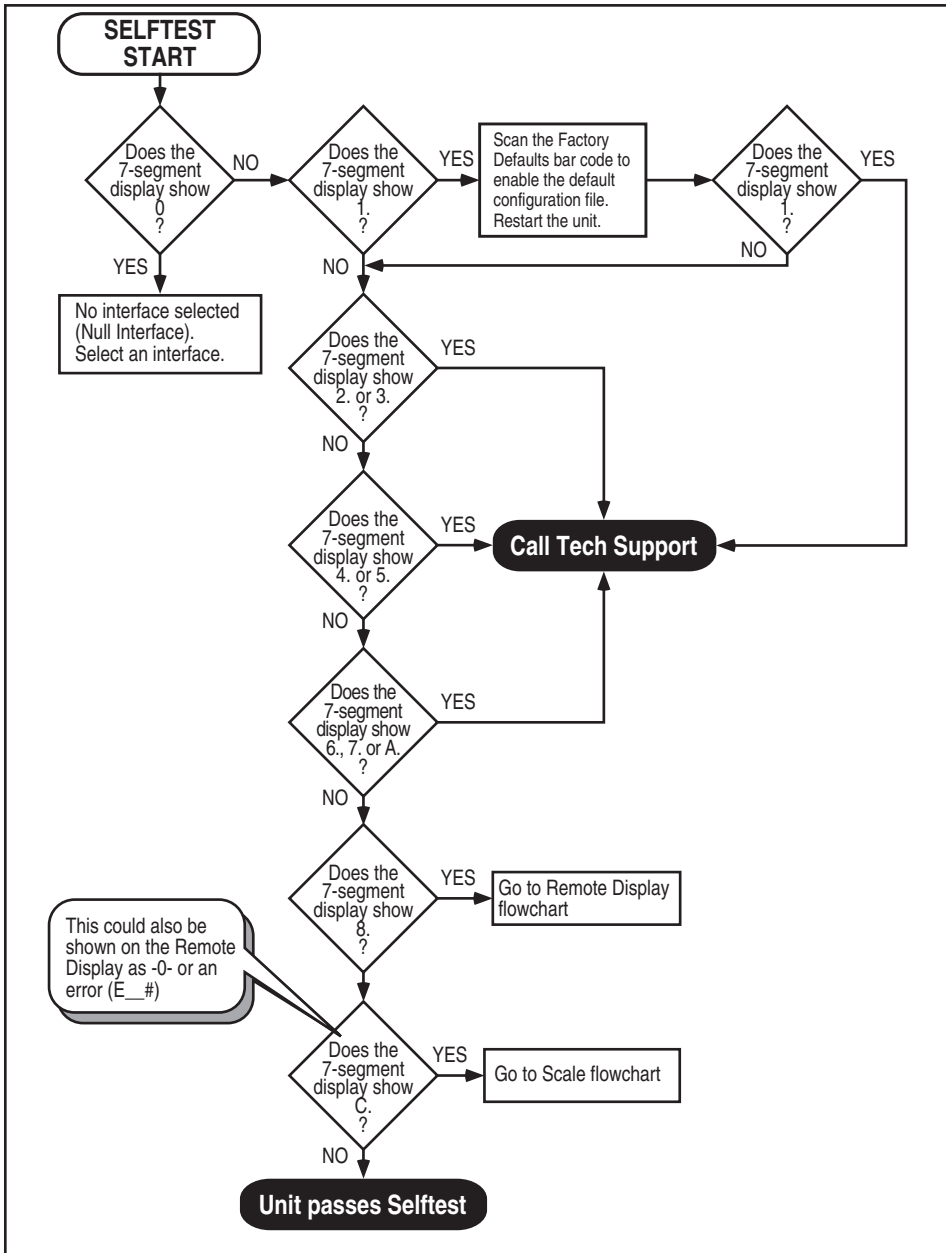

Figure 4-4. Problem Isolation: Poor/No Reading

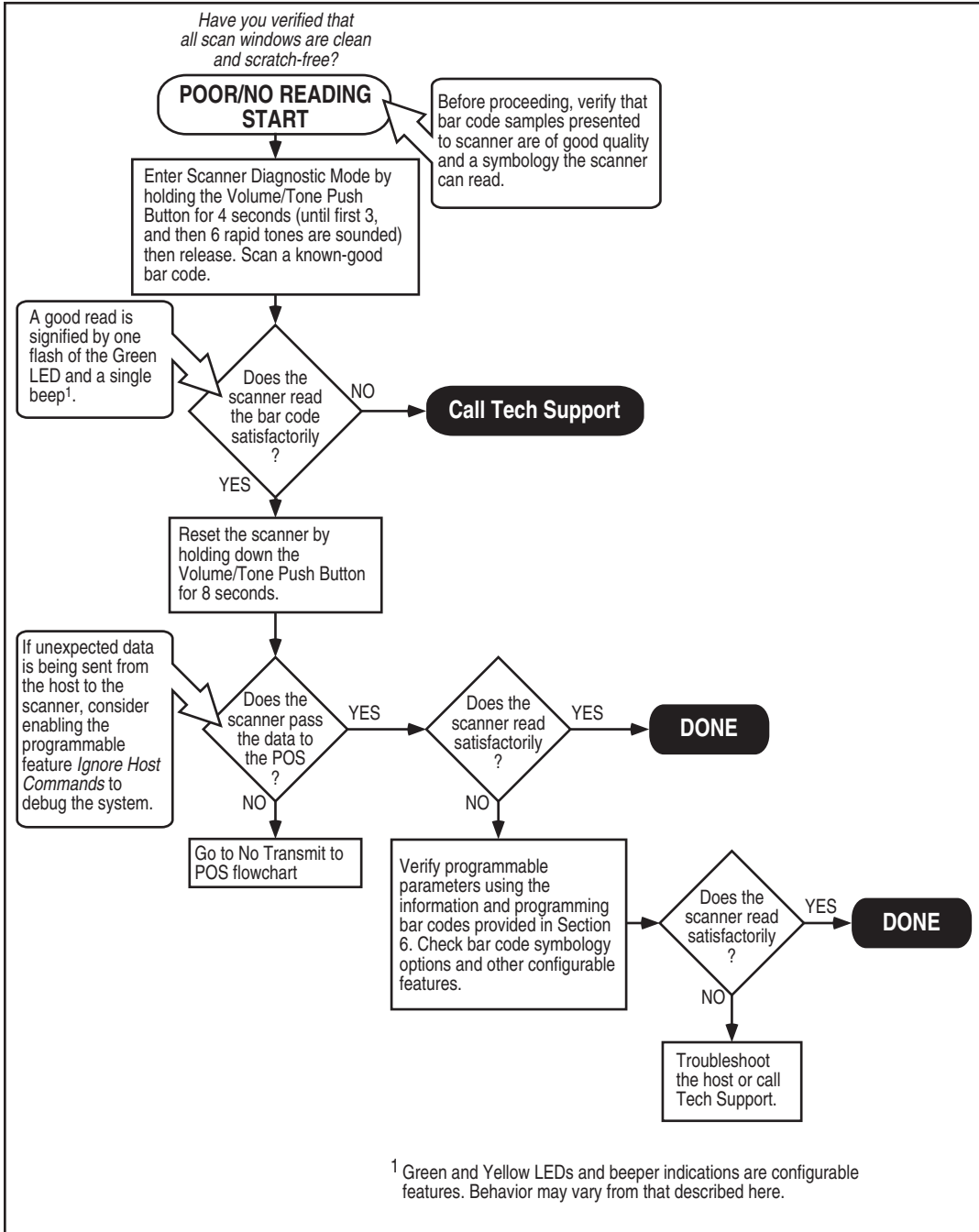

Figure 4-5. Problem Isolation: No Transmit to POS

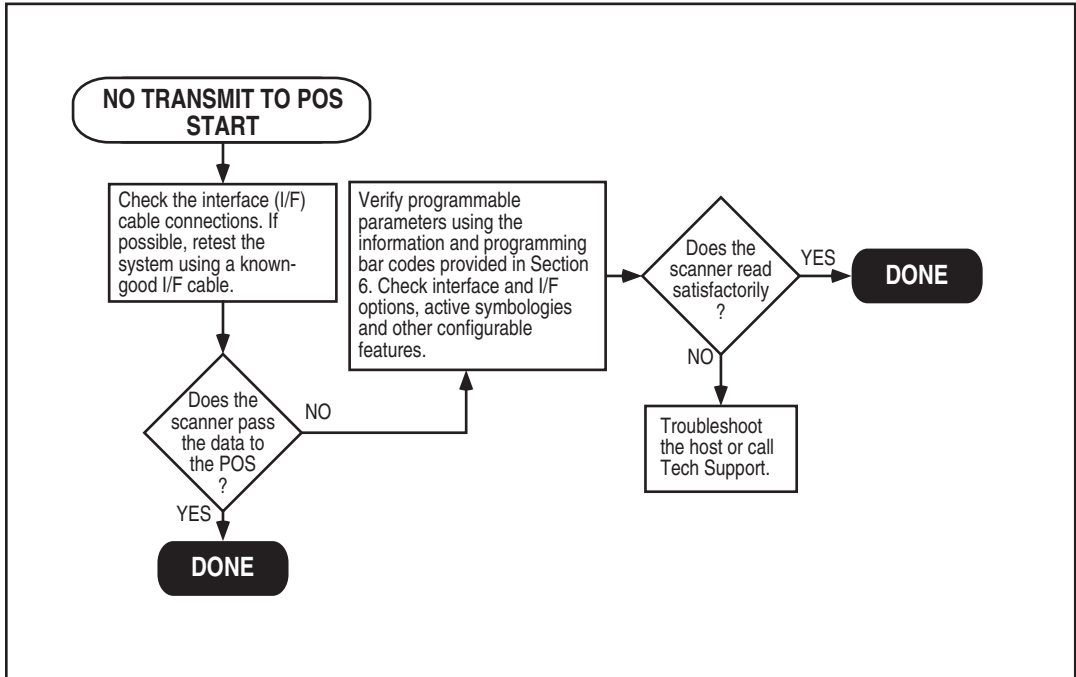

Figure 4-6. Problem Isolation: Scale

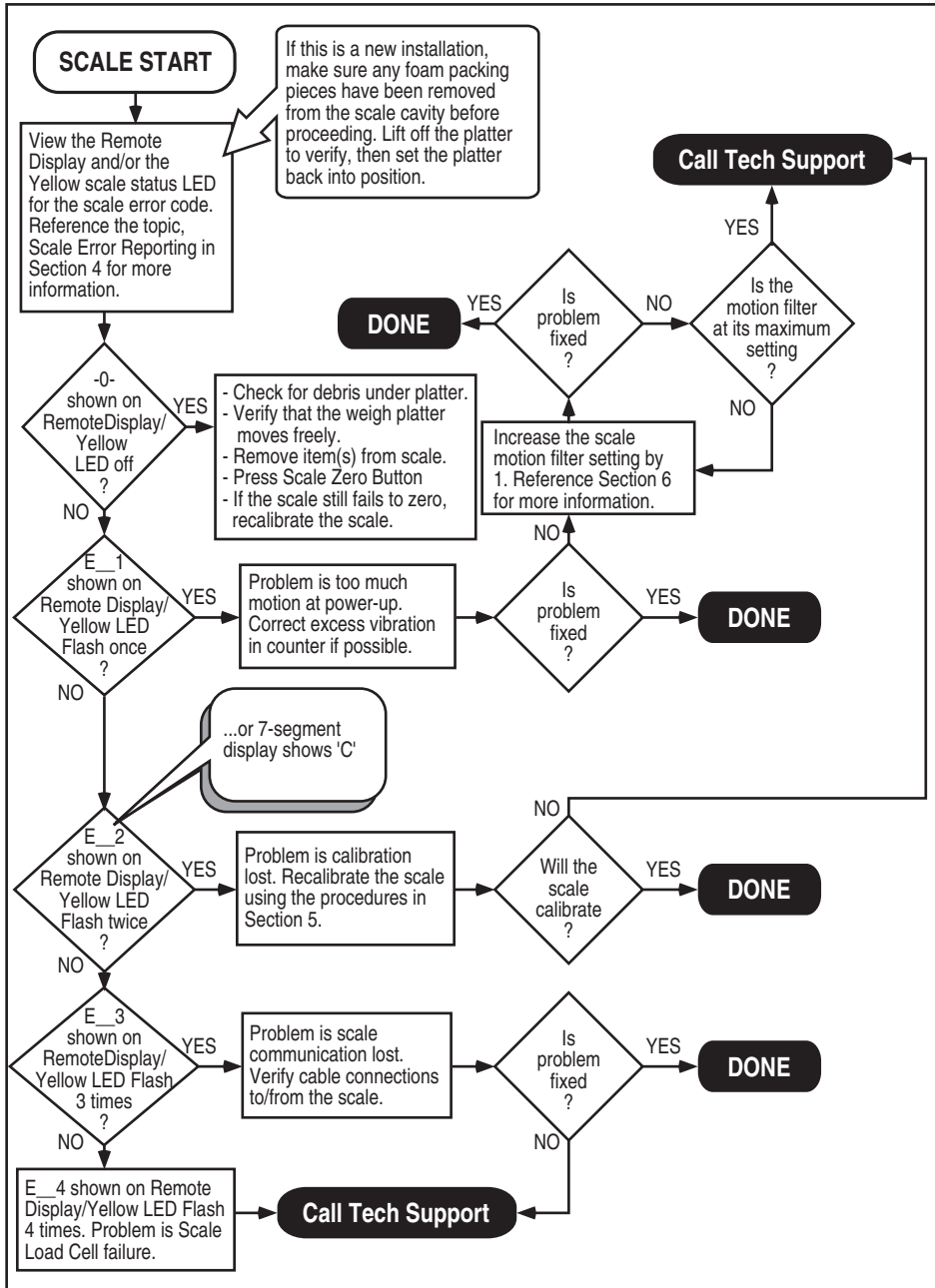
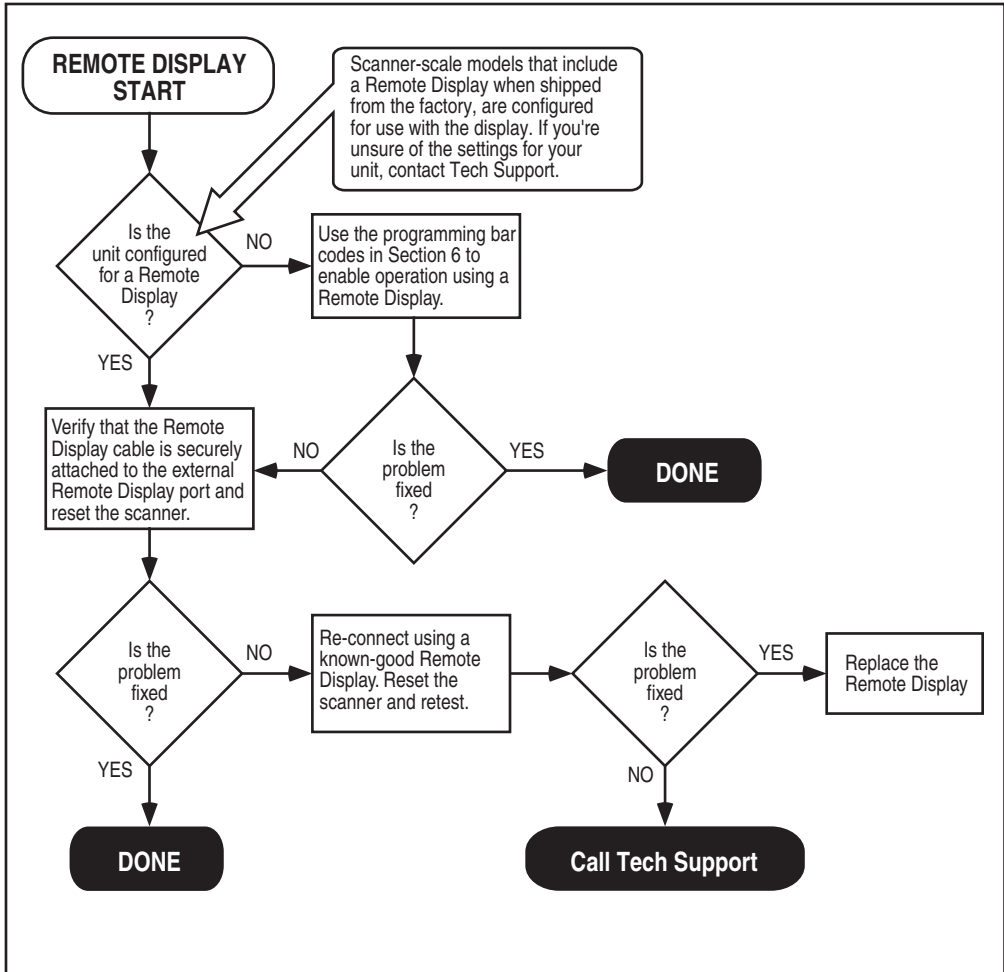

Figure 4-7. Problem Isolation: Remote Display



NOTES

Section 5

Calibration

A number of situations require the scale to be calibrated. They are:

- at initial installation of the scanner/scale
- if the scale cannot be re-zeroed
- if you change the weight measure from pounds to kilograms or vice-versa
- if diagnostics indicate a calibration error
- the weigh module has been replaced

Follow the procedures on the following pages to ensure that the scanner/scale will meet Weights and Measurement requirements.

LEGAL NOTE

Certification of the scanner/scale's weighing apparatus is subject to Federal, State and Local Weights and Measures statutes and is restricted to authorized government agencies and/or duly registered agents thereof. Anytime a scale is calibrated, it should be properly sealed with a lead and wire or paper seal before being placed into service.

It is your responsibility to check with the appropriate authorities in your area to ensure compliance with pertinent regulations before removing any official seals or placing a newly calibrated scanner/scale into service.

Description of Calibration Sequence

The Calibration Sequence sets the scale to an accurate reference point for weighing. This process involves the use of a Field Standard Weight Set (31.5-pounds) for calibration in pounds, (18.5-kilograms) for Metric. Once calibration has been successfully completed, the scanner/scale uses the certified weight as a reference for subsequent weighing activities.

These verification procedures follow the *U.S. National Institute of Standards and Technology 44 Handbook* guidelines for bench/counter scale installations.

If any of these tests fail to meet the required weight indications, you must calibrate the scanner/scale. Refer to the calibration procedures in this section for the proper procedures.

You may be required by state and/or local regulations to have procedures other than these performed by a certified technician or verification official.

Access to the calibration switch should be restricted with a paper or a wire and lead seal after the calibration has been performed if required by your local regulatory agency.



NOTE

The Calibration Sequence must be performed without removing the scanner/scale from its installed position.

The following tools and supplies will be required to perform the calibration process:

- 31.5 pound Field Standard Weight Set¹.
(English calibration only).
- 18.5 kilogram Field Standard Weight Set².
(Metric calibration only).
- Lead/Wire or Paper Seal (as required by law).

1. NOTE: Throughout the calibration procedures, specified weights may be achieved by using a combination of weights from this set. *eg.* 20 lbs may be made up of one 10.00 lb. weight and two 5.00 lb. weights.

2. NOTE: Throughout the calibration procedures, specific weights may be achieved by using a combination of weights from this set. *eg.* 10 kgs. may be made up of one 5.00 kg. and five 1.00 kg. weights.

Motion Test

This test verifies that the scale will not ‘zero’ when the weighing surface of the scanner/scale is in motion.

1. Verify that the Yellow LED¹ is on and the Remote Display reads 0.00 pounds or 0.000 kilograms.
2. Press lightly on the weigh platter of the scanner/scale with one hand and at the same time press and release the Scale Zero Push Button on the operator’s panel. The Yellow LED should turn Off and the Remote Display should not display 0.00 pounds or 0.000 kilograms.
3. Remove your hand from the weighing platform and verify that the Yellow LED is On and the Remote Display reads 0.00 pounds or 0.000 kilograms.

Automatic Zero Setting Test

This test verifies that the scanner/scale automatic zero setting mechanism is operating correctly.

1. Place 0.007 pounds (4 grams for metric) on the center of the weighing platform. The entire weight must be placed on the weighing platform at once for this test to be valid. The Yellow LED should go Off and the Remote Display should read 0.01 pounds (0.005 kilograms).



NOTE

The scanner/scale has an adaptive zero capture mechanism that re-zeros the scale over time if there is a slow change in the zero level; thus if all the weight is not placed on the weighing surface at one time, the Yellow LED will remain On and the Remote Display will read 0.00 pounds (0.000 kilograms). When the weight is removed, the Yellow LED will turn off and the display will show a minus sign - . lb. Press the Scale Zero Push Button to re-zero the scale.





1. Yellow LED indications can be configured via feature programming and may not be enabled for certain functions.

Preparing the Scanner/Scale for Calibration

1. Assure that the scanner/scale is stable, secure and properly installed. (Refer to Section 2, *Site Preparation and Installation* for instructions on the proper installation of the scanner/scale).
2. Power-up the scanner/scale.
3. Allow the unit to reach temperature equilibrium for at least one hour. If the scanner/scale is already at room temperature, allow at least 15 minutes for acclimatization.
4. Before performing the calibration, the scanner/scale must be pre-stressed with a weight of more than 30 pounds (15kg). With power turned on, place the entire weight set (including the case) on the weighing surface of the scale. The display should show an underscore and three hyphens , which is the over-weight indication.
5. Remove all weight from the weighing surface and ensure that there are no obstructions in the debris chutes of the scanner/scale. See Figure 5-1.

Calibrating the Scale (Pounds & Kilograms)

1. Before proceeding, ensure that the scanner/scale has been prepared for this process by performing the preceding steps titled, *Preparing the Scanner/Scale for Calibration*.
2. Remove the weigh platter and make sure that there are no obstructions in the debris chutes.
3. Cut and remove the seal that secures the calibration switch access cover and remove the cover. This seal may not be present if this is the initial installation of the scanner/scale.
4. Locate the calibration switch (See Figure 5-1).
5. Press and release the Calibration Switch to place the scanner/scale in Calibration Mode. The scanner/scale will sound a tone indicating that it is in Calibration Mode. If the motor was spinning when you initiated Calibration Mode, the motor will stop and the Yellow LED will begin flashing indicating the scale is in Calibration Mode. The display will show the message “ESCL” (empty scale).

-
6. Reinstall the weigh platter.
 7. Press the Scale Zero Push Button. The Yellow LED will go out for approximately 10 seconds (or less) and the Remote Display will alternately display  and  until the scale is ready to proceed.
 8. When the scale is ready, the Yellow LED will begin blinking again and the display will show the message “Ad20 (add twenty pounds)” or “Ad10 (add ten kilograms).” The scanner/scale will also sound one tone if the scale is weighing in kilograms or two tones for pounds. Place the correct weight (twenty pounds for calibration in pounds, or ten kilograms for metric calibration) from the Field Standard Weight set on the center of the weighing area and press the Scale Zero Push Button again.
 9. The Yellow LED will extinguish for approximately 10 seconds and the Remote Display will alternately display  and  until the scale is ready to proceed.
 10. If the calibration was successful, the speaker sounds a single tone, the Scale Status LED begins blinking again, and “End-” appears in the Remote Display.
 11. If the calibration was not successful, the speaker will sound five tones indicating a scale failure, and the Scale Status LED will blink twice, strobe (fast blinks) and then continually repeat this sequence until reset. Remove all weight from the Weigh Platter, and repeat the procedure starting with step 8.
 12. Press the Scale Zero Push Button again to permanently store the calibration data and exit Calibration Mode. You have completed the calibration of the scanner/scale. The unit’s calibration must now be verified as required by state and/or local weights and measures regulations. The verification procedure must be performed to assure that a scale will pass Weights and Measures requirements before it is placed into commercial/retail service.

You have completed the scale calibration procedure. You must now continue with the calibration verification tests to complete the scale's calibration. If you are weighing in pounds, continue with the following procedures to verify that the scale was successfully calibrated and that it weighs properly. If you are weighing in kilograms, turn to the instructions titled, *Calibration Verification (Kilograms)*, later in this section.

Figure 5-1. Calibration Control

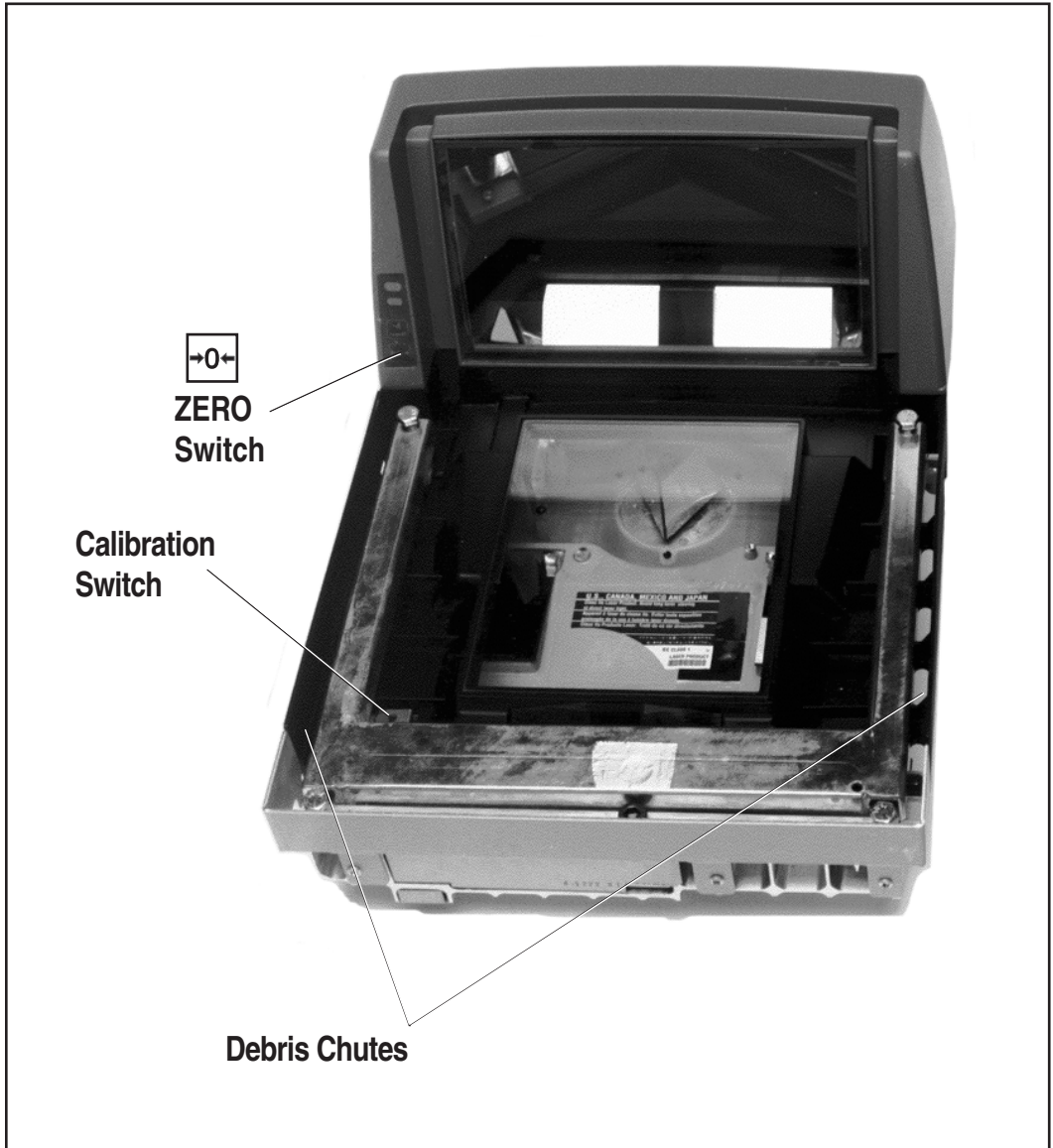

Calibration Verification (U.S. Pounds)

Once you have completed the calibration sequence, you may be required to perform these step-by-step verification procedures. These procedures follow the *National Institute of Standards and Technology Handbook-44* guidelines for grocery scale installations. You may be required by state or local law to have these procedures performed by a certified technician or verified by a proper official.

These calibration verification procedures cover five different tests:

- Increasing-Load Test
- Shift Test
- Blanking Test
- Decreasing-Load Test
- Return to Zero Test

Increasing-Load Test (Phase 1)

This test checks Scale operation with five, ten and fifteen pound weights.

1. Check that the display reads 0.00 lb. when at rest with nothing on the weighing surface. (The Yellow LED is steadily lit).
2. Place a five-pound weight on the center of the weighing surface and check that the display reads 5.00 lb.
3. Place an additional five pounds on the center of the weighing surface and check that the display reads between 9.99 and 10.01 lb.
4. Place an additional five pounds on the center of the weighing surface and check that the display reads between 14.99 and 15.01. Remove the weights and verify that the display reads 0.00.
5. You have completed the Increasing-Load Test (Phase 1).

Shift Test

The Shift Test checks to ensure that items placed anywhere on the weighing surface of the scanner/scale are weighed properly. Refer to Figure 5-2 when performing this test.

1. Place and remove a fifteen-pound load on the center of each of the four quadrants (A, B, C, and D in Figure 5-2) of the scanner/scale's weigh platter in succession. Verify that a reading of between 14.99 and 15.01 lb registers under load and that the display returns to 0.00 between each load.
2. After verifying the accuracy of each quadrant of the weighing surface, remove all weight from the scale. You have completed the Shift Test.

Figure 5-2. Shift Test

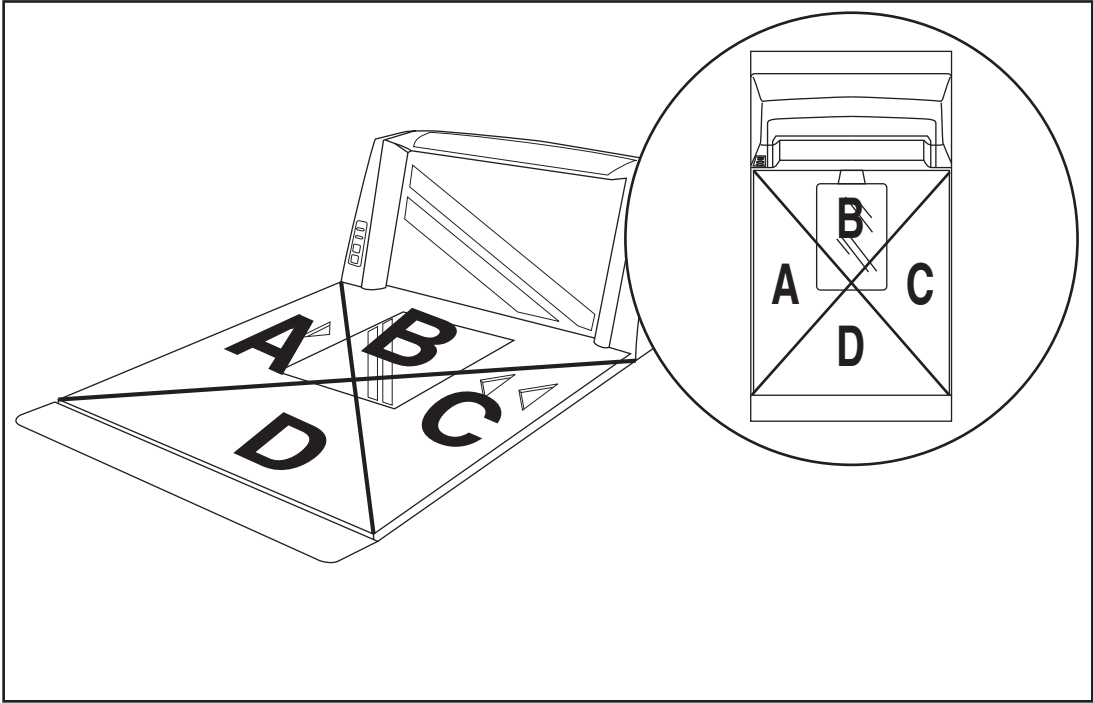

Increasing- Load Test (Phase 2)

After completing the Shift Test, you must complete the Increasing Load Test using 20.0, 25.0 and 30.0 pounds of weight.



NOTE

The upper limit of the scale is configurable according to POS interface type and may not necessarily be set at 30 pounds, which is the standard setting. For this test, continue to place weights in five pound increments only up to the upper weight limit set for your scale.

1. Place 20.0 pounds in the center of the weighing surface and check that the display reads between 19.99 and 20.01 lb.
2. Place an additional five pounds in the center of the weighing surface, increasing the load to 25.0 pounds and check that the display reads between 24.99 and 25.01 lb.
3. Place an additional five pounds in the center of the weighing surface increasing the load to 30.0 pounds and check that the display reads between 29.99 and 30.01 lb.
4. Remove the weights and verify that the display reads 0.00.

Blanking Test

This test ensures that the scanner/scale will indicate its weighing capability has been exceeded if a weight greater than 0.05 pounds over its maximum upper weight limit is placed upon the unit.

1. Place weights that total the upper weight limit plus 0.51 pounds on the scale. For example: If the upper limit is set at 30 pounds, place weights equaling 30.51 pounds.
2. Verify that the display shows a dash and three hyphens (_ - -). This is the overweight indication.



NOTE

The scanner/scale may blank (show an underscore and three hyphens) at any weight greater than its upper limit, but must blank when the upper limit plus 0.51 pounds are set upon the weighing surface.

Decreasing-Load Test

This test ensures that the scanner/scale responds properly when a heavy object is followed by a significantly smaller object.

1. Place a 30.0-pound load on the scale and verify that the display shows between 29.99 and 30.01 pounds.



NOTE

If the upper weight limit for your scale is not set at 30 pounds, begin by placing weight equaling your upper limit setting.

2. Remove weights to leave 20 pounds on the scale. Check that the display shows between 19.99 and 20.01.
3. Remove another 15.0 pounds from the scale and check that the scale reads 5.00 lb.
4. You have completed the Decreasing Load Test.

Return to Zero Test

This test ensures that, after all other tests have been completed successfully, the scanner/scale returns to zero. Remove all weights from the scale and verify that the scale reads 0.00 lb.

After completing this test, close the calibration access cover and seal per local Weights and Measures requirements. This final step must agree with the legal requirements of your state or local government.

You have completed the calibration and verification process for weighing in pounds.

If the scanner/scale passes all these tests,

1. Remove the weigh platter, install the calibration switch cover and install a seal (if required).
2. Reinstall the weigh platter.

If the scanner/scale fails any of these tests, it should be serviced by a qualified technician.

Calibration Verification (Kilograms)

Once you have completed the calibration sequence, you may be required to perform these step-by-step verification procedures. These procedures follow the *National Institute of Standards and Technology Handbook-44* guidelines for grocery scale installations. You may be required by state or local law to have these procedures performed by a certified technician or verified by a proper official.

These calibration verification procedures cover five different tests:

- Increasing-Load Test
- Shift Test
- Blanking Test
- Decreasing-Load Test
- Return to Zero Test

Increasing-Load Test (Phase 1)

This test checks Scale operation for increasing loads from 0.100 kg and 7.50 kg.

1. Check that the display reads 0.000 kg when at rest with nothing on the weighing surface. (The Yellow LED is steadily lit).
2. Place a 100 gram weight on the center of the weighing surface and check that the display reads 0.100 kg.
3. Place an additional 200 grams on the center of the weighing surface and check that the display reads 0.300 kg.
4. Place an additional 200 grams on the center of the weighing surface and check that the display reads 0.500 kg.
5. Place an additional 100 grams on the center of the weighing surface and check that the display reads 0.600 kg.
6. Place an additional 100 grams on the center of the weighing surface and check that the display reads 0.700 kg.
7. Place an additional 100 grams on the center of the weighing surface and check that the display reads 0.800 kg.
8. Place an additional 200 grams on the center of the weighing surface and check that the display reads 1.000 kg.

-
9. Increase the weight on the scale to 7.50 kg on the center of the weighing surface and check that the display reads between 7.495 and 7.505 kg.
 10. Remove the weights and verify that the display reads 0.000 kg. You have completed the Increasing-Load Test (Phase 1).

Shift Test (Metric)

The Shift Test checks to ensure that items placed anywhere on the weighing surface of the scanner/scale are weighed properly. Refer to Figure 5-3 when performing this test.

1. Place and remove a 5.0 kilogram load on the center of each of the four quadrants (A, B, C, and D in Figure 5-3) and in the center of the scanner/scale's weighing platform in succession. Verify that the display shows a reading of between 4.995 and 5.005 kg for each quadrant/center test and that the display returns to 0.000 between each load.
2. After verifying the accuracy of each quadrant and the center of the weighing surface, remove all weight from the scale. You have completed the Shift Test.

Figure 5-3. European Shift Test (Metric)

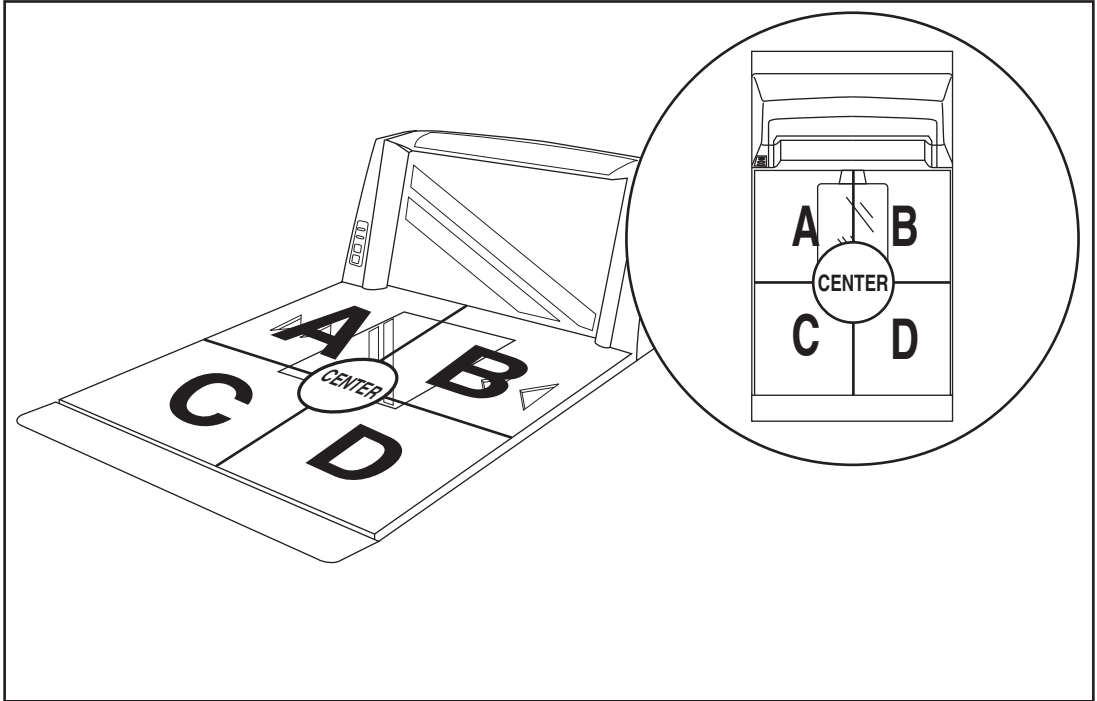

Increasing- Load Test (Phase 2)

After completing the Shift Test, you must complete the Increasing Load Test using 10.00, 12.50 and 15 kilograms of weight.



NOTE

The upper limit of the scale is configurable according to POS interface type and may not necessarily be set at 15 kilograms, which is the standard setting. For this test, continue to place weights in 2.50 kilogram increments only up to the upper weight limit set for your scale.

1. Place 10.00 kilograms in the center of the weighing surface and check that the display reads between 9.990 kg and 10.010 kg.
2. Place an additional 2.50 kilograms in the center of the weighing surface and check that the display reads between 12.490 kg and 12.510 kg.

3. Place an additional 2.50 kilograms in the center of the weighing surface and check that the display reads between 14.990 kg and 15.010 kg.
4. Remove the weights and verify that the display reads 0.000 kg.
5. You have completed phase two of the increasing load test.

Blanking Test

This test ensures that the scanner/scale will indicate its weighing capability has been exceeded if a weight greater than 0.82 over its maximum upper weight limit is placed upon the unit.

1. Place weights that total the upper limit plus 0.82 kilograms on the weigh platter. For example: If the upper limit is set at 15 kilograms, place weights equaling 15.82 kilograms.
2. Verify that the display shows a dash and three hyphens (_ - - -). This is the overweight indication.



NOTE

The scanner/scale may blank (show an underscore and three hyphens) at any weight greater than its upper limit, but must blank when the upper limit plus 0.82 kilograms are set upon the weighing surface.

Decreasing-Load Test

This test ensures that the scanner/scale responds properly when a heavy object is followed by a significantly smaller object.

1. Place weights that total 15.8 kilograms.



NOTE

If the upper weight limit for your scale is not set at 15 kilograms, begin by placing weight equaling your upper limit setting plus 0.8 kilograms.

2. Remove weights to leave 10 kilograms on the scale and verify that the display shows between 9.990 and 10.010 kilograms.
3. Remove an additional 9.00 kilograms from the scale and check that the scale reads 1.000 kg.
4. You have completed the Decreasing Load Test.

Return to Zero Test

This test ensures that, after all other tests have been completed successfully, the scanner/scale returns to zero. Without any weight on the weigh platter, verify that the scale reads 0.000 kg.

You have completed the calibration and verification process for weighing in kilograms.

If the scanner/scale passes all these tests,

1. Remove the weigh platter, install the calibration switch cover and install a seal (if required).
2. Reinstall the weigh platter.

If the scanner/scale fails any of these tests, it should be serviced by a qualified technician.

NOTES

Section 6

Programming

Introduction to Label Programming

The programming bar code labels contained in this manual will allow you to customize and configure features and settings for your scanner (scanner/scale). To ensure full compatibility and proper function, use only the programming bar codes in this manual and other product-specific publications to program scanner features.

This manual has been developed to make it quick and easy for users of all levels to find the information needed to understand and configure features. The following descriptions will help you to determine where to go from here.

Understanding the Basics

If you have little or no prior experience with programming using bar code labels, you should review the first few pages of this section to familiarize yourself with the basics of scanner programming before performing any changes to your configuration.

Integrating the Scanner With Your Host System

Your scanner **MUST** be equipped with the correct hardware (interface board, cable, etc.) to properly communicate with your host system. Contact your dealer for information if you have questions about your scanner's hardware compatibility.

You may also want to contact the dealer or your system administrator if you have no record of how your scanner was pre-programmed at the factory. Scanners are typically programmed with the default settings for specific interface types (see *Appendix E, Factory Defaults* for more information); however, your scanner may have been custom configured with settings that are unique to your company or application.

Once you know the scanner's current settings, you can determine what changes will be required to allow communication with your host system and/or optional features you choose to modify to customize your installation. After recording the modifications needed, finish reading this section, then turn to the appropriate page and follow the instructions to program the scanner.

When all scanner features are programmed to your satisfaction, the scanner is ready to be placed into operation.

Customizing Your Scanner's Operation

Most scanner programming falls within three general categories:

- General Scanner and Scale Features - are features common to all interface types. Examples include beeper adjustments such as volume and length, read verification settings, etc.
- Interface Related Features - are the mandatory settings necessary to allow communication with your host terminal. Examples of these settings are: RS-232 baud rate and parity.



CAUTION

It is possible, via programming bar codes, to change the interface type (for example: from RS-232 to IBM Port 17). Great care should be taken to select the correct interface type, since you can cause damage to the scanner and/or POS terminal by attempting to change to an incompatible interface. ALWAYS make interface selections with the host cable DISCONNECTED.



NOTE

Ensure that your planned modifications are compatible with the current interface. For example, baud rate selections are only valid in the RS-232 interface. The scanner will sound an error tone when scanning programming labels for features invalid to the current interface group.

- Symbology Programming - gives the scanner the capability to autodiscriminate as few as one, and as many as all available symbologies. For optimal scanner performance enable only those symbologies required. Additionally the scanner may be programmed with the standard options available for the various symbologies, such as check digit, minimum label length, fixed and variable length bar codes, etc.

If you experience difficulties, have questions or require additional information, contact your local distributor, or call your dealer or sales representative.

Programming Overview

The scanner's programmable feature settings can be modified to accommodate your system's unique requirements. These settings can be communicated to the scanner in one of two ways:

1. Commands can be sent directly from the host. A limited set of host commands are available. Refer to *Appendix D* for more details or contact Tech Support.
2. Programming bar code labels can also be used to modify the scanner's programmable settings. This manual provides the bar code labels and instructions necessary to configure the scanner's features and options.



NOTE

When you program the scanner using any of the methods above, the scanner will store the changes until reprogrammed or returned to factory defaults.

Programming via Handheld Device

The scanner can also accept programming via its auxiliary port using a handheld scanning device. Eligible handheld devices must have the ability to transmit Code 128 function codes such as the programming bar codes presented in this manual. Datalogic models QuickScan[®] 1000 and QuickScan[®] 6000 support this functionality. Handheld data format requirements (baud rate, parity, etc.) are presented in *Appendix F* of this manual. Additionally the programmable feature, *Aux Port Mode*, must be set to “External Handheld Input” to allow operation.

What Is Programming Mode?

Programming Mode is a state in which the scanner must be placed in order to accept commands via programming bar code labels. When programming using the bar code labels in this manual, the scanner is typically placed in Programming Mode by scanning the SWITCH label.

While in the Programming Mode, the scanner only recognizes the special programming bar codes contained in this programming guide. See *Appendix A* for information about scanner indications while in the Programming Mode.

Entering and Exiting Programming Mode.

Use the bar code label below to enter and exit ('switch' into and out of) Programming Mode.

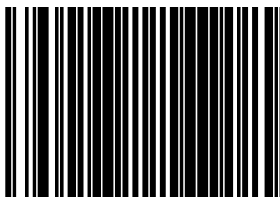

SWITCH LABEL

Programming Session

A typical programming session is conducted as follows:

1. Scan the SWITCH bar code to place the scanner in Programming Mode. Depending upon its current programming, the scanner may emit a beep or beeps, indicating it has read the bar code and the green LED will flash on and off slowly while the scanner remains in Programming Mode. Normal scanning functions are disabled.
2. Scan the programming bar code(s) that is (are) specially encoded to make the desired changes. With few exceptions¹, the scanner will emit a triple beep each time you scan a valid programming bar code.



NOTE

Not all features are available for all interfaces and the scanner will sound an error tone when scanning programming bar codes for features invalid to the current interface. Only features supported by the currently active interface will be implemented.



NOTE

If a bar code is scanned that changes the scanner's interface, all previous configuration items scanned in the programming session are lost.

Additionally, when programming a feature requiring you to scan single digits to set a multi-digit number, such as Minimum Label Length, scanning the SWITCH bar code (or any item tag/item value bar code) before completing all input will result in an error tone and cause the scanner to exit Programming Mode. Under these circumstances, the current feature you were trying to set is thrown out; any previous bar codes scanned during the session will take effect.

1. Some features, such as Minimum Label Length, require you to select the label's length by scanning a series of single-digit bar codes. A single 'good read' beep is sounded when scanning these single digits in Programming Mode. Only the final required digit in the sequence will produce a triple beep when scanned, indicating a successfully programmed feature.



NOTE

It is recommended that programming sessions be limited to one feature at a time. Should you make a mistake in the programming sequence, it can be difficult to discover where an error has been made if several features are programmed at once. Additionally, it can be confusing to determine which features may or may not have been successfully set following such a session.

3. Scan the SWITCH bar code to save any new settings and exit Programming Mode. The scanner will sound a beep and reset upon exiting Programming Mode, and the green LED will return to its usual state (on steady or off).

The scanner will exit Programming Mode under the following conditions:

- the programming sequence has been completed or the SWITCH bar code is scanned
 - five minutes have passed without scanning activity. Any data programmed during the current session will be ignored¹, and the scanner will reset and revert to its condition previous to initiating the exited session.
 - power is disconnected. Disconnecting power during Programming Mode, before scanning the SWITCH bar code, will cause all new settings to be ignored. On power-up, the scanner will return to previous settings.
4. Maintain a good record of all changes made to ensure that you know if the original factory settings have been changed.

1. Exception: If an interface bar code had been read while in Programming Mode, the scanner will operate on the default settings for the new interface.

Programming Sequence

To modify a scanner feature (item), the programming bar codes contained in this manual must be scanned in a given sequence depending upon the feature being programmed (as shown in Table 6-1). There are three possible programming sequences:



NOTE

If the scanner's interface type must be changed, always be sure that interface configuration is the FIRST item scanned during a programming session. (Selecting an interface type resets ALL other configuration items to the factory default for that interface type.)

- A. Programming sample A (the most commonly used format) demonstrates how three bar codes are scanned in sequence to do the following:
 1. Place the scanner in Programming Mode (SWITCH bar code).
 2. Scan the Item Tag¹ that will enable the new feature.
 3. End the programming session and reset the scanner (SWITCH bar code).
- B. Sample B provides an example of a programming feature requiring the entry of a range value. Like sample A, the scanner is placed in Programming Mode and an Item Tag¹ is scanned. Then, a value must be entered before ending the programming session. In the example, three digits must be scanned from the number pad in *Appendix C*. This type of format, requiring several bar codes, is necessary to allow flexible programming for item values with larger numeric ranges.
- C. The programming sequence shown in example C requires scanning of a single, extended length bar code. This special programming bar code contains all the data necessary to enter Programming Mode, set the Item Tag¹ and Item Value, and exit Programming Mode (all in one step).

1. An "Item Tag" is a term used to describe an assigned number, which is encoded in a programming bar code, that toggles (selects, enables, disables, etc.) a specific programming feature.

Table 6-1. Programming Sequence

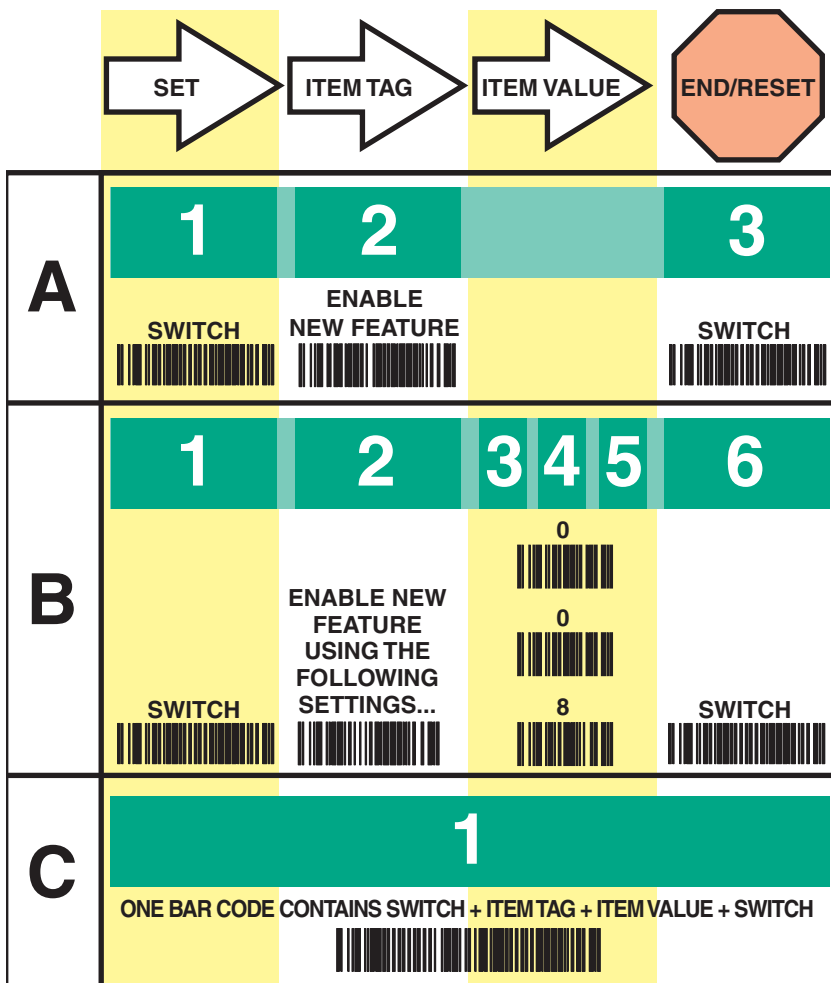

LED and Beeper Indicators

The scanner provides a set of indicators that verify/announce the various scanner functions.

If You Make a Mistake...

If, during a programming session, you find that you are unsure of the scanner's settings or wish to reset the scanner's configuration, use the Return to Factory Settings label below to return the scanner's configuration to the factory settings. Scanning this label will also reset any changes made during previous programming sessions.

Return to Factory Settings

Scan this bar code to return the scanner to the default settings configured at the factory for the currently active interface. This bar code is typically used to return the scanner to a "known" operating state when the present programming status is not known, faulty, or suspect.



CAUTION

Use this bar code with caution, since it will reset ALL features that may have been programmed since the scanner's installation.



NOTE

DO NOT scan the SWITCH bar code before and after scanning this bar code.

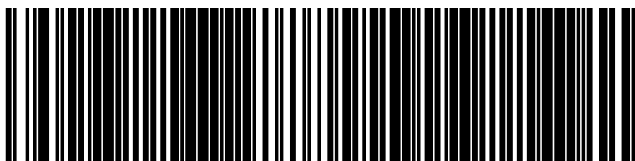

RETURN TO FACTORY SETTINGS

Test Mode

Use this feature to place the scanner into a testing, or “demo” mode. This special mode disables the scanner interface, meaning that bar code data is not sent out to the host via the scanner interface. This allows the bar code to be scanned continuously without requiring a response from the POS terminal.

To return the scanner to normal function, scan the *TEST MODE = DISABLE* bar code below.



NOTE

DO NOT scan the SWITCH bar code before and after scanning the bar codes on this page.

Scanning the *TEST MODE = DISABLE* bar code sets the Double Read Timeout to 600ms.



TEST MODE = DISABLE



TEST MODE = ENABLE

General Scanner and Scale Features

Double Read Timeout

The Double Read Timeout feature sets a time limit that determines how much time must pass before reading the same label again (e.g. two identical items in succession).

To set the Double Read Timeout:

1. Scan the SWITCH bar code.
2. Scan your selection from the bar codes below. You'll need to cover any unused bar codes on this and the facing page to ensure that the scanner reads only the bar code you intend to scan.
3. Complete the programming sequence by scanning the SWITCH bar code.



NOTE

If the incidence of multiple reads is not acceptable, increase the Double Read Timeout setting to a higher value.



DOUBLE READ TIMEOUT = 400ms



DOUBLE READ TIMEOUT = 600ms

Double Read Timeout — continued

Remember to cover any unused bar codes on this and the facing page to ensure that the scanner reads only the bar code you intend to scan.



DOUBLE READ TIMEOUT = 800ms



DOUBLE READ TIMEOUT = 1 SECOND

Laser Timeout

The laser timeout feature sets the time for switching the visible laser diodes (VLDs) off if the scanner is idle. Using this feature can prolong the life of the VLDs.

To set the Laser Timeout:

1. Scan the SWITCH bar code.
2. Scan your selection from the bar codes below. You'll need to cover any unused bar codes on this and the facing page to ensure that the scanner reads only the bar code you intend to scan.
3. Complete the programming sequence by scanning the SWITCH bar code.



LASER TIMEOUT = 5 MINUTES

Laser Timeout — continued

Remember to cover any unused bar codes on this and the facing page to ensure that the scanner reads only the bar code you intend to scan.



LASER TIMEOUT = 10 MINUTES



LASER TIMEOUT = 15 MINUTES

Motor Timeout

The Motor Timeout feature sets the time for automatically switching the motor off when the scanner is not in use.



NOTE

Laser safety requires that the laser switch off before the motor. If you set the motor timeout shorter than the laser timeout, the motor and the laser will both shut off when the motor timeout expires.

To set the Motor Timeout:

1. Scan the SWITCH bar code.
2. Scan your selection from the bar codes below. You'll need to cover any unused bar codes on this and the facing page to ensure that the scanner reads only the bar code you intend to scan.
3. Complete the programming sequence by scanning the SWITCH bar code.



MOTOR TIMEOUT = 5 MINUTES

Motor Timeout — continued

Remember to cover any unused bar codes on this and the facing page to ensure that the scanner reads only the bar code you intend to scan.



MOTOR TIMEOUT = 10 MINUTES



MOTOR TIMEOUT = 15 MINUTES

Motor Timeout — continued

Remember to cover any unused bar codes on this and the facing page to ensure that the scanner reads only the bar code you intend to scan.

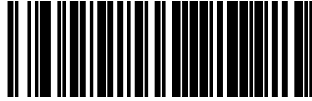

MOTOR TIMEOUT = 30 MINUTES



MOTOR TIMEOUT = 60 MINUTES

Green LED Idle State

This feature specifies the state of the green scanner LED when the scanner is idle and ready to read a label. Options are:

- Off
- On dim

To set the LED Idle State:

1. Scan the SWITCH bar code.
2. Scan your selection from the bar codes below. You'll need to cover any unused bar codes on this and the facing page to ensure that the scanner reads only the bar code you intend to scan.
3. Complete the programming sequence by scanning the SWITCH bar code.



GREEN LED IDLE STATE = OFF



GREEN LED IDLE STATE = ON DIM

Scanner Button Options

Configure the scanner volume button to one of the following modes of operation:

- Enable all functions: Volume, tone, diagnostics and reset.
- Enable only volume, tone and reset.
- Enable reset only.
- Disable all button functions

To set the desired Scanner Button Option:

1. Scan the SWITCH bar code.
2. Scan your selection from the bar codes below. You'll need to cover any unused bar codes on this and the facing page to ensure that the scanner reads only the bar code you intend to scan.
3. Complete the programming sequence by scanning the SWITCH bar code.

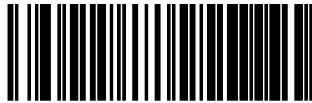

SCANNER BUTTON OPTION = ENABLE ALL FUNCTIONS

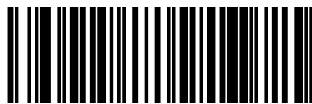

SCANNER BUTTON OPTION = ENABLE ONLY VOLUME/TONE/RESET

Scanner Button Options — continued

Remember to cover any unused bar codes on this and the facing page to ensure that the scanner reads only the bar code you intend to scan.



SCANNER BUTTON OPTION = ENABLE RESET ONLY



SCANNER BUTTON OPTION = DISABLE ALL BUTTON FUNCTIONS

Power-up Beep Control

Specifies the type of audible indication that is made when entering scanner-active mode on power-up. Choices are:

- No beep
- One beep
- Three beeps

To set the Power-up Beep:

1. Scan the SWITCH bar code.
2. Scan your selection from the three bar codes below. You'll need to cover any unused bar codes on this and the facing page to ensure that the scanner reads only the bar code you intend to scan.
3. Complete the programming sequence by scanning the SWITCH bar code.



POWER-UP BEEP = OFF

Power-up Beep Control — continued

Remember to cover any unused bar codes on this and the facing page to ensure that the scanner reads only the bar code you intend to scan.



POWER-UP BEEP = ONE BEEP



POWER-UP BEEP = THREE BEEPS

Good Read Beep Control

This feature enables/disables scanner beep upon successfully decoding of a label.

To set this feature:

1. Scan the SWITCH bar code.
2. Scan your selection from the two bar codes below. You'll need to cover any unused bar codes on this and the facing page to ensure that the scanner reads only the bar code you intend to scan.
3. Complete the programming sequence by scanning the SWITCH bar code.



GOOD READ BEEP = DISABLE



GOOD READ BEEP = ENABLE

Good Read Beep Frequency

Adjusts the scanner's good read beep to sound at low, medium, or high frequency (controls the beeper's pitch/tone).

- Low = 660 Hz
- Medium = 860 Hz
- High = 1050 Hz

To set the Good Read Beep Frequency:

1. Scan the SWITCH bar code.
2. Scan your selection from the three bar codes below. You'll need to cover any unused bar codes on this and the facing page to ensure that the scanner reads only the bar code you intend to scan.
3. Complete the programming sequence by scanning the SWITCH bar code.



GOOD READ BEEP FREQUENCY = LOW

Good Read Beep Frequency — continued

Remember to cover any unused bar codes on this and the facing page to ensure that the scanner reads only the bar code you intend to scan.

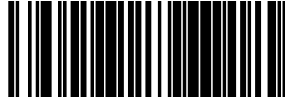

GOOD READ BEEP FREQUENCY = MEDIUM

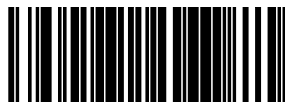

GOOD READ BEEP FREQUENCY = HIGH

Good Read Beep Length

Specifies the duration of a good read beep.

To set the good read beep length:

1. Scan the SWITCH bar code.
2. Scan the bar code, *SET GOOD READ BEEP LENGTH*. You'll need to cover any unused bar codes on this and the facing page to ensure that the scanner reads only the bar code you intend to scan.
3. Scan the appropriate digits from the keypad in *Appendix C* that represent the desired good read beep length setting. The selectable range is 1-255, which is the timeout in 10-millisecond increments. Pad all single and double digit numbers with leading zeroes to yield a three-digit entry (001-255).

Examples:

001 = 10ms

005 = 50ms

040 = 400ms

250 = 2,500ms (2.5 seconds)

4. The scanner will automatically exit Programming Mode when the appropriate amount of digits have been scanned

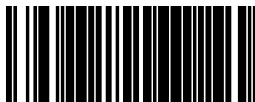

SET GOOD READ BEEP LENGTH

Good Read Beep Volume

Selects the beeper volume upon a good read beep. There are five selectable volumes, with each volume increment adding approximately five decibels to the previous level:

- 0 = Lowest Volume
- 1 = Medium-Low Volume
- 2 = Medium Volume
- 3 = Medium-High Volume
- 4 = Highest Volume

To set the Good Read Beep Volume:

1. Scan the SWITCH bar code.
2. Scan your selected volume bar code from this or the following pages. You'll need to cover any unused bar codes on this and the facing page to ensure that the scanner reads only the bar code you intend to scan.
3. Complete the programming sequence by scanning the SWITCH bar code.



GOOD READ BEEP VOLUME = LOWEST

Good Read Beep Volume — continued

Remember to cover any unused bar codes on this and the facing page to ensure that the scanner reads only the bar code you intend to scan.

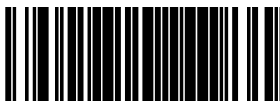

GOOD READ BEEP VOLUME = MEDIUM LOW



GOOD READ BEEP VOLUME = MEDIUM

Good Read Beep Volume — continued

Remember to cover any unused bar codes on this and the facing page to ensure that the scanner reads only the bar code you intend to scan.

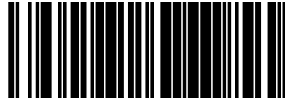

GOOD READ BEEP VOLUME = MEDIUM HIGH

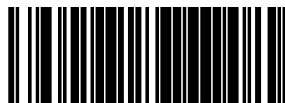

GOOD READ BEEP VOLUME = HIGHEST

Good Read When to Indicate

This feature specifies when the scanner will provide indication (beep and/or flash its green LED) upon successfully reading a bar code.

- Good Read = Indicate after decode
- Good Read = Indicate after transmit
- Good Read = Indicate after CTS goes inactive, then active



NOTE

The “Indicate after CTS goes inactive...” mode applies to RS-232 STD and RS-232 WN interfaces only. If set to this mode in other interfaces, “Indicate after decode” mode will be implemented.

To set the Good Read When to Indicate feature:

1. Scan the SWITCH bar code.
2. Scan the desired mode bar code from this page. You’ll need to cover any unused bar codes on this and the facing page to ensure that the scanner reads only the bar code you intend to scan.
3. Complete the programming sequence by scanning the SWITCH bar code.

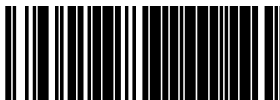

GOOD READ = INDICATE AFTER DECODE

Good Read When to Indicate — continued

Remember to cover any unused bar codes on this and the facing page to ensure that the scanner reads only the bar code you intend to scan.

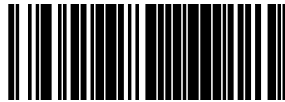

GOOD READ = INDICATE AFTER TRANSMIT



GOOD READ = INDICATE AFTER CTS GOES INACTIVE, THEN ACTIVE
(RS-232 ONLY)

Scale Enable

Use this feature to enable or disable scale operation.

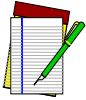

NOTE

Recalibration/recertification may be required when adding scale functionality. Consult your local Weights and Measures authority.

If this feature is enabled the scanner will expect that it is to function as a scanner-scale, and will indicate an error if it is not a scale-equipped unit. See *Error Codes* in Section 4 for more information.

To set this feature:

1. Scan the SWITCH bar code.
2. Scan your selection from the two bar codes below. You'll need to cover any unused bar codes on this and the facing page to ensure that the scanner reads only the bar code you intend to scan.
3. Complete the programming sequence by scanning the SWITCH bar code.

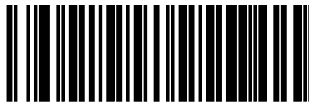

SCALE = DISABLE

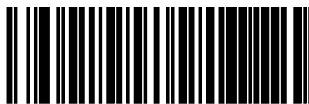

SCALE = ENABLE

Scale Country Mode

When a weight is presented, the scanner/scale will apply the country-specific weighing rules specified via this feature.

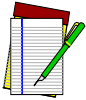

NOTE

Scale Country Mode applies only when a scale is enabled.

RS-232 SASI scale interface supports only U.S.A. mode.

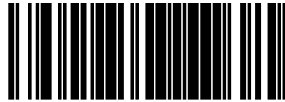

SCALE COUNTRY MODE = U.S.A.



SCALE COUNTRY MODE = U.K.

Scale Country Mode — continued

Remember to cover any unused bar codes on this and the facing page to ensure that the scanner reads only the bar code you intend to scan.

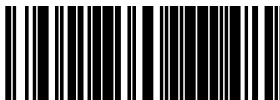

SCALE COUNTRY MODE = AUSTRALIA

Scale Enforced Zero Return

This feature enables/disables the enforced zero return of the scale. Three settings are available for this feature:

- Disable
- Scale Must Return to Zero Weight Within Four Minutes — Scale will require re-zeroing if a non-zero weight is left on for more than 4 minutes
- Scale Must Return to Zero Weight Between Weight Requests — Re-zeroing required if weight doesn't return to zero between weight requests from the POS, plus scale will require re-zeroing if a non-zero weight is left on for more than 4 minutes.

To set this feature:

1. Scan the SWITCH bar code.
2. Scan your selection from the bar codes below. You'll need to cover any unused bar codes on this and the facing page to ensure that the scanner reads only the bar code you intend to scan. The strategy is to select the lowest possible filter level needed that allows normal scale operation.
3. Complete the programming sequence by scanning the SWITCH bar code.



SCALE ENFORCED ZERO RETURN = DISABLE

Scale Enforced Zero Return — continued

Remember to cover any unused bar codes on this and the facing page to ensure that the scanner reads only the bar code you intend to scan.

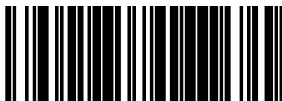

SCALE ENFORCED ZERO RETURN = SCALE MUST RETURN TO ZERO WEIGHT
WITHIN 4 MINUTES



SCALE ENFORCED ZERO RETURN = SCALE MUST RETURN TO ZERO WEIGHT
BETWEEN WEIGHT REQUESTS

Scale Interface Type

Use this feature to select the scale interface type. Choices are:

- No Scale Interface
- RS-232 — SASI
- RS-232 — ICL

To set the Scale Interface Type:

1. Scan the SWITCH bar code.
2. Scan your selection from the bar codes below. You'll need to cover any unused bar codes on this and the facing page to ensure that the scanner reads only the bar code you intend to scan.
3. Complete the programming sequence by scanning the SWITCH bar code.

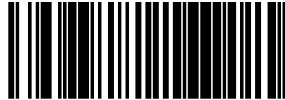

SCALE INTERFACE TYPE = NO SCALE INTERFACE



SCALE INTERFACE TYPE = RS-232 — SASI

Scale Interface Type — continued

Remember to cover any unused bar codes on this and the facing page to ensure that the scanner reads only the bar code you intend to scan.



SCALE INTERFACE TYPE = RS-232 — ICL

Scale Motion Level Filter

In environments where checkstands generate excessive vibration, the scale can be set to filter a certain amount of the motion with regard to its operation.



NOTE

This filter is generally used only in applications where scale error E_1 (too much motion at power-up) has occurred.

To set this feature:

1. Scan the SWITCH bar code.
2. Scan your selection from the bar codes below. You'll need to cover any unused bar codes on this and the facing page to ensure that the scanner reads only the bar code you intend to scan. The strategy is to select the lowest possible filter level needed that allows normal scale operation.
3. Complete the programming sequence by scanning the SWITCH bar code.



SCALE MOTION LEVEL FILTER = LOW



SCALE MOTION LEVEL FILTER = MEDIUM LOW

Scale Motion Level Filter — continued

Remember to cover any unused bar codes on this and the facing page to ensure that the scanner reads only the bar code you intend to scan.



SCALE MOTION LEVEL FILTER = MEDIUM HIGH



SCALE MOTION LEVEL FILTER = HIGH

Scale LED Enable

This feature enables/disables Scale LED (Yellow LED) operation.

To set this feature:

1. Scan the SWITCH bar code.
2. Scan your selection from the two bar codes below. You'll need to cover any unused bar codes on this and the facing page to ensure that the scanner reads only the bar code you intend to scan.
3. Complete the programming sequence by scanning the SWITCH bar code.

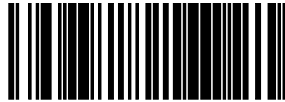

SCALE LED = DISABLE



SCALE LED = ENABLE

Remote Display — Enable/Disable

The scanner-scale can be configured to operate with or without a Remote Display.

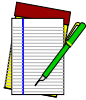

NOTE

Recalibration/recertification may be required when adding a Remote Display. Consult your local Weights and Measures authority.

If this feature is enabled the scanner-scale will expect that it is connected to a Remote Display, and will indicate an error if one is not. See *Error Codes* in Section 4 for more information.



REMOTE DISPLAY = DISABLE



REMOTE DISPLAY = ENABLE

EAS Active State

Specifies the active state polarity of EAS (Electronic Article Surveillance); the inactive state is its opposite polarity. EAS output goes active during the good read of a bar code, allowing the EAS device to deactivate a tag on the product.

To set the EAS Active State:

1. Scan the SWITCH bar code.
2. Scan bar code below representing the desired setting. You'll need to cover any unused bar codes on this and the facing page to ensure that the scanner reads only the bar code you intend to scan.
3. Complete the programming sequence by scanning the SWITCH bar code.

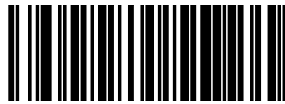

EAS ACTIVE STATE = ACTIVE LOW



EAS ACTIVE STATE = ACTIVE HIGH

EAS Timeout

Specifies the amount of time that an EAS (Electronic Article Surveillance) signal is held in its active state for a good read.

To set the EAS Timeout:

1. Scan the SWITCH bar code.
2. Scan the bar code, SET EAS TIMEOUT below. You'll need to cover any unused bar codes on this and the facing page to ensure that the scanner reads only the bar code you intend to scan.
3. Scan the appropriate digits from the keypad in *Appendix C* that represent the desired EAS Timeout duration. The selectable range is 0-255, which is the timeout in 10-millisecond increments. Pad all single and double digit numbers with leading zeroes to yield a three-digit entry (000-255).

Examples:

000 = EAS timeout disabled

001 = 10ms

005 = 50ms

040 = 400ms

250 = 2,500ms (2.5 seconds)



NOTE

A setting of 0 (000) disables this feature.

4. The scanner will automatically exit Programming Mode when the appropriate amount of digits have been scanned



SET EAS TIMEOUT

Aux Port Mode

Selects the usage for the scanner's optional auxilliary port. The choices listed below are mutually exclusive (only one option can be active at a time).

- Disabled — Port is inactive
- External Handheld Input — Supports Datalogic handheld scanners (QuickScan 1000, QuickScan 6000, PowerScan) as well as other models such as the Symbol® HotShot. Call your dealer for more information about supported devices.



NOTE

Cable pinout information for the Aux Port is provided in **Appendix B** of this manual. A connected handheld scanner must be configured to transmit data as outlined in **Appendix F**.

- PIR — PIR (Productivity Index Reporting) allows the scanner to provide information to an external computer indicating how easy the label was to read.

To set this feature:

1. Scan the SWITCH bar code.
2. Scan your selection from the bar codes below. You'll need to cover any unused bar codes on this and the facing page to ensure that the scanner reads only the bar code you intend to scan.
3. Complete the programming sequence by scanning the SWITCH bar code.



AUX PORT MODE = DISABLE

Aux Port Mode — continued

Remember to cover any unused bar codes on this and the facing page to ensure that the scanner reads only the bar code you intend to scan.



AUX PORT MODE = EXTERNAL HANDHELD INPUT



AUX PORT MODE = PIR

Productivity Index Reporting (PIR)

When PIR is enabled, label quality data is appended to decoded data before being presented to the POS. The PIR feature allows the scanner to provide information to an external computer indicating how easy the label was to read.



NOTE

This value-added feature is a factory-programmed option. Contact your dealer for information about upgrading your system to include this advanced capability.

To set this feature:

1. Scan the SWITCH bar code.
2. Scan your selection from the bar codes below. You'll need to cover any unused bar codes on this and the facing page to ensure that the scanner reads only the bar code you intend to scan.
3. Complete the programming sequence by scanning the SWITCH bar code.



PIR = DISABLE



PIR = ENABLE

Interface Related Features

Interface Type



NOTE

The 8100 scanner family supports only a single interface type defined at the factory. 8100 scanners that support either IBM USB or IBM Port 17 cannot have their interface type changed, and will reject programming bar codes that attempt to change it. 8100 scanners that support one of the RS-232 interface types can be changed to another RS-232 type, but cannot be changed to IBM USB or IBM Port 17.

Specifies the current scanner interface. Selections are:

INTERFACE TYPE	INTERFACE IDENTIFICATION NUMBER ^a
RS-232 Standard	05
RS-232 Wincor-Nixdorf	12
RS-232 Single Cable	20
IBM USB	45
IBM Port 17	04
NOT USER-SELECTABLE	
Null Interface	Indicated by 7-segment FRU display flashing 0 at start-up

- a. To access a scanner's interface identification number, place the scanner in Scanner Diagnostic Mode and view the 7-segment FRU display (reference *Scanner Diagnostic Mode* in Section 2 for more information).



NOTE

A new scanner may have been shipped from the factory with a Null Interface (no interface type selected) to ensure system compatibility at installation. In this case, the correct Interface Type programming bar code must be scanned first before the scanner can be used with a POS system.

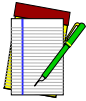

NOTE

If the scanner's interface type must be changed, always be sure that interface configuration is the **FIRST** item scanned during a programming session. (Selecting an interface type resets **ALL** other configuration items to the factory default for that interface type.)

Interface Type — continued

To select the desired interface:



CAUTION

Great care should be taken to select the correct interface type, since you can cause damage to the scanner and/or POS terminal by attempting to change to an incompatible interface. **ALWAYS** make interface selections with the host cable **DISCONNECTED**.

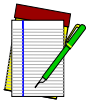

NOTE

When an interface is selected, the scanner loads the factory configuration for that interface as the selection is made, erasing any and all custom configuration that may have previously been done.

1. Disconnect current interface cable(s) if currently connected.
2. Scan the SWITCH bar code
3. Scan the bar code representing the appropriate interface located on the following pages. You'll need to cover any unused bar codes adjacent to and on any facing pages to ensure the scanner reads only the bar code you intend to scan.
4. Complete the programming sequence by scanning the SWITCH bar code.



NOTE

Once the correct interface has been set, it will be necessary to proceed to the appropriate pages in this manual that select parameters and options for that interface. For example, if RS-232 is selected, turn to the pages in this manual headed as features specific to the RS-232 interface.

5. Connect new interface cable(s).

RS-232 Interface Selection

Remember to cover any unused bar codes on this and the facing page to ensure that the scanner reads only the bar code you intend to scan.



CAUTION

Great care should be taken to select the correct interface type, since you can cause damage to the scanner and/or POS terminal by attempting to change to an incompatible interface. **ALWAYS** make interface selections with the host cable **DISCONNECTED**.



INTERFACE TYPE = RS-232 STANDARD

RS-232 Wincor-Nixdorf Interface Selection

Remember to cover any unused bar codes on this and the facing page to ensure that the scanner reads only the bar code you intend to scan.



Great care should be taken to select the correct interface type, since you can cause damage to the scanner and/or POS terminal by attempting to change to an incompatible interface. **ALWAYS** make interface selections with the host cable **DISCONNECTED**.



INTERFACE TYPE = RS-232 WINCOR-NIXDORF

RS-232 Single Cable Interface Selection

Remember to cover any unused bar codes on this and the facing page to ensure that the scanner reads only the bar code you intend to scan.



CAUTION

Great care should be taken to select the correct interface type, since you can cause damage to the scanner and/or POS terminal by attempting to change to an incompatible interface. **ALWAYS** make interface selections with the host cable **DISCONNECTED**.



NOTE

Single cable installations require connection at the POS Terminal (host) port. The Scale Host port connection is not used for this interface.



INTERFACE TYPE = RS-232 SINGLE CABLE

IBM Port 17 Interface Selection

Remember to cover any unused bar codes on this and the facing page to ensure that the scanner reads only the bar code you intend to scan.



Great care should be taken to select the correct interface type, since you can cause damage to the scanner and/or POS terminal by attempting to change to an incompatible interface. **ALWAYS** make interface selections with the host cable **DISCONNECTED**.

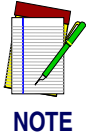

Single cable installations require connection at the POS Terminal (host) port. The Scale Host port connection is not used for this interface.



INTERFACE TYPE = IBM PORT 17

IBM USB Interface Selection

Remember to cover any unused bar codes on this and the facing page to ensure that the scanner reads only the bar code you intend to scan.



Great care should be taken to select the correct interface type, since you can cause damage to the scanner and/or POS terminal by attempting to change to an incompatible interface. **ALWAYS** make interface selections with the host cable **DISCONNECTED**.



Single cable installations require connection at the POS Terminal (host) port. The Scale Host port connection is not used for this interface.



INTERFACE TYPE = IBM USB

Maximum Host-Transmitted Message Length

Specifies the maximum number of data characters allowed in messages transmitted to the host.

To set the Maximum Host-Transmitted Message Length:

1. Scan the SWITCH bar code.
2. Scan the bar code, *SET MAXIMUM HOST-TRANSMITTED MESSAGE LENGTH* below. You'll need to cover any unused bar codes on this and the facing page to ensure that the scanner reads only the bar code you intend to scan.
3. Scan the appropriate digits from the keypad in *Appendix C* that represent the desired maximum host-transmitted message length. The selectable range is 0-249 data characters. (Labels that are longer than this length are not read.) Pad all single and double digit numbers with leading zeroes to yield a three-digit entry (000-249).



NOTE

If this configuration item is set to 0 (000), there is no general length limit imposed on data being transmitted to the host.

4. The scanner will automatically exit Programming Mode when the appropriate amount of digits have been scanned



SET MAXIMUM HOST-TRANSMITTED MESSAGE LENGTH

Number of Host Transmission Buffers

Specifies the number of host transmission(s) that may be buffered. By buffering data from a bar code, the scanner can continue to read a new bar code while the old one is being transmitted to the host. Selecting BUFFERS = 1 means that the first bar code must be transmitted before a new one can be read. A selection of BUFFERS = 2 means that a new bar code can be read while data from the first bar code is transmitted. When the feature, *Good Read Beep Control*, is enabled, the scanner will beep when the data is placed in a transmission buffer.

When a DISABLE SCANNER command is received from the host, the scanner will continue to transmit all data that is buffered.

To select the Number of Host Transmission Buffers:

1. Scan the SWITCH bar code.
2. Scan bar code below representing the desired setting. You'll need to cover any unused bar codes on this and the facing page to ensure that the scanner reads only the bar code you intend to scan.
3. Complete the programming sequence by scanning the SWITCH bar code.

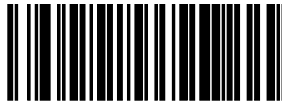

NUMBER OF HOST TRANSMISSION BUFFERS = 1



NUMBER OF HOST TRANSMISSION BUFFERS = 2

Global Prefix

This feature applies to RS-232 interfaces (Standard, Wincor-Nixdorf, and Single Cable). It specifies the prefix that is added to beginning of label transmission.

To specify the Global Prefix Character(s):

1. Scan the SWITCH bar code.
2. Scan the bar code, *SET GLOBAL PREFIX* below. You'll need to cover any unused bar codes to ensure the scanner reads only the bar code you intend to scan.
3. Scan the appropriate characters/digits from the keypad in *Appendix C* that represent the hex designation for the desired character(s). A table containing the *ASCII Character Set* and their corresponding Hex Values is available in the inside back cover of this manual. ASCII parameters must be input by scanning a pair of hexadecimal digits for each character. Thus, to set a two-character value of AB, bar codes containing the digits '4', '1', '4', and '2' must be scanned. The selectable range for this option is any hex value from 00 to FF. Up to 20 hex pairs can be designated.



NOTE

To specify "no Global Prefix," scan 00.

4. If designating the full 20 hex pairs, the scanner will automatically exit Programming Mode when the appropriate amount of digits have been scanned. If designating less than 20 hex pairs, you can end the programming sequence early by scanning the *TERMINATE SEQUENCE* bar code.
5. Complete the programming sequence by scanning the SWITCH bar code.

Global Prefix — continued

Remember to cover any unused bar codes on this and the facing page to ensure that the scanner reads only the bar code you intend to scan.



SET GLOBAL PREFIX

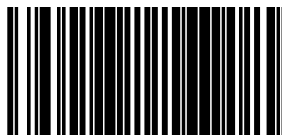

TERMINATE SEQUENCE

Global Suffix

This feature applies to RS-232 interfaces (Standard, Wincor-Nixdorf, and Single Cable). It specifies the suffix that is added to end of a label transmission. Three standard options are available below. Contact your dealer for other alternate settings for this feature.

- No Global Suffix
- CR — Carriage Return
- CR LF — Carriage Return, Line Feed

To set the Global Suffix:

1. Scan the SWITCH bar code.
2. Scan your selection from the bar codes below.
3. Complete the programming sequence by scanning the SWITCH bar code.



GLOBAL SUFFIX = NO GLOBAL SUFFIX

Global Suffix — continued

Remember to cover any unused bar codes on this and the facing page to ensure that the scanner reads only the bar code you intend to scan.



GLOBAL SUFFIX = CR



GLOBAL SUFFIX = CR LF

IBM Features

IBM Interface Options

IBM interfaces offer specific control over interaction with certain devices.



NOTE

The IBM USB interface provides its own set of options. Refer to the feature, IBM USB Interface Options, in this chapter.

Options for this feature are as follows:

- FULL host interface support — Accepts scanner and scale configuration host commands.
- Ignore host interface configuration of scanner and scale — Ignores all scanner and scale configuration host commands.

To set this feature:

1. Scan the SWITCH bar code.
2. Scan your selection from the bar codes below. You'll need to cover any unused bar codes on this and the facing page to ensure that the scanner reads only the bar code you intend to scan.
3. Complete the programming sequence by scanning the SWITCH bar code.



IBM INTERFACE OPTION = FULL HOST INTERFACE SUPPORT



IBM INTERFACE OPTION = IGNORE HOST I/F CONFIG OF SCANNER & SCALE

IBM Scale Address



This feature applies to IBM Port 17 ONLY.

NOTE

Specifies IBM scale address for IBM Port 17. The following three addresses are available:

- 6A
- 6B
- 6E

To set the IBM Scale Address:

1. Scan the SWITCH bar code.
2. Scan the bar code below or from the following page that represents the desired scale address designation.
3. Complete the programming sequence by scanning the SWITCH bar code.



IBM SCALE ADDRESS = 6A

IBM Scale Address — continued

Remember to cover any unused bar codes on this and the facing page to ensure that the scanner reads only the bar code you intend to scan.

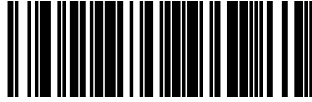

IBM SCALE ADDRESS = 6B

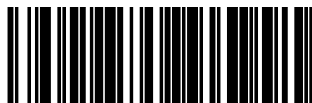

IBM SCALE ADDRESS = 6E

IBM Transmit Labels in Code 39 Format

This feature enables/disables scanner's ability to set a symbology identifier for a specified label to Code 39 before transmitting that label data to an IBM host. This applies to: Code 128, Code 93 and Codabar for IBM Port 5B; Code 93 and Codabar for IBM Port 9B; Code 128, Code 93 and Codabar for IBM-USB.



When enabled, this feature has no effect on IBM Port 17.

NOTE

To enable/disable the IBM Transmit Labels in Code 39 Format feature:

1. Scan the SWITCH bar code.
2. Scan either the enable or disable bar code below. You'll need to cover any unused bar codes on this and the facing page to ensure that the scanner reads only the bar code you intend to scan.
3. Complete the programming sequence by scanning the SWITCH bar code.

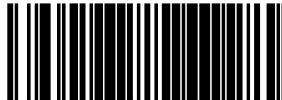

IBM TRANSMIT LABELS IN CODE 39 FORMAT = DISABLE



IBM TRANSMIT LABELS IN CODE 39 FORMAT = ENABLE

IBM USB Interface Options

The IBM-USB interface offers specific control over interaction with certain devices. Options for this feature are as follows:

- FULL host interface support — Accepts scanner and scale configuration host commands.
- Compatible with Magellan SL host interface support — Uses Magellan SL host interface support.
- Ignore host interface configuration of scanner and scale — Ignores all scanner and scale configuration host commands.



NOTE

This feature applies only to the IBM USB interface. For other IBM interfaces, refer to the feature, IBM Interface Options, earlier in this chapter.

To set this feature:

1. Scan the SWITCH bar code.
2. Scan your selection from the bar codes below. You'll need to cover any unused bar codes on this and the facing page to ensure that the scanner reads only the bar code you intend to scan.
3. Complete the programming sequence by scanning the SWITCH bar code.



IBM USB INTERFACE OPTION = FULL HOST INTERFACE SUPPORT

IBM USB Interface Options — continued

Remember to cover any unused bar codes on this and the facing page to ensure that the scanner reads only the bar code you intend to scan.



IBM USB INTERFACE OPTION = COMPATIBLE W/MAGELLAN SL HOST I/F SUP-
PORT



IBM USB INTERFACE OPTION = IGNORE HOST I/F CONFIG OF SCANNER &
SCALE

IBM USB Scanner Device Type

The IBM-USB protocol allows for the scanner to be identified as one of two different types of barcode scanners. Depending on what other scanners you may already have connected to a USB POS, you may need to change this setting to enable all scanners to communicate. Options are:

- Table Top Scanner
- Handheld Scanner

To set this feature:

1. Scan the SWITCH bar code.
2. Scan your selection from the bar codes below. You'll need to cover any unused bar codes on this and the facing page to ensure that the scanner reads only the bar code you intend to scan.
3. Complete the programming sequence by scanning the SWITCH bar code.



IBM USB SCANNER DEVICE TYPE = TABLE TOP SCANNER



IBM USB SCANNER DEVICE TYPE = HANDHELD SCANNER

RS-232 Features

RS-232 Baud Rate

This feature selects the baud rate required for sending and receiving data.



NOTE

Single cable interfaces are limited to Baud Rate selections up to 19200. They cannot communicate at Baud Rates of 38400 and up.

To specify the RS-232 Baud Rate:

1. Scan the SWITCH bar code.
2. Scan the desired baud rate from the bar codes below and on the immediately following pages. You'll need to cover any unused bar codes on this and the facing page to ensure that the scanner reads only the bar code you intend to scan.
3. Complete the programming sequence by scanning the SWITCH bar code.

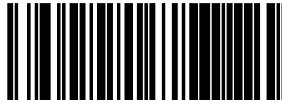

RS-232 BAUD RATE = 1200



RS-232 BAUD RATE = 2400

RS-232 Baud Rate — continued

Remember to cover any unused bar codes on this and the facing page to ensure that the scanner reads only the bar code you intend to scan.



RS-232 BAUD RATE = 4800



RS-232 BAUD RATE = 9600

RS-232 Baud Rate — continued

Remember to cover any unused bar codes on this and the facing page to ensure that the scanner reads only the bar code you intend to scan.



RS-232 BAUD RATE = 19200



RS-232 BAUD RATE = 38400

RS-232 Baud Rate — continued

Remember to cover any unused bar codes on this and the facing page to ensure that the scanner reads only the bar code you intend to scan.



RS-232 BAUD RATE = 57600



RS-232 BAUD RATE = 115200

RS-232 Number of Data Bits

Specifies number of data bits required for sending and receiving data.

To set this feature:

1. Scan the SWITCH bar code.
2. Scan the bar code below representing the desired Data Bit setting. You'll need to cover any unused bar codes on this and the facing page to ensure that the scanner reads only the bar code you intend to scan.
3. Complete the programming sequence by scanning the SWITCH bar code.

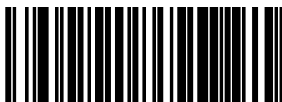

RS-232 NUMBER OF DATA BITS = 7



RS-232 NUMBER OF DATA BITS = 8

RS-232 Number of Stop Bits

Specifies number of stop bits required for sending and receiving data.

To set this feature:

1. Scan the SWITCH bar code.
2. Scan the bar code below representing the desired Stop Bit setting. You'll need to cover any unused bar codes on this and the facing page to ensure that the scanner reads only the bar code you intend to scan.
3. Complete the programming sequence by scanning the SWITCH bar code.

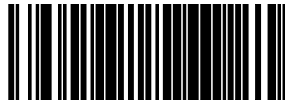

RS-232 NUMBER OF STOP BITS = 1

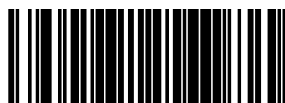

RS-232 NUMBER OF STOP BITS = 2

RS-232 Parity

Specifies parity required for sending and receiving data.

Options for this setting are:

- RS-232 PARITY = NONE
- RS-232 PARITY = EVEN
- RS-232 PARITY = ODD

To set this feature:

1. Scan the SWITCH bar code.
2. Scan the bar code below or on the following pages representing the desired Parity setting. You'll need to cover any unused bar codes, as well as facing pages to ensure that the scanner reads only the bar code you intend to scan.
3. Complete the programming sequence by scanning the SWITCH bar code.



RS-232 PARITY = NONE

RS-232 Parity — continued

Remember to cover any unused bar codes on this and the facing page to ensure that the scanner reads only the bar code you intend to scan.

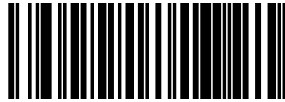

RS-232 PARITY = EVEN



RS-232 PARITY = ODD

RS-232 Hardware Control

Enables/disables use of the RS-232 CTS signal for flow control and/or scan control.

Options are:

- **Disable** — The scanner transmits to the host regardless of any activity on the CTS line.
- **Enable CTS Flow Control** — The CTS signal controls transmission of data to the host.
- **Enable CTS Scan Control** — The CTS line must be active for scanner to read and transmit data. While the CTS line is inactive, scanner remains in a host- disabled state; following a successful label transmission, the CTS signal must transition to inactive and then to active to enable scanning for the next label.

To set this feature:

1. Scan the SWITCH bar code.
2. Scan bar code below or from the following page for the desired setting. You'll need to cover any unused bar codes on facing pages to ensure that the scanner reads only the bar code you intend to scan.
3. Complete the programming sequence by scanning the SWITCH bar code.



RS-232 HARDWARE CONTROL = DISABLE

RS-232 Hardware Control — continued

Remember to cover any unused bar codes on this and the facing page to ensure that the scanner reads only the bar code you intend to scan.

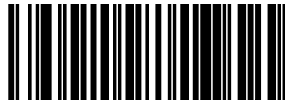

RS-232 HARDWARE CONTROL = ENABLE CTS FLOW CONTROL



RS-232 HARDWARE CONTROL = ENABLE CTS SCAN CONTROL

RS-232 Intercharacter Delay

Specifies delay between the end of one character and the beginning of the next in 10-millisecond increments.

To set the RS-232 Intercharacter Delay:

1. Scan the SWITCH bar code.
2. Scan the bar code below, *SET RS-232 INTERCHARACTER DELAY*. You'll need to cover any unused bar codes on this and the facing page to ensure that the scanner reads only the bar code you intend to scan.
3. Scan the appropriate digits from the keypad in *Appendix C* that represent the desired delay. The selectable range is 0-100, which is the delay in 10-millisecond increments. Pad all single and double digit numbers with leading zeroes to yield a three-digit entry (000-100).

Examples:

001 = 10ms

005 = 50ms

040 = 400ms

100 = 1,000ms (1 second)

4. The scanner will automatically exit Programming Mode when the appropriate amount of digits have been scanned.

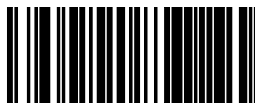

SET RS-232 INTERCHARACTER DELAY

RS-232 Software Flow Control

Enables/disables RS-232 Flow Control using XON/ XOFF characters. .



NOTE

This item will be ignored when the feature, *RS-232 NAK Character*, is enabled

To set this feature:

1. Scan the SWITCH bar code.
2. Scan either the enable or disable bar code below. You'll need to cover any unused bar codes on this and the facing page to ensure that the scanner reads only the bar code you intend to scan.
3. Complete the programming sequence by scanning the SWITCH bar code.



RS-232 SOFTWARE FLOW CONTROL = DISABLE



RS-232 SOFTWARE FLOW CONTROL = ENABLE

RS-232 Host Echo

When enabled, this feature passes all data through the scanner to the host as it comes in. This feature is used for applications where “daisy chaining” of RS-232 devices onto the same cable is necessary. If, for example, one of the devices in the chain is a terminal where someone is entering data while another person is simultaneously scanning a bar code requiring transmission to the host, the scanner will wait for the RS-232 channel to be quiet for a specified period of time (set via *RS-232 Host Echo Quiet Interval*). The scanner can be set to observe this delay before sending its data in order to avoid RS-232 transmission conflicts.



NOTE

When RS-232 Host Echo is enabled, the following features are ignored: **RS-232 Software Flow Control** and **RS-232 ACK NAK Enable** as well as all other ACK/ NAK related operations, plus processing of RS-232 host commands.

To enable/disable this feature:

1. Scan the SWITCH bar code.
2. Scan either the enable or disable bar code below. You'll need to cover any unused bar codes on this and the facing page to ensure that the scanner reads only the bar code you intend to scan.
3. Complete the programming sequence by scanning the SWITCH bar code.

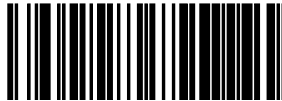

RS-232 HOST ECHO = DISABLE



RS-232 HOST ECHO = ENABLE

RS-232 Host Echo Quiet Interval

This setting specifies the time interval of RS-232 channel inactivity which must transpire before the scanner will break the host echo loop to transmit the bar code data that has just been scanned to the host.

- 0 - 100 = Time in 10-millisecond increments.

To set the Host Echo Quiet Interval:

1. Scan the SWITCH bar code.
2. Scan the bar code below, *SET RS-232 HOST ECHO QUIET INTERVAL*. You'll need to cover any unused bar codes on this and the facing page to ensure that the scanner reads only the bar code you intend to scan.
3. Scan the appropriate digits from the keypad in *Appendix C* that represent the desired timeout. The selectable range is 0-100, which is the timeout in 10-millisecond increments. Pad all single and double digit numbers with leading zeroes to yield a three-digit entry (000-100).

Examples:

001 = 10ms

005 = 50ms

040 = 400ms

100 = 1,000ms (1 second)

4. The scanner will automatically exit Programming Mode when the appropriate amount of digits have been scanned.



SET RS-232 HOST ECHO QUIET INTERVAL

RS-232 Ignore Host Commands

When set to ignore host commands, the scanner will ignore all host commands except for the minimum set necessary to keep the interface active, transmit labels, and transmit scale information. For normal operation of the interface, disable this feature.

To set this feature:

1. Scan the SWITCH bar code.
2. Scan your selection from the bar codes below. You'll need to cover any unused bar codes on this and the facing page to ensure that the scanner reads only the bar code you intend to scan.
3. Complete the programming sequence by scanning the SWITCH bar code.



RS-232 IGNORE HOST COMMANDS = DISABLE



RS-232 IGNORE HOST COMMANDS = ENABLE

RS-232 TTL

Specifies whether RS-232 interface provides TTL levels on the output pins TxD and RTS.

Choices are:

- Normal RS-232 levels
- TTL levels

To set this feature:

1. Scan the SWITCH bar code.
2. Scan the bar code below which represents the desired setting for this feature. You'll need to cover any unused bar codes on this and the facing page to ensure that the scanner reads only the bar code you intend to scan.
3. Complete the programming sequence by scanning the SWITCH bar code.



RS-232 LEVELS = NORMAL RS-232



RS-232 LEVELS = TTL

RS-232 TTL Invert

Enables/disables inversion of TTL.

To set this feature:

1. Scan the SWITCH bar code.
2. Scan the bar code below which represents the desired setting for this feature. You'll need to cover any unused bar codes on this and the facing page to ensure that the scanner reads only the bar code you intend to scan.
3. Complete the programming sequence by scanning the SWITCH bar code.

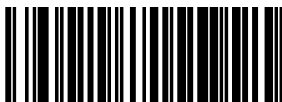

RS-232 TTL INVERT = DISABLE



RS-232 TTL INVERT = ENABLE

RS-232 Beep on ASCII BEL

Enables/disables ability of scanner to beep (sound a good read tone) on receiving an ASCII BEL (07 hex).

- Disable
- Enable

To enable/disable this feature:

1. Scan the SWITCH bar code.
2. Scan either the enable or disable bar code below. You'll need to cover any unused bar codes on this and the facing page to ensure that the scanner reads only the bar code you intend to scan.
3. Complete the programming sequence by scanning the SWITCH bar code.

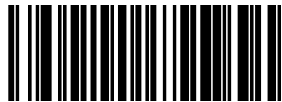

RS-232 BEEP ON ASCII BEL = DISABLE



RS-232 BEEP ON ASCII BEL = ENABLE

RS-232 Beep After Weigh

Enables/disables the ability of the scanner to beep after weight data is transmitted to the host. Scale interfaces that support this item are: RS-232 ICL, RS-232 SASI, and RS-232 Single Cable.

To enable/disable the Beep After Weigh feature:

1. Scan the SWITCH bar code.
2. Scan either the enable or disable bar code below. You'll need to cover any unused bar codes on this and the facing page to ensure that the scanner reads only the bar code you intend to scan.
3. Complete the programming sequence by scanning the SWITCH bar code.

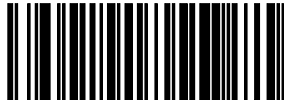

BEEP AFTER WEIGH = DISABLE



BEEP AFTER WEIGH = ENABLE

RS-232 Beep on Not on File

Select for the host to beep (or not) when a not-on-file condition is detected by the host. This feature is also applicable to single cable RS-232.

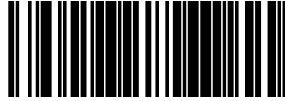

RS-232 BEEP ON NOT ON FILE = DISABLE



ENABLE

RS-232 ACK NAK Enable

This enables/disables the ability of the scanner to support the RS-232 ACK/NAK protocol. When configured, the scanner and/or host sends an “ACK” when it receives data properly, and sends “NAK” when the data is in error. Selections for this option are:

- Disable
- Label Transmission — the scanner expects an ACK/NAK response from the host when a label is sent)
- Host Acknowledgement — Enabled for Host Commands (the scanner will respond with ACK/NAK when the host sends a command)
- Label & Host — Enabled for both Label Transmission & Host Commands

To select the option for RS-232 ACK NAK Enable:

1. Scan the SWITCH bar code.
2. Scan the desired option from bar codes below and on the following page. You’ll need to cover any unused bar codes on this and the facing page to ensure that the scanner reads only the bar code you intend to scan.
3. Complete the programming sequence by scanning the SWITCH bar code.



RS-232 ACK NAK = DISABLE



RS-232 ACK/NAK = LABEL TRANSMISSION

RS-232 ACK NAK Enable — continued

Remember to cover any unused bar codes on this and the facing page to ensure that the scanner reads only the bar code you intend to scan.

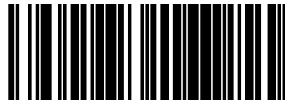

RS-232 ACK/NAK = HOST ACKNOWLEDGEMENT

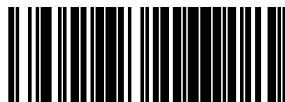

RS-232 ACK/NAK = LABEL & HOST

RS-232 ACK Character

This feature specifies which ASCII character will be used as an ACK character.

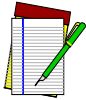

NOTE

DO NOT set this feature to use previously defined characters such as XON, XOFF or host commands as this will conflict with normal operation of these characters. 8-bit data is not recognized when the feature, *RS-232 Number of Data Bits*, is set to 7 data bits.

To specify the RS-232 ACK Character:

1. Scan the SWITCH bar code.
2. Scan the bar code, *SET RS-232 ACK Character* below. You'll need to cover any unused bar codes on this and the facing page to ensure the scanner reads only the bar code you intend to scan.
3. Scan the appropriate digits from the keypad in *Appendix C* that represent the hex designation for the desired character. A table containing the *ASCII Character Set* and their corresponding Hex Values is available in the inside back cover of this manual. ASCII parameters must be input by scanning a pair of hexadecimal digits for the desired character. For example, if ASCII "A" were the desired ACK character, you would scan the digits "4", then "1" (the ASCII corresponding hex value).
4. The scanner will automatically exit Programming Mode when the appropriate amount of digits/characters have been scanned.



SET RS-232 ACK Character

RS-232 NAK Character

This feature specifies which ASCII character will be used as a NAK character.



NOTE

DO NOT set this feature to use previously defined characters such as XON, XOFF or host commands as this will conflict with normal operation of these characters. 8-bit data is not recognized when the feature, **RS-232 Number of Data Bits**, is set to 7 data bits.

To specify the RS-232 NAK Character:

1. Scan the SWITCH bar code.
2. Scan the bar code, *SET RS-232 NAK Character* below. You'll need to cover any unused bar codes on this and the facing page to ensure the scanner reads only the bar code you intend to scan.
3. Scan the appropriate digits from the keypad in *Appendix C* that represent the hex designation for the desired character. A table containing the *ASCII Character Set* and their corresponding Hex Values is available in the inside back cover of this manual. ASCII parameters must be input by scanning a pair of hexadecimal digits for the desired character. For example, if ASCII "A" were the desired NAK character, you would scan the digits "4", then "1" (the ASCII corresponding hex value).
4. The scanner will automatically exit Programming Mode when the appropriate amount of digits/characters have been scanned.

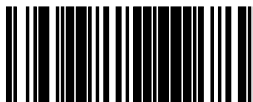

SET RS-232 NAK Character

RS-232 Retry on ACK NAK Timeout

This option specifies the action scanner performs on expiration of the *RS-232 ACK NAK Timeout Value*.

To set this feature:

1. Scan the SWITCH bar code.
2. Scan either the enable or disable bar code below. You'll need to cover any unused bar codes on this and the facing page to ensure that the scanner reads only the bar code you intend to scan.
3. Complete the programming sequence by scanning the SWITCH bar code.



RS-232 RETRY ON ACK NAK TIMEOUT = DISABLE



RS-232 RETRY ON ACK NAK TIMEOUT = ENABLE

RS-232 ACK NAK Timeout Value

This item specifies the time the scanner will wait for an ACK character from the host following a label transmission.

- 0 = Infinite timeout
- 1 - 75 = Timeout in 200-millisecond increments

To set the ACK NAK Timeout Value:

1. Scan the SWITCH bar code.
2. Scan the bar code below, *SET RS-232 ACK NAK TIMEOUT VALUE*. You'll need to cover any unused bar codes on this and the facing page to ensure that the scanner reads only the bar code you intend to scan.
3. Scan the appropriate digits from the keypad in *Appendix C* that represent the desired timeout. A setting of 0 specifies an infinite timeout. The remaining selectable range is 1-75, which is the timeout in 200-millisecond increments. Pad all single digit numbers with a leading zero to yield a two-digit entry (00-75).

Examples:

00 = Infinite timeout

01 = 200ms

05 = 1,000ms (1 second)

40 = 8,000ms (8 seconds)

75 = 15,000ms (15 seconds)

4. The scanner will automatically exit Programming Mode when the appropriate amount of digits have been scanned.



SET RS-232 ACK NAK TIMEOUT VALUE

RS-232 ACK NAK Retry Count

This feature sets the number of times for the scanner to retry a label transmission under a retry condition.

To set the RS-232 ACK NAK Retry Count:

1. Scan the SWITCH bar code.
2. Scan the bar code, *SET RS-232 ACK NAK RETRY COUNT* below. You'll need to cover any unused bar codes on this and the facing page to ensure that the scanner reads only the bar code you intend to scan.
3. Scan the appropriate digits from the keypad in *Appendix C* that represent the desired number. The selectable range is 0-255 resets. Pad all single and double digit numbers with leading zeroes to yield a three-digit entry (000-255).



NOTE

A setting of 255 specifies "retry forever."

4. The scanner will automatically exit Programming Mode when the appropriate amount of digits have been scanned.



SET RS-232 ACK NAK RETRY COUNT

RS-232 ACK NAK Error Handling

This item specifies the method the scanner will use to handle errors detected while waiting to receive the ACK character from the host. Errors include unrecognized host commands and communication errors such as parity or framing errors.

- Ignore Errors (recommended setting)
- Assume ACK (risk of lost label data)
- Assume NAK (risk of duplicate label)

To select the option for RS-232 ACK NAK Error Handling:

1. Scan the SWITCH bar code.
2. Scan the desired option from the bar codes below. You'll need to cover any unused bar codes on this and the facing page to ensure that the scanner reads only the bar code you intend to scan.
3. Complete the programming sequence by scanning the SWITCH bar code.

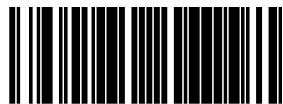

RS-232 ACK NAK ERROR HANDLING = IGNORE ERRORS

RS-232 ACK NAK Error Handling — continued

Remember to cover any unused bar codes on this and the facing page to ensure that the scanner reads only the bar code you intend to scan.

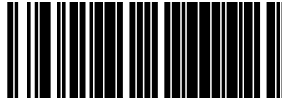

RS-232 ACK NAK ERROR HANDLING = ASSUME ACK

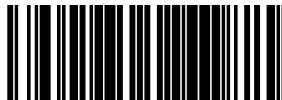

RS-232 ACK NAK ERROR HANDLING = ASSUME NAK

RS-232 Label ID Control

This feature specifies whether or not Label IDs are transmitted to the host and if so, whether to attach them as a prefix or suffix.

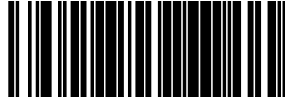

RS-232 LABEL ID CONTROL = DISABLE

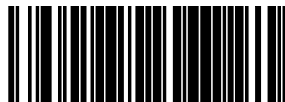

RS-232 LABEL ID CONTROL = ENABLE AS PREFIX

RS-232 Label ID Control — continued

Remember to cover any unused bar codes on this and the facing page to ensure that the scanner reads only the bar code you intend to scan.

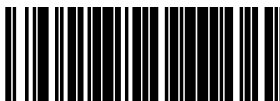

RS-232 LABEL ID CONTROL = ENABLE AS SUFFIX

Single Cable RS-232 Options

The RS-232 Single Cable interface shares some configuration options with other RS-232 interfaces. Rather than repeat them in this section as Single Cable options, please find them referenced as follows:

- [RS-232 Baud Rate on page 68](#)
- [RS-232 Number of Data Bits on page 72](#)
- [RS-232 Number of Stop Bits on page 73](#)
- [RS-232 Parity on page 74](#)
- [RS-232 Software Flow Control on page 79](#)
- [RS-232 Beep After Weigh on page 86](#)
- [RS-232 Beep on Not on File on page 87](#)
- [RS-232 Label ID Control on page 97](#)

Single Cable RS-232 Scanner Only Protocol

This sets the type of interface protocol that will be used in Single Cable RS-232.

Options are:

- Scanner/scale RS-232 protocol
- Scanner only RS-232 protocol

To set this feature:

1. Scan the SWITCH bar code.
2. Scan the bar code below representing the desired option. You'll need to cover any unused bar codes on this and the facing page to ensure that the scanner reads only the bar code you intend to scan.
3. Complete the programming sequence by scanning the SWITCH bar code.

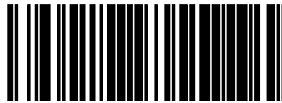

SINGLE CABLE RS-232 PROTOCOL = SCANNER/SCALE



SINGLE CABLE RS-232 PROTOCOL = SCANNER ONLY

Single Cable RS-232 RTS CTS Selection

Specifies how RTS and CTS are used to control the data flow. RTS is controlled by the Scanner and can be continuously held high/low, or can be asserted during label transmission. The scanner looks at CTS, as the configuration values state, to determine when to send label data.

Choices are:

- Option 0 = RTS is held in low state and CTS is ignored
- Option 1 = RTS is held in high state and CTS is ignored
- Option 2 = Assert RTS and wait for CTS to be asserted
- Option 3 = Assert RTS and ignore CTS
- Option 4 = RTS held low, wait for CTS to be asserted
- Option 5 = RTS held high, wait for CTS to be asserted

To set this feature:

1. Scan the SWITCH bar code.
2. Scan a bar code below or on the following pages representing the desired option. You'll need to cover any unused bar codes, as well as facing pages to ensure that the scanner reads only the bar code you intend to scan.
3. Complete the programming sequence by scanning the SWITCH bar code.

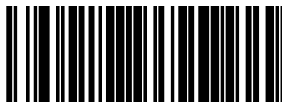

RTS CTS SELECTION = OPTION 0

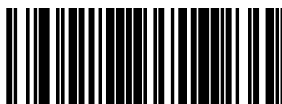

RTS CTS SELECTION = OPTION 1

Single Cable RS-232 RTS CTS Selection — continued

Remember to cover any unused bar codes on this and the facing page to ensure that the scanner reads only the bar code you intend to scan.

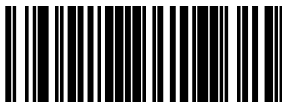

RTS CTS SELECTION = OPTION 2



RTS CTS SELECTION = OPTION 3

Single Cable RS-232 RTS CTS Selection — continued

Remember to cover any unused bar codes on this and the facing page to ensure that the scanner reads only the bar code you intend to scan.

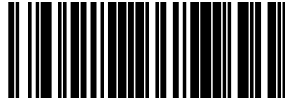

RTS CTS SELECTION = OPTION 4



RTS CTS SELECTION = OPTION 5

Single Cable RS-232 Use BCC

Enables/disables the ability of the scanner to use BCC.

To set this feature:

1. Scan the SWITCH bar code.
2. Scan either the enable or disable bar code below. You'll need to cover any unused bar codes on this and the facing page to ensure that the scanner reads only the bar code you intend to scan.
3. Complete the programming sequence by scanning the SWITCH bar code.

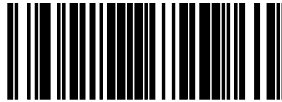

SINGLE CABLE RS-232 USE BCC = DISABLE



SINGLE CABLE RS-232 USE BCC = ENABLE

Single Cable RS-232 Use ACK/NAK

Enables/disables the ability of the scanner to use ACK/NAK.

To set this feature:

1. Scan the SWITCH bar code.
2. Scan either the enable or disable bar code below. You'll need to cover any unused bar codes on this and the facing page to ensure that the scanner reads only the bar code you intend to scan.
3. Complete the programming sequence by scanning the SWITCH bar code.

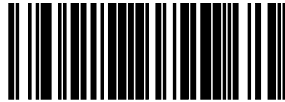

SINGLE CABLE RS-232 USE ACK/NAK = DISABLE



SINGLE CABLE RS-232 USE ACK/NAK = ENABLE

Single Cable RS-232 Use STX

Enables/disables the ability of the scanner to use STX.

To set this feature:

1. Scan the SWITCH bar code.
2. Scan either the enable or disable bar code below. You'll need to cover any unused bar codes on this and the facing page to ensure that the scanner reads only the bar code you intend to scan.
3. Complete the programming sequence by scanning the SWITCH bar code.

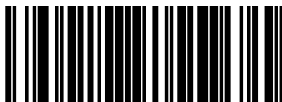

SINGLE CABLE RS-232 USE STX = DISABLE

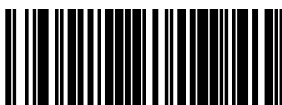

SINGLE CABLE RS-232 USE STX = ENABLE

Set Single Cable RS-232 STX Character

This feature selects the STX character.

To specify the STX Character:

1. Scan the SWITCH bar code.
2. Scan the bar code, *SET SINGLE CABLE RS-232 STX CHARACTER* below. You'll need to cover any unused bar codes on this and the facing page to ensure the scanner reads only the bar code you intend to scan.
3. Scan the appropriate characters/digits from the keypad in *Appendix C* that represent the decimal designation for the desired character. A table containing the *ASCII Character Set* and their corresponding decimal values is available in the inside back cover of this manual. ASCII parameters must be input by scanning decimal digits for each character. Pad all numbers with leading zeroes to yield a three-digit entry (001-127). Thus, to set a single character value of A, bar codes containing the digits '0', '6' and '5' must be scanned. The selectable range for this option is any decimal value from 001 to 127.
4. The scanner will automatically exit Programming Mode when the appropriate amount of digits have been scanned.

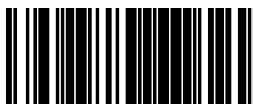

SET SINGLE CABLE RS-232 STX CHARACTER

Single Cable RS-232 Use ETX

Enables/disables the ability of the scanner to use ETX.

To set this feature:

1. Scan the SWITCH bar code.
2. Scan either the enable or disable bar code below. You'll need to cover any unused bar codes on this and the facing page to ensure that the scanner reads only the bar code you intend to scan.
3. Complete the programming sequence by scanning the SWITCH bar code.

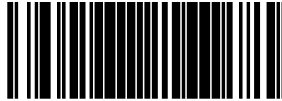

SINGLE CABLE RS-232 USE ETX = DISABLE

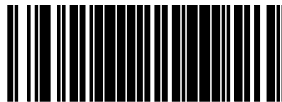

SINGLE CABLE RS-232 USE ETX = ENABLE

Set Single Cable RS-232 ETX Character

Allows selection of the ETX character.

To specify the ETX Character:

1. Scan the SWITCH bar code.
2. Scan the bar code, *SET SINGLE CABLE RS-232 ETX CHARACTER* below. You'll need to cover any unused bar codes on this and the facing page to ensure the scanner reads only the bar code you intend to scan.
3. Scan the appropriate characters/digits from the keypad in *Appendix C* that represent the decimal designation for the desired character. A table containing the *ASCII Character Set* and their corresponding decimal values is available in the inside back cover of this manual. ASCII parameters must be input by scanning decimal digits for each character. Pad all numbers with leading zeroes to yield a three-digit entry (001-127). Thus, to set a single character value of A, bar codes containing the digits '0', '6' and '5' must be scanned. The selectable range for this option is any decimal value from 001 to 127.
4. The scanner will automatically exit Programming Mode when the appropriate amount of digits have been scanned.

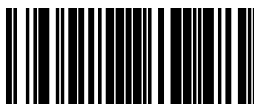

SET SINGLE CABLE RS-232 ETX CHARACTER

Single Cable RS-232 Datalogic Extensions

When Datalogic extensions are enabled, scale calibration mode information is communicated to the host. Contact Customer Support for the format of this information. Choices for this feature are:

- Standard Protocol
- Support Datalogic Extensions to Protocol

To set this feature:

1. Scan the SWITCH bar code.
2. Scan your selection from the bar codes below. You'll need to cover any unused bar codes on this and the facing page to ensure that the scanner reads only the bar code you intend to scan.
3. Complete the programming sequence by scanning the SWITCH bar code.

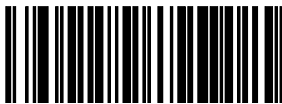

SINGLE CABLE RS-232 DATALOGIC EXTENSIONS = STANDARD PROTOCOL



SINGLE CABLE RS-232 DATALOGIC EXTENSIONS = SUPPORT DATALOGIC
EXTENSIONS TO PROTOCOL

Symbology Programming



NOTE

If the scanner's interface type must be changed, always be sure that interface configuration is the **FIRST** item scanned during a programming session. (Selecting an interface type resets **ALL** other configuration items — including symbology programming — to the factory default for that interface type.)

UPC-A Enable

Enables/disables the ability of the scanner to decode UPC-A labels.

To set this feature:

1. Scan the SWITCH bar code.
2. Scan either the enable or disable bar code below. You'll need to cover any unused bar codes on this and the facing page to ensure that the scanner reads only the bar code you intend to scan.
3. Complete the programming sequence by scanning the SWITCH bar code.



UPC-A = DISABLE



UPC-A = ENABLE

UPC-A Number System Character Transmission

Enables/disables transmission of a UPC-A number system character.



NOTE

This feature MUST be enabled for IBM interfaces for proper function.

This item is ignored when the advanced feature, Full Label Edit, is enabled.

To set this feature:

1. Scan the SWITCH bar code.
2. Scan either the enable or disable bar code below. You'll need to cover any unused bar codes on this and the facing page to ensure that the scanner reads only the bar code you intend to scan.
3. Complete the programming sequence by scanning the SWITCH bar code.

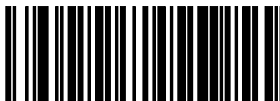

UPC-A NUMBER SYSTEM CHARACTER TRANSMISSION = DISABLE



UPC-A NUMBER SYSTEM CHARACTER TRANSMISSION = ENABLE

UPC-A Check Character Transmission

Enables/disables transmission of a UPC-A check character.



NOTE

This item is ignored when the advanced feature, Full Label Edit, is enabled.

To set this feature:

1. Scan the SWITCH bar code.
2. Scan either the enable or disable bar code below. You'll need to cover any unused bar codes on this and the facing page to ensure that the scanner reads only the bar code you intend to scan.
3. Complete the programming sequence by scanning the SWITCH bar code.

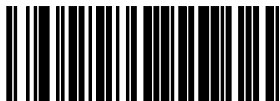

UPC-A CHECK CHARACTER TRANSMISSION = DISABLE



UPC-A CHECK CHARACTER TRANSMISSION = ENABLE

Expand UPC-A to EAN-13

Enables/disables expansion of UPC-A labels to EAN/JAN-13.

To set this feature:

1. Scan the SWITCH bar code.
2. Scan either the enable or disable bar code below. You'll need to cover any unused bar codes on this and the facing page to ensure that the scanner reads only the bar code you intend to scan.
3. Complete the programming sequence by scanning the SWITCH bar code.



EXPAND UPC-A TO EAN/JAN-13 = DISABLE



EXPAND UPC-A TO EAN/JAN-13 = ENABLE

UPC/EAN AIM ID

This feature enables/disables transmission of the UPC/EAN AIM symbology identifier.

To set this feature:

1. Scan the SWITCH bar code.
2. Scan your selection from the bar codes below. You'll need to cover any unused bar codes on this and the facing page to ensure that the scanner reads only the bar code you intend to scan.
3. Complete the programming sequence by scanning the SWITCH bar code.



UPC/EAN AIM ID = DISABLE



UPC/EAN AIM ID = ENABLE

UPC-A Label ID

This feature specifies a UPC-A label ID to be added to bar code data.

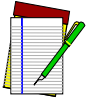

NOTE

The programming feature, ***RS-232 Label ID Control***, designates whether the Label ID is transmitted as a prefix or suffix or if Label ID is disabled.

To set this feature:

1. Scan the SWITCH bar code.
2. Scan the bar code, *SET UPC-A LABEL ID* below. You'll need to cover any unused bar codes on this and the facing page to ensure the scanner reads only the bar code you intend to scan.
3. Scan the appropriate digits from the keypad in *Appendix C* that represent the desired Label ID characters; entered as two hex pairs. A table containing the *ASCII Character Set* and their corresponding Hex Values is available in the inside back cover of this manual. ASCII parameters must be input by scanning a pair of hexadecimal digits for each character. Thus, to set a two-character value of AB, bar codes containing the digits '4', '1', '4', and '2' must be scanned. The selectable range for this option is any hex value from 00 to FF.
4. Complete the programming sequence by scanning the SWITCH bar code.

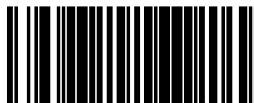

SET UPC-A LABEL ID

UPC-A 2-Digit Supplemental Label ID

This feature specifies a UPC-A 2-Digit Supplemental label ID to be added to bar code data.



NOTE

The programming feature, *RS-232 Label ID Control*, designates whether the Label ID is transmitted as a prefix or suffix or if Label ID is disabled.

To set this feature:

1. Scan the SWITCH bar code.
2. Scan the bar code, *SET UPC-A 2-DIGIT SUPPLEMENTAL LABEL ID* below. You'll need to cover any unused bar codes on this and the facing page to ensure the scanner reads only the bar code you intend to scan.
3. Scan the appropriate digits from the keypad in *Appendix C* that represent the desired Label ID characters; entered as two hex pairs. A table containing the *ASCII Character Set* and their corresponding Hex Values is available in the inside back cover of this manual. ASCII parameters must be input by scanning a pair of hexadecimal digits for each character. Thus, to set a two-character value of AB, bar codes containing the digits '4', '1', '4', and '2' must be scanned. The selectable range for this option is any hex value from 00 to FF.
4. Complete the programming sequence by scanning the SWITCH bar code.



SET UPC-A 2-DIGIT SUPPLEMENTAL LABEL ID

UPC-A 5-Digit Supplemental Label ID

This feature specifies a UPC-A 5-Digit Supplemental label ID to be added to bar code data.



NOTE

The programming feature, ***RS-232 Label ID Control***, designates whether the Label ID is transmitted as a prefix or suffix or if Label ID is disabled.

To set this feature:

1. Scan the SWITCH bar code.
2. Scan the bar code, *SET UPC-A 5-DIGIT SUPPLEMENTAL LABEL ID* below. You'll need to cover any unused bar codes on this and the facing page to ensure the scanner reads only the bar code you intend to scan.
3. Scan the appropriate digits from the keypad in *Appendix C* that represent the desired Label ID characters; entered as two hex pairs. A table containing the *ASCII Character Set* and their corresponding Hex Values is available in the inside back cover of this manual. ASCII parameters must be input by scanning a pair of hexadecimal digits for each character. Thus, to set a two-character value of AB, bar codes containing the digits '4', '1', '4', and '2' must be scanned. The selectable range for this option is any hex value from 00 to FF.
4. Complete the programming sequence by scanning the SWITCH bar code.



SET UPC-A 5-DIGIT SUPPLEMENTAL LABEL ID

UPC-A 128 Supplemental Label ID

This feature specifies a UPC-A 128 Supplemental label ID to be added to bar code data.



NOTE

The programming feature, *RS-232 Label ID Control*, designates whether the Label ID is transmitted as a prefix or suffix or if Label ID is disabled.

To set this feature:

1. Scan the SWITCH bar code.
2. Scan the bar code, *SET UPC-A 128 SUPPLEMENTAL LABEL ID* below. You'll need to cover any unused bar codes on this and the facing page to ensure the scanner reads only the bar code you intend to scan.
3. Scan the appropriate digits from the keypad in *Appendix C* that represent the desired Label ID characters; entered as two hex pairs. A table containing the *ASCII Character Set* and their corresponding Hex Values is available in the inside back cover of this manual. ASCII parameters must be input by scanning a pair of hexadecimal digits for each character. Thus, to set a two-character value of AB, bar codes containing the digits '4', '1', '4', and '2' must be scanned. The selectable range for this option is any hex value from 00 to FF.
4. Complete the programming sequence by scanning the SWITCH bar code.

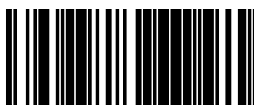

SET UPC-A 128 SUPPLEMENTAL LABEL ID

UPC-E Enable

Enables/disables the ability of the scanner to decode UPC-E labels.

To set this feature:

1. Scan the SWITCH bar code.
2. Scan either the enable or disable bar code below. You'll need to cover any unused bar codes on this and the facing page to ensure that the scanner reads only the bar code you intend to scan.
3. Complete the programming sequence by scanning the SWITCH bar code.

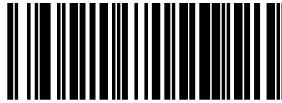

UPC-E = DISABLE



UPC-E = ENABLE

UPC-E Number System Character Transmission

Enables/disables transmission of a UPC-E number system character.



NOTE

This item is ignored when the advanced feature, Full Label Edit, is enabled.

To set this feature:

1. Scan the SWITCH bar code.
2. Scan either the enable or disable bar code below. You'll need to cover any unused bar codes on this and the facing page to ensure that the scanner reads only the bar code you intend to scan.
3. Complete the programming sequence by scanning the SWITCH bar code.



UPC-E NUMBER SYSTEM CHARACTER TRANSMISSION = DISABLE

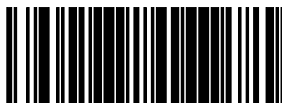

UPC-E NUMBER SYSTEM CHARACTER TRANSMISSION = ENABLE

UPC-E Check Character Transmission

Enables/disables transmission of a UPC-E check character.



NOTE

This item is ignored when the advanced feature, Full Label Edit, is enabled.

To set this feature:

1. Scan the SWITCH bar code.
2. Scan either the enable or disable bar code below. You'll need to cover any unused bar codes on this and the facing page to ensure that the scanner reads only the bar code you intend to scan.
3. Complete the programming sequence by scanning the SWITCH bar code.

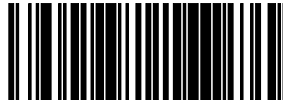

UPC-E CHECK CHARACTER TRANSMISSION = DISABLE



UPC-E CHECK CHARACTER TRANSMISSION = ENABLE

Expand UPC-E to UPC-A

Enables/disables expansion of UPC-E labels to UPC-A.

To set this feature:

1. Scan the SWITCH bar code.
2. Scan either the enable or disable bar code below. You'll need to cover any unused bar codes on this and the facing page to ensure that the scanner reads only the bar code you intend to scan.
3. Complete the programming sequence by scanning the SWITCH bar code.



EXPAND UPC-E TO UPC-A = DISABLE



EXPAND UPC-E TO UPC-A = ENABLE

Expand UPC-E to EAN-13

Enables/disables expansion of UPC-E labels to EAN/JAN-13.

To set this feature:

1. Scan the SWITCH bar code.
2. Scan either the enable or disable bar code below. You'll need to cover any unused bar codes on this and the facing page to ensure that the scanner reads only the bar code you intend to scan.
3. Complete the programming sequence by scanning the SWITCH bar code.

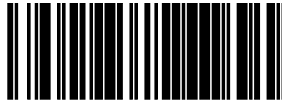

EXPAND UPC-E TO EAN/JAN-13 = DISABLE



EXPAND UPC-E TO EAN/JAN-13 = ENABLE

UPC-E Label ID

This feature specifies a UPC-E label ID to be added to bar code data.



NOTE

The programming feature, ***RS-232 Label ID Control***, designates whether the Label ID is transmitted as a prefix or suffix or if Label ID is disabled.

To set this feature:

1. Scan the SWITCH bar code.
2. Scan the bar code, *SET UPC-E LABEL ID* below. You'll need to cover any unused bar codes on this and the facing page to ensure the scanner reads only the bar code you intend to scan.
3. Scan the appropriate digits from the keypad in *Appendix C* that represent the desired Label ID characters; entered as two hex pairs. A table containing the *ASCII Character Set* and their corresponding Hex Values is available in the inside back cover of this manual. ASCII parameters must be input by scanning a pair of hexadecimal digits for each character. Thus, to set a two-character value of AB, bar codes containing the digits '4', '1', '4', and '2' must be scanned. The selectable range for this option is any hex value from 00 to FF.
4. Complete the programming sequence by scanning the SWITCH bar code.

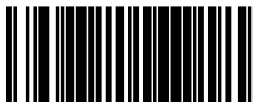

SET UPC-E LABEL ID

UPC-E 2-Digit Supplemental Label ID

This feature specifies a UPC-E 2-Digit Supplemental label ID to be added to bar code data.



NOTE

The programming feature, *RS-232 Label ID Control*, designates whether the Label ID is transmitted as a prefix or suffix or if Label ID is disabled.

To set this feature:

1. Scan the SWITCH bar code.
2. Scan the bar code, *SET UPC-E 2-DIGIT SUPPLEMENTAL LABEL ID* below. You'll need to cover any unused bar codes on this and the facing page to ensure the scanner reads only the bar code you intend to scan.
3. Scan the appropriate digits from the keypad in *Appendix C* that represent the desired Label ID characters; entered as two hex pairs. A table containing the *ASCII Character Set* and their corresponding Hex Values is available in the inside back cover of this manual. ASCII parameters must be input by scanning a pair of hexadecimal digits for each character. Thus, to set a two-character value of AB, bar codes containing the digits '4', '1', '4', and '2' must be scanned. The selectable range for this option is any hex value from 00 to FF.
4. Complete the programming sequence by scanning the SWITCH bar code.

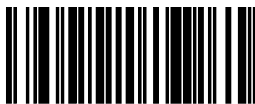

SET UPC-E 2-DIGIT SUPPLEMENTAL LABEL ID

UPC-E 5-Digit Supplemental Label ID

This feature specifies a UPC-E 5-Digit Supplemental label ID to be added to bar code data.



NOTE

The programming feature, ***RS-232 Label ID Control***, designates whether the Label ID is transmitted as a prefix or suffix or if Label ID is disabled.

To set this feature:

1. Scan the SWITCH bar code.
2. Scan the bar code, *SET UPC-E 5-DIGIT SUPPLEMENTAL LABEL ID* below. You'll need to cover any unused bar codes on this and the facing page to ensure the scanner reads only the bar code you intend to scan.
3. Scan the appropriate digits from the keypad in *Appendix C* that represent the desired Label ID characters; entered as two hex pairs. A table containing the *ASCII Character Set* and their corresponding Hex Values is available in the inside back cover of this manual. ASCII parameters must be input by scanning a pair of hexadecimal digits for each character. Thus, to set a two-character value of AB, bar codes containing the digits '4', '1', '4', and '2' must be scanned. The selectable range for this option is any hex value from 00 to FF.
4. Complete the programming sequence by scanning the SWITCH bar code.

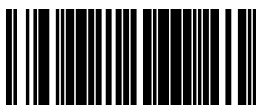

SET UPC-E 5-DIGIT SUPPLEMENTAL LABEL ID

UPC-E 128 Supplemental Label ID

This feature specifies a UPC-E 128 Supplemental label ID to be added to bar code data.

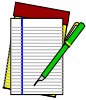

NOTE

The programming feature, ***RS-232 Label ID Control***, designates whether the Label ID is transmitted as a prefix or suffix or if Label ID is disabled.

To set this feature:

1. Scan the SWITCH bar code.
2. Scan the bar code, *SET UPC-E 128 SUPPLEMENTAL LABEL ID* below. You'll need to cover any unused bar codes on this and the facing page to ensure the scanner reads only the bar code you intend to scan.
3. Scan the appropriate digits from the keypad in *Appendix C* that represent the desired Label ID characters; entered as two hex pairs. A table containing the *ASCII Character Set* and their corresponding Hex Values is available in the inside back cover of this manual. ASCII parameters must be input by scanning a pair of hexadecimal digits for each character. Thus, to set a two-character value of AB, bar codes containing the digits '4', '1', '4', and '2' must be scanned. The selectable range for this option is any hex value from 00 to FF.
4. Complete the programming sequence by scanning the SWITCH bar code.

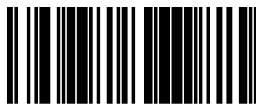

SET UPC-E 128 SUPPLEMENTAL LABEL ID

EAN-13 Enable

Enables/disables the ability of the scanner to decode EAN/JAN-13 labels.

To set this feature:

1. Scan the SWITCH bar code.
2. Scan either the enable or disable bar code below. You'll need to cover any unused bar codes on this and the facing page to ensure that the scanner reads only the bar code you intend to scan.
3. Complete the programming sequence by scanning the SWITCH bar code.

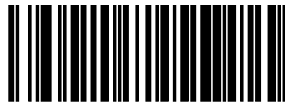

EAN-13 = DISABLE



EAN-13 = ENABLE

EAN-13 First Character Transmission

Enables/disables transmission of EAN/JAN-13 first character.



NOTE

This item is ignored when the advanced feature, Full Label Edit, is enabled.

To set this feature:

1. Scan the SWITCH bar code.
2. Scan either the enable or disable bar code below. You'll need to cover any unused bar codes on this and the facing page to ensure that the scanner reads only the bar code you intend to scan.
3. Complete the programming sequence by scanning the SWITCH bar code.



EAN-13 FIRST CHARACTER TRANSMISSION = DISABLE



EAN-13 FIRST CHARACTER TRANSMISSION = ENABLE

EAN-13 Check Character Transmission

Enables/disables transmission of an EAN/JAN-13 check character.



NOTE

This item is ignored when the advanced feature, Full Label Edit, is enabled.

To set this feature:

1. Scan the SWITCH bar code.
2. Scan either the enable or disable bar code below. You'll need to cover any unused bar codes on this and the facing page to ensure that the scanner reads only the bar code you intend to scan.
3. Complete the programming sequence by scanning the SWITCH bar code.



EAN-13 CHECK CHARACTER TRANSMISSION = DISABLE



EAN-13 CHECK CHARACTER TRANSMISSION = ENABLE

EAN-13 ISBN Conversion Enable

Enables/disables conversion of EAN/JAN-13 labels starting with 978 to Bookland ISBN labels.



NOTE

If any add-on information is present on the label prior to the conversion to ISBN, the add-on data will be discarded. Only the base label will be converted.

To set this feature:

1. Scan the SWITCH bar code.
2. Scan either the enable or disable bar code below. You'll need to cover any unused bar codes on this and the facing page to ensure that the scanner reads only the bar code you intend to scan.
3. Complete the programming sequence by scanning the SWITCH bar code.



EAN-13 ISBN Conversion= DISABLE



EAN-13 ISBN Conversion = ENABLE

EAN 13 Label ID

This feature specifies an EAN 13 label ID to be added to bar code data.

To set this feature:



NOTE

The programming feature, *RS-232 Label ID Control*, designates whether the Label ID is transmitted as a prefix or suffix or if Label ID is disabled.

To set this feature:

1. Scan the SWITCH bar code.
2. Scan the bar code, *SET EAN 13 LABEL ID* below. You'll need to cover any unused bar codes on this and the facing page to ensure the scanner reads only the bar code you intend to scan.
3. Scan the appropriate digits from the keypad in *Appendix C* that represent the desired Label ID characters; entered as two hex pairs. A table containing the *ASCII Character Set* and their corresponding Hex Values is available in the inside back cover of this manual. ASCII parameters must be input by scanning a pair of hexadecimal digits for each character. Thus, to set a two-character value of AB, bar codes containing the digits '4', '1', '4', and '2' must be scanned. The selectable range for this option is any hex value from 00 to FF.
4. Complete the programming sequence by scanning the SWITCH bar code.

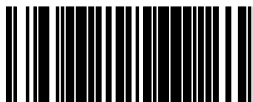

SET EAN 13 LABEL ID

EAN-13 2-Digit Supplemental Label ID

This feature specifies an EAN-13 2-Digit Supplemental label ID to be added to bar code data.



NOTE

The programming feature, ***RS-232 Label ID Control***, designates whether the Label ID is transmitted as a prefix or suffix or if Label ID is disabled.

To set this feature:

1. Scan the SWITCH bar code.
2. Scan the bar code, *SET EAN-13 2-DIGIT SUPPLEMENTAL LABEL ID* below. You'll need to cover any unused bar codes on this and the facing page to ensure the scanner reads only the bar code you intend to scan.
3. Scan the appropriate digits from the keypad in *Appendix C* that represent the desired Label ID characters; entered as two hex pairs. A table containing the *ASCII Character Set* and their corresponding Hex Values is available in the inside back cover of this manual. ASCII parameters must be input by scanning a pair of hexadecimal digits for each character. Thus, to set a two-character value of AB, bar codes containing the digits '4', '1', '4', and '2' must be scanned. The selectable range for this option is any hex value from 00 to FF.
4. Complete the programming sequence by scanning the SWITCH bar code.

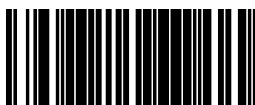

SET EAN-13 2-DIGIT SUPPLEMENTAL LABEL ID

EAN-13 5-Digit Supplemental Label ID

This feature specifies an EAN-13 5-Digit Supplemental label ID to be added to bar code data.



NOTE

The programming feature, ***RS-232 Label ID Control***, designates whether the Label ID is transmitted as a prefix or suffix or if Label ID is disabled.

To set this feature:

1. Scan the SWITCH bar code.
2. Scan the bar code, *SET EAN-13 5-DIGIT SUPPLEMENTAL LABEL ID* below. You'll need to cover any unused bar codes on this and the facing page to ensure the scanner reads only the bar code you intend to scan.
3. Scan the appropriate digits from the keypad in *Appendix C* that represent the desired Label ID characters; entered as two hex pairs. A table containing the *ASCII Character Set* and their corresponding Hex Values is available in the inside back cover of this manual. ASCII parameters must be input by scanning a pair of hexadecimal digits for each character. Thus, to set a two-character value of AB, bar codes containing the digits '4', '1', '4', and '2' must be scanned. The selectable range for this option is any hex value from 00 to FF.
4. Complete the programming sequence by scanning the SWITCH bar code.

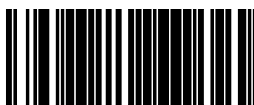

SET EAN-13 5-DIGIT SUPPLEMENTAL LABEL ID

EAN-13 128 Supplemental Label ID

This feature specifies an EAN-13 128 Supplemental label ID to be added to bar code data.



NOTE

The programming feature, ***RS-232 Label ID Control***, designates whether the Label ID is transmitted as a prefix or suffix or if Label ID is disabled.

To set this feature:

1. Scan the SWITCH bar code.
2. Scan the bar code, *SET EAN-13 128 SUPPLEMENTAL LABEL ID = DISABLE* below. You'll need to cover any unused bar codes on this and the facing page to ensure the scanner reads only the bar code you intend to scan.
3. Scan the appropriate digits from the keypad in *Appendix C* that represent the desired Label ID characters; entered as two hex pairs. A table containing the *ASCII Character Set* and their corresponding Hex Values is available in the inside back cover of this manual. ASCII parameters must be input by scanning a pair of hexadecimal digits for each character. Thus, to set a two-character value of AB, bar codes containing the digits '4', '1', '4', and '2' must be scanned. The selectable range for this option is any hex value from 00 to FF.
4. Complete the programming sequence by scanning the SWITCH bar code.



SET EAN-13 128 SUPPLEMENTAL LABEL ID = DISABLE

Bookland AIM ID

This feature enables/disables transmission of the Bookland AIM symbology identifier.

To set this feature:

1. Scan the SWITCH bar code.
2. Scan your selection from the bar codes below. You'll need to cover any unused bar codes on this and the facing page to ensure that the scanner reads only the bar code you intend to scan.
3. Complete the programming sequence by scanning the SWITCH bar code.



BOOKLAND AIM ID = DISABLE



BOOKLAND AIM ID = ENABLE

Bookland Label ID

This feature specifies a Bookland label ID to be added to bar code data.

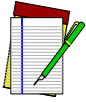

NOTE

The programming feature, ***RS-232 Label ID Control***, designates whether the Label ID is transmitted as a prefix or suffix or if Label ID is disabled.

To set this feature:

1. Scan the SWITCH bar code.
2. Scan the bar code, *SET BOOKLAND LABEL ID* below. You'll need to cover any unused bar codes on this and the facing page to ensure the scanner reads only the bar code you intend to scan.
3. Scan the appropriate digits from the keypad in *Appendix C* that represent the desired Label ID characters; entered as two hex pairs. A table containing the *ASCII Character Set* and their corresponding Hex Values is available in the inside back cover of this manual. ASCII parameters must be input by scanning a pair of hexadecimal digits for each character. Thus, to set a two-character value of AB, bar codes containing the digits '4', '1', '4', and '2' must be scanned. The selectable range for this option is any hex value from 00 to FF.
4. Complete the programming sequence by scanning the SWITCH bar code.



SET BOOKLAND LABEL ID

EAN-8 Enable

Enables/disables the ability of the scanner to decode EAN/JAN-8 labels.

To set this feature:

1. Scan the SWITCH bar code.
2. Scan either the enable or disable bar code below. You'll need to cover any unused bar codes on this and the facing page to ensure that the scanner reads only the bar code you intend to scan.
3. Complete the programming sequence by scanning the SWITCH bar code.



EAN-8 = DISABLE



EAN-8 = ENABLE

EAN-8 Check Character Transmission

Enables/disables transmission of an EAN/JAN-8 check character.



NOTE

This item is ignored when the advanced feature, Full Label Edit, is enabled.

To set this feature:

1. Scan the SWITCH bar code.
2. Scan either the enable or disable bar code below. You'll need to cover any unused bar codes on this and the facing page to ensure that the scanner reads only the bar code you intend to scan.
3. Complete the programming sequence by scanning the SWITCH bar code.



EAN-8 CHECK CHARACTER TRANSMISSION = DISABLE



EAN-8 CHECK CHARACTER TRANSMISSION = ENABLE

Expand EAN-8 to EAN-13

Enables/disables expansion of EAN/JAN-8 labels to EAN/JAN-13.

To set this feature:

1. Scan the SWITCH bar code.
2. Scan either the enable or disable bar code below. You'll need to cover any unused bar codes on this and the facing page to ensure that the scanner reads only the bar code you intend to scan.
3. Complete the programming sequence by scanning the SWITCH bar code.

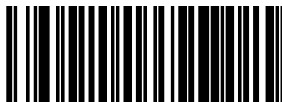

EXPAND EAN/JAN-8 TO EAN/JAN-13 = DISABLE



EXPAND EAN/JAN-8 TO EAN/JAN-13 = ENABLE

EAN 8 Label ID

This feature specifies an EAN 8 label ID to be added to bar code data.
To set this feature:



NOTE

The programming feature, ***RS-232 Label ID Control***, designates whether the Label ID is transmitted as a prefix or suffix or if Label ID is disabled.

To set this feature:

1. Scan the SWITCH bar code.
2. Scan the bar code, *SET EAN 8 LABEL ID* below. You'll need to cover any unused bar codes on this and the facing page to ensure the scanner reads only the bar code you intend to scan.
3. Scan the appropriate digits from the keypad in *Appendix C* that represent the desired Label ID characters; entered as two hex pairs. A table containing the *ASCII Character Set* and their corresponding Hex Values is available in the inside back cover of this manual. ASCII parameters must be input by scanning a pair of hexadecimal digits for each character. Thus, to set a two-character value of AB, bar codes containing the digits '4', '1', '4', and '2' must be scanned. The selectable range for this option is any hex value from 00 to FF.
4. Complete the programming sequence by scanning the SWITCH bar code.

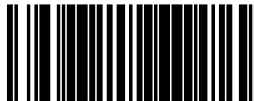

SET EAN 8 LABEL ID

EAN-8 2-Digit Supplemental Label ID

This feature specifies an EAN-8 2-Digit Supplemental label ID to be added to bar code data.



NOTE

The programming feature, ***RS-232 Label ID Control***, designates whether the Label ID is transmitted as a prefix or suffix or if Label ID is disabled.

To set this feature:

1. Scan the SWITCH bar code.
2. Scan the bar code, *SET EAN-8 2-DIGIT SUPPLEMENTAL LABEL ID* below. You'll need to cover any unused bar codes on this and the facing page to ensure the scanner reads only the bar code you intend to scan.
3. Scan the appropriate digits from the keypad in *Appendix C* that represent the desired Label ID characters; entered as two hex pairs. A table containing the *ASCII Character Set* and their corresponding Hex Values is available in the inside back cover of this manual. ASCII parameters must be input by scanning a pair of hexadecimal digits for each character. Thus, to set a two-character value of AB, bar codes containing the digits '4', '1', '4', and '2' must be scanned. The selectable range for this option is any hex value from 00 to FF.
4. Complete the programming sequence by scanning the SWITCH bar code.

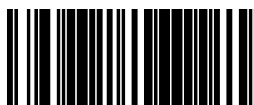

SET EAN-8 2-DIGIT SUPPLEMENTAL LABEL ID

EAN-8 5-Digit Supplemental Label ID

This feature specifies an EAN-8 5-Digit Supplemental label ID to be added to bar code data.



NOTE

The programming feature, ***RS-232 Label ID Control***, designates whether the Label ID is transmitted as a prefix or suffix or if Label ID is disabled.

To set this feature:

1. Scan the SWITCH bar code.
2. Scan the bar code, *SET EAN-8 5-DIGIT SUPPLEMENTAL LABEL ID* below. You'll need to cover any unused bar codes on this and the facing page to ensure the scanner reads only the bar code you intend to scan.
3. Scan the appropriate digits from the keypad in *Appendix C* that represent the desired Label ID characters; entered as two hex pairs. A table containing the *ASCII Character Set* and their corresponding Hex Values is available in the inside back cover of this manual. ASCII parameters must be input by scanning a pair of hexadecimal digits for each character. Thus, to set a two-character value of AB, bar codes containing the digits '4', '1', '4', and '2' must be scanned. The selectable range for this option is any hex value from 00 to FF.
4. Complete the programming sequence by scanning the SWITCH bar code.



SET EAN-8 5-DIGIT SUPPLEMENTAL LABEL ID

EAN-8 128 Supplemental Label ID

This feature specifies an EAN-8 128 Supplemental label ID to be added to bar code data.



NOTE

The programming feature, *RS-232 Label ID Control*, designates whether the Label ID is transmitted as a prefix or suffix or if Label ID is disabled.

To set this feature:

1. Scan the SWITCH bar code.
2. Scan the bar code, *SET EAN-8 128 SUPPLEMENTAL LABEL ID* below. You'll need to cover any unused bar codes on this and the facing page to ensure the scanner reads only the bar code you intend to scan.
3. Scan the appropriate digits from the keypad in *Appendix C* that represent the desired Label ID characters; entered as two hex pairs. A table containing the *ASCII Character Set* and their corresponding Hex Values is available in the inside back cover of this manual. ASCII parameters must be input by scanning a pair of hexadecimal digits for each character. Thus, to set a two-character value of AB, bar codes containing the digits '4', '1', '4', and '2' must be scanned. The selectable range for this option is any hex value from 00 to FF.
4. Complete the programming sequence by scanning the SWITCH bar code.



SET EAN-8 128 SUPPLEMENTAL LABEL ID

EAN-8 Decoding Levels

Decoding levels allow the decoder to be set to perform at one of four selectable levels:

- Very Conservative — Slower scan time, however, allows few, if any, misreads. The most secure setting.
- Slightly More Aggressive — Faster scanning, less security.
- Moderately Aggressive — Even faster scanning, but even less security.
- Very Aggressive — Fastest scan speed, but will increase the potential for misreads. The least secure setting.



CAUTION

Use caution when setting this feature, as the aggressive settings for this feature allow a higher potential for misreads.

To set this feature:

1. Scan the SWITCH bar code.
2. Scan the bar code representing the desired option on the following pages. You'll need to cover any unused bar codes on facing pages to ensure that the scanner reads only the bar code you intend to scan.
3. Complete the programming sequence by scanning the SWITCH bar code.



NOTE

It is important to note that the default for this feature is the “VERY CONSERVATIVE” setting. For default settings for other features, see *Appendix E*.

EAN-8 Decoding Levels — continued

Remember to cover any unused bar codes on this and the facing page to ensure that the scanner reads only the bar code you intend to scan.



EAN-8 DECODING LEVELS = VERY CONSERVATIVE



EAN-8 DECODING LEVELS = SLIGHTLY MORE AGGRESSIVE

EAN-8 Decoding Levels — continued

Remember to cover any unused bar codes on this and the facing page to ensure that the scanner reads only the bar code you intend to scan.



EAN-8 DECODING LEVELS = MODERATELY AGGRESSIVE



EAN-8 DECODING LEVELS = VERY AGGRESSIVE

Other UPC/EAN Options

The following pages contain other selectable features for UPC/EAN symbologies:

- UPC/EAN Reconstruction
- Price Weight Check
- Enable EAN Two Label
- Addons
- UPC-A and EAN-13 Decoding Levels

UPC/EAN Reconstruction

Enables/disables the ability of the scanner to decode a class of UPC/EAN labels with voids. The label voids may be caused by printing defects or physical damage. This feature may be helpful in environments with in-store printed labels.



CAUTION

Enabling this feature increases the potential of misreads.

To set this feature:

1. Scan the SWITCH bar code.
2. Scan either the enable or disable bar code below. You'll need to cover any unused bar codes on this and the facing page to ensure that the scanner reads only the bar code you intend to scan.

Complete the programming sequence by scanning the SWITCH bar code.



UPC/EAN RECONSTRUCTION = DISABLE



UPC/EAN RECONSTRUCTION = ENABLE

Price Weight Check

Enables/disables calculation and verification of price/weight check digits. Applies to all UPC-A and EAN/JAN-13 labels with eligible¹ Number System/First Character digits.

Options are:

- Disable
- 4-digit price/weight
- 5-digit price/weight
- 4-digit European price/weight
- 5-digit European price/weight

To set this feature:

1. Scan the SWITCH bar code.
2. Scan the bar code representing the desired option below or on the following pages. You'll need to cover any unused bar codes on facing pages to ensure that the scanner reads only the bar code you intend to scan.
3. Complete the programming sequence by scanning the SWITCH bar code.



PRICE WEIGHT CHECK = DISABLE

1. Price Weight Check generally applies to UPC-A labels with a Number System Digit of 2 and EAN/JAN-13 labels with a First Character of 2. There are a total of six flag digits corresponding to the six types. Checking applies depending upon which type is enabled.

Price Weight Check — continued

Remember to cover any unused bar codes on this and the facing page to ensure that the scanner reads only the bar code you intend to scan.



PRICE WEIGHT CHECK = 4-DIGIT PRICE/WEIGHT



PRICE WEIGHT CHECK = 5-DIGIT PRICE/WEIGHT

Price Weight Check — continued

Remember to cover any unused bar codes on this and the facing page to ensure that the scanner reads only the bar code you intend to scan.

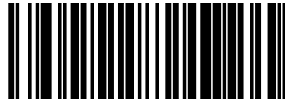

PRICE WEIGHT CHECK = 4-DIGIT EUROPEAN PRICE/WEIGHT



PRICE WEIGHT CHECK = 5-DIGIT EUROPEAN PRICE/WEIGHT

Enable EAN Two Label

Enables/disables the ability of the scanner to decode EAN two-label pairs.

To set this feature:

1. Scan the SWITCH bar code.
2. Scan either the enable or disable bar code below. You'll need to cover any unused bar codes on this and the facing page to ensure that the scanner reads only the bar code you intend to scan.
3. Complete the programming sequence by scanning the SWITCH bar code.



Contact Customer Support for details about advanced programming for this feature.



EAN TWO LABEL = DISABLE



EAN TWO LABEL = ENABLE

Addons

The scanner is capable of processing different types of add-on codes, including:

- 2-Digit Supplemental
- 5-Digit Supplemental

Options are provided on the following pages for your convenience:

- Disable all addons — The scanner will not look for or read addons.
- Optional 2-Digit and 5-Digit Supplemental — Bar codes can be read which include 2-Digit or 5-Digit Supplementals, however, it is not required that addons be included in bar codes.



Contact customer support for advanced programming of optional and conditional addons.

To set this feature:

1. Scan the SWITCH bar code.
2. Scan the bar code representing the desired option on this and the following page. You'll need to cover any unused bar codes on facing pages to ensure that the scanner reads only the bar code you intend to scan.
3. Complete the programming sequence by scanning the SWITCH bar code.



ADDONS = DISABLE

Addons — continued

Remember to cover any unused bar codes on this and the facing page to ensure that the scanner reads only the bar code you intend to scan.

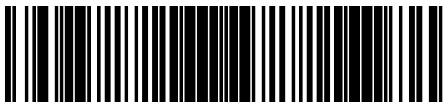

ADDONS = OPTIONAL 2-DIGIT AND 5-DIGIT SUPPLEMENTAL

UPC-A and EAN-13 Decoding Levels

Decoding levels allow the decoder to be set to perform at one of four selectable levels:

- Very Conservative — Slower scan time, however, allows few, if any, misreads. The most secure setting.
- Slightly More Aggressive — Faster scanning, less security.
- Moderately Aggressive — Even faster scanning, but even less security.
- Very Aggressive — Fastest scan speed, but will increase the potential for misreads. The least secure setting.



CAUTION

Use caution when setting this feature, as the aggressive settings for this feature allow a higher potential for misreads.

To set this feature:

1. Scan the SWITCH bar code.
2. Scan the bar code representing the desired option on the following pages. You'll need to cover any unused bar codes on facing pages to ensure that the scanner reads only the bar code you intend to scan.
3. Complete the programming sequence by scanning the SWITCH bar code.



NOTE

It is important to note that the default for this feature is the “SLIGHTLY MORE AGGRESSIVE” setting. For default settings for other features, see *Appendix E*.

UPC-A and EAN-13 Decoding Levels — continued

Remember to cover any unused bar codes on this and the facing page to ensure that the scanner reads only the bar code you intend to scan.



UPC-A/EAN-13 DECODING LEVELS = VERY CONSERVATIVE



UPC-A/EAN-13 DECODING LEVELS = SLIGHTLY MORE AGGRESSIVE

UPC-A and EAN-13 Decoding Levels — continued

Remember to cover any unused bar codes on this and the facing page to ensure that the scanner reads only the bar code you intend to scan.



UPC-A/EAN-13 DECODING LEVELS = MODERATELY AGGRESSIVE



UPC-A/EAN-13 DECODING LEVELS = VERY AGGRESSIVE

GTIN Enable

Enables/Disables the ability to convert UPCE, UPCA, EAN8, and EAN13 labels into the GTIN 14-character format.



NOTE

If add-on information is present on the base label prior to the conversion taking place, the add-on information will be appended to the converted GTIN bar code.

To set this feature:

1. Scan the SWITCH bar code.
2. Scan either the enable or disable bar code below. You'll need to cover any unused bar codes on this and the facing page to ensure that the scanner reads only the bar code you intend to scan.
3. Complete the programming sequence by scanning the SWITCH bar code.

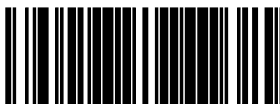

GTIN = DISABLE

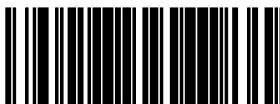

GTIN = ENABLE

GTIN Label ID

This feature specifies a GTIN label ID to be added to bar code data when GTIN conversion is enabled.



NOTE

The programming feature, ***RS-232 Label ID Control***, designates whether the Label ID is transmitted as a prefix or suffix or if Label ID is disabled.

To set this feature:

1. Scan the SWITCH bar code.
2. Scan the bar code, *SET GTIN LABEL ID* below. You'll need to cover any unused bar codes on this and the facing page to ensure the scanner reads only the bar code you intend to scan.
3. Scan the appropriate digits from the keypad in *Appendix C* that represent the desired Label ID characters; entered as two hex pairs. A table containing the *ASCII Character Set* and their corresponding Hex Values is available in the inside back cover of this manual. ASCII parameters must be input by scanning a pair of hexadecimal digits for each character. Thus, to set a two-character value of AB, bar codes containing the digits '4', '1', '4', and '2' must be scanned. The selectable range for this option is any hex value from 00 to FF (for each of the two characters).
4. Complete the programming sequence by scanning the SWITCH bar code.

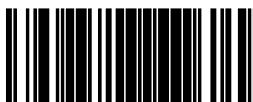

SET GTIN LABEL ID

GTIN 2-Digit Supplemental Label ID

This feature specifies a GTIN label ID to be added to bar code data when GTIN conversion is enabled and 2-digit supplemental add-on bar code labels are converted.



NOTE

The programming feature, ***RS-232 Label ID Control***, designates whether the Label ID is transmitted as a prefix or suffix or if Label ID is disabled.

To set this feature:

1. Scan the SWITCH bar code.
2. Scan the bar code, *SET GTIN 2-DIGIT SUPPLEMENTAL LABEL ID* below. You'll need to cover any unused bar codes on this and the facing page to ensure the scanner reads only the bar code you intend to scan.
3. Scan the appropriate digits from the keypad in *Appendix C* that represent the desired Label ID characters; entered as two hex pairs. A table containing the *ASCII Character Set* and their corresponding Hex Values is available in the inside back cover of this manual. ASCII parameters must be input by scanning a pair of hexadecimal digits for each character. Thus, to set a two-character value of AB, bar codes containing the digits '4', '1', '4', and '2' must be scanned. The selectable range for this option is any hex value from 00 to FF (for each of the two characters).
4. Complete the programming sequence by scanning the SWITCH bar code.

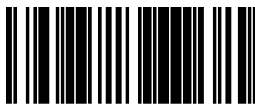

SET GTIN 2-DIGIT SUPPLEMENTAL LABEL ID

GTIN 5-Digit Supplemental Label ID

This feature specifies a GTIN label ID to be added to bar code data when GTIN conversion is enabled and 5-digit supplemental add-on bar code labels are converted.



NOTE

The programming feature, ***RS-232 Label ID Control***, designates whether the Label ID is transmitted as a prefix or suffix or if Label ID is disabled.

To set this feature:

1. Scan the SWITCH bar code.
2. Scan the bar code, *SET GTIN 5-DIGIT SUPPLEMENTAL LABEL ID* below. You'll need to cover any unused bar codes on this and the facing page to ensure the scanner reads only the bar code you intend to scan.
3. Scan the appropriate digits from the keypad in *Appendix C* that represent the desired Label ID characters; entered as two hex pairs. A table containing the *ASCII Character Set* and their corresponding Hex Values is available in the inside back cover of this manual. ASCII parameters must be input by scanning a pair of hexadecimal digits for each character. Thus, to set a two-character value of AB, bar codes containing the digits '4', '1', '4', and '2' must be scanned. The selectable range for this option is any hex value from 00 to FF (for each of the two characters).
4. Complete the programming sequence by scanning the SWITCH bar code.

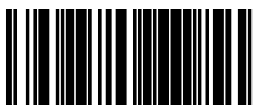

SET GTIN 5-DIGIT SUPPLEMENTAL LABEL ID

GTIN Code 128 Supplemental Label ID

This feature specifies a GTIN label ID to be added to bar code data when GTIN conversion is enabled and Code 128 supplemental add-on bar code labels are converted



NOTE

The programming feature, *RS-232 Label ID Control*, designates whether the Label ID is transmitted as a prefix or suffix or if Label ID is disabled.

To set this feature:

1. Scan the SWITCH bar code.
2. Scan the bar code, *SET GTIN CODE 128 SUPPLEMENTAL LABEL ID* below. You'll need to cover any unused bar codes on this and the facing page to ensure the scanner reads only the bar code you intend to scan.
3. Scan the appropriate digits from the keypad in *Appendix C* that represent the desired Label ID characters; entered as two hex pairs. A table containing the *ASCII Character Set* and their corresponding Hex Values is available in the inside back cover of this manual. ASCII parameters must be input by scanning a pair of hexadecimal digits for each character. Thus, to set a two-character value of AB, bar codes containing the digits '4', '1', '4', and '2' must be scanned. The selectable range for this option is any hex value from 00 to FF (for each of the two characters).
4. Complete the programming sequence by scanning the SWITCH bar code.



SET GTIN CODE 128 SUPPLEMENTAL LABEL ID

RSS-14 Enable

Enables/disables the ability of the scanner to decode RSS-14 labels.



NOTE

This value-added feature is a factory-programmed option. Contact your dealer for information about upgrading your system to include this advanced capability.

To set this feature:

1. Scan the SWITCH bar code.
2. Scan either the enable or disable bar code below. You'll need to cover any unused bar codes on this and the facing page to ensure that the scanner reads only the bar code you intend to scan.
3. Complete the programming sequence by scanning the SWITCH bar code.



RSS-14 = DISABLE



RSS-14 = ENABLE

RSS-14 Check Character Transmission

Enables/disables transmission of the RSS-14 check character.

To set this feature:

1. Scan the SWITCH bar code.
2. Scan either the enable or disable bar code below. You'll need to cover any unused bar codes on this and the facing page to ensure that the scanner reads only the bar code you intend to scan.
3. Complete the programming sequence by scanning the SWITCH bar code.

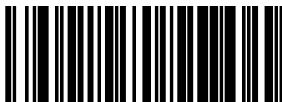

RSS-14 CHECK CHARACTER TRANSMISSION = DISABLE



RSS-14 CHECK CHARACTER TRANSMISSION = ENABLE

RSS-14/EAN-128 Emulation

Enables/disables the ability of RSS-14 to be transmitted as EAN-128.

To set this feature:

1. Scan the SWITCH bar code.
2. Scan either the enable or disable bar code below. You'll need to cover any unused bar codes on this and the facing page to ensure that the scanner reads only the bar code you intend to scan.
3. Complete the programming sequence by scanning the SWITCH bar code.

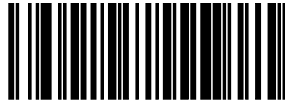

RSS-14/EAN-128 EMULATION = DISABLE



RSS-14/EAN-128 EMULATION = ENABLE

RSS-14 2D Component Enable

When this feature is enabled, and the software reads an RSS-14 bar code that has a 2D component associated with it, the RSS-14 bar code will not be reported to the terminal.

To set this feature:

1. Scan the SWITCH bar code.
2. Scan your selection from the bar codes below. You'll need to cover any unused bar codes on this and the facing page to ensure that the scanner reads only the bar code you intend to scan.
3. Complete the programming sequence by scanning the SWITCH bar code.



RSS-14 2D COMPONENT = DISABLE

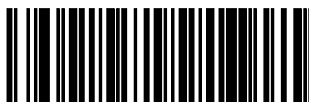

RSS-14 2D COMPONENT = ENABLE

RSS-14 AIM ID

This feature enables/disables transmission of the RSS-14 AIM symbology identifier.

To set this feature:

1. Scan the SWITCH bar code.
2. Scan your selection from the bar codes below. You'll need to cover any unused bar codes on this and the facing page to ensure that the scanner reads only the bar code you intend to scan.
3. Complete the programming sequence by scanning the SWITCH bar code.

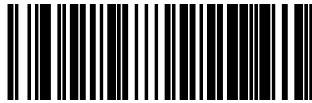

RSS-14 AIM ID = DISABLE



RSS-14 AIM ID = ENABLE

RSS-14 Label ID

This feature specifies an RSS-14 label ID to be added to bar code data.

To set this feature:



NOTE

The programming feature, ***RS-232 Label ID Control***, designates whether the Label ID is transmitted as a prefix or suffix or if Label ID is disabled.

To set this feature:

1. Scan the SWITCH bar code.
2. Scan the bar code, *SET RSS-14 LABEL ID* below. You'll need to cover any unused bar codes on this and the facing page to ensure the scanner reads only the bar code you intend to scan.
3. Scan the appropriate digits from the keypad in *Appendix C* that represent the desired Label ID characters; entered as two hex pairs. A table containing the *ASCII Character Set* and their corresponding Hex Values is available in the inside back cover of this manual. ASCII parameters must be input by scanning a pair of hexadecimal digits for each character. Thus, to set a two-character value of AB, bar codes containing the digits '4', '1', '4', and '2' must be scanned. The selectable range for this option is any hex value from 00 to FF.
4. Complete the programming sequence by scanning the SWITCH bar code.



SET RSS-14 LABEL ID

RSS Expanded Enable

Enables/disables the ability of the scanner to decode RSS-Expanded labels.



NOTE

This value-added feature is a factory-programmed option. Contact your dealer for information about upgrading your system to include this advanced capability.

To set this feature:

1. Scan the SWITCH bar code.
2. Scan either the enable or disable bar code below. You'll need to cover any unused bar codes on this and the facing page to ensure that the scanner reads only the bar code you intend to scan.
3. Complete the programming sequence by scanning the SWITCH bar code.



RSS-EXPANDED = DISABLE



RSS-EXPANDED = ENABLE

RSS Expanded EAN-128 Emulation

Enables/disables EAN 128 emulation for RSS Expanded.

To set this feature:

1. Scan the SWITCH bar code.
2. Scan either the enable or disable bar code below. You'll need to cover any unused bar codes on this and the facing page to ensure that the scanner reads only the bar code you intend to scan.
3. Complete the programming sequence by scanning the SWITCH bar code.



RSS EXPANDED/EAN-128 EMULATION = DISABLE



RSS EXPANDED/EAN-128 EMULATION = ENABLE

RSS Expanded 2D Component Enable

When this feature is enabled, and the software reads an RSS Expanded bar code that has a 2D component associated with it, the RSS Expanded bar code will not be reported to the terminal.

To set this feature:

1. Scan the SWITCH bar code.
2. Scan your selection from the bar codes below. You'll need to cover any unused bar codes on this and the facing page to ensure that the scanner reads only the bar code you intend to scan.
3. Complete the programming sequence by scanning the SWITCH bar code.

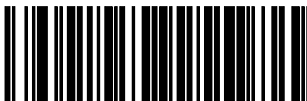

RSS EXPANDED 2D COMPONENT = DISABLE



RSS EXPANDED 2D COMPONENT = ENABLE

RSS Expanded AIM ID

This feature enables/disables transmission of the RSS Expanded AIM symbology identifier.

To set this feature:

1. Scan the SWITCH bar code.
2. Scan your selection from the bar codes below. You'll need to cover any unused bar codes on this and the facing page to ensure that the scanner reads only the bar code you intend to scan.
3. Complete the programming sequence by scanning the SWITCH bar code.

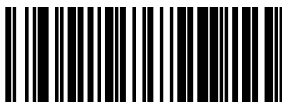

RSS EXPANDED AIM ID = DISABLE



RSS EXPANDED AIM ID = ENABLE

RSS Expanded Label ID

This feature specifies an RSS Expanded label ID to be added to bar code data.



NOTE

The programming feature, *RS-232 Label ID Control*, designates whether the Label ID is transmitted as a prefix or suffix or if Label ID is disabled.

To set this feature:

1. Scan the SWITCH bar code.
2. Scan the bar code, *SET RSS EXPANDED LABEL ID* below. You'll need to cover any unused bar codes on this and the facing page to ensure the scanner reads only the bar code you intend to scan.
3. Scan the appropriate digits from the keypad in *Appendix C* that represent the desired Label ID characters; entered as two hex pairs. A table containing the *ASCII Character Set* and their corresponding Hex Values is available in the inside back cover of this manual. ASCII parameters must be input by scanning a pair of hexadecimal digits for each character. Thus, to set a two-character value of AB, bar codes containing the digits '4', '1', '4', and '2' must be scanned. The selectable range for this option is any hex value from 00 to FF.
4. Complete the programming sequence by scanning the SWITCH bar code.



SET RSS EXPANDED LABEL ID

RSS Expanded Length Control

This feature specifies either variable-length or fixed-length decoding for RSS Expanded.

To set this feature:

1. Scan the SWITCH bar code.
2. Scan your selection from the bar codes below. You'll need to cover any unused bar codes on this and the facing page to ensure that the scanner reads only the bar code you intend to scan.
3. Complete the programming sequence by scanning the SWITCH bar code.



NOTE

If variable-length control was selected, you must now set the features ***RSS Expanded Maximum Label Length*** and ***RSS Expanded Minimum Label Length***. If fixed-length control was selected, you must now set ***RSS Expanded Fixed Length 1*** and ***RSS Expanded Fixed Length 2***.



RSS EXPANDED LENGTH CONTROL = VARIABLE-LENGTH



RSS EXPANDED LENGTH CONTROL = FIXED-LENGTH

RSS Expanded Maximum Label Length

This feature specifies the maximum allowable length of an RSS Expanded label.



NOTE

Length in this case includes check and data characters. This applies when *RSS Expanded Length Control* is set to variable-length decoding.

Maximum Label Length should be greater than or equal to Minimum Label Length.

To set this feature:

1. Scan the SWITCH bar code.
2. Scan the bar code, *SET RSS EXPANDED MAXIMUM LABEL LENGTH* below. You'll need to cover any unused bar codes on this and the facing page to ensure that the scanner reads only the bar code you intend to scan.
3. Scan the appropriate digits from the keypad in *Appendix C* that represent the desired maximum label length. The selectable range for this option is 00 to 74. Pad all single digit numbers with a leading zero to yield a two-digit entry (00-74).
4. Complete the programming sequence by scanning the SWITCH bar code.



SET RSS EXPANDED MAXIMUM LABEL LENGTH

RSS Expanded Minimum Label Length

This feature specifies the minimum allowable length of an RSS Expanded label.



NOTE

Length in this case includes check and data characters. This applies when *RSS Expanded Length Control* is set to variable-length decoding.

Minimum Label Length should be less than or equal to Maximum Label Length.

To set this feature:

1. Scan the SWITCH bar code.
2. Scan the bar code, *SET RSS EXPANDED MINIMUM LABEL LENGTH* below. You'll need to cover any unused bar codes on this and the facing page to ensure that the scanner reads only the bar code you intend to scan.
3. Scan the appropriate digits from the keypad in *Appendix C* that represent the desired minimum label length. The selectable range for this option is 00 to 74. Pad all single digit numbers with a leading zero to yield a two-digit entry (00-74).
4. Complete the programming sequence by scanning the SWITCH bar code.

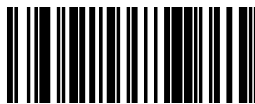

SET RSS EXPANDED MINIMUM LABEL LENGTH

RSS Expanded Fixed Length 1

This feature specifies RSS Expanded first fixed length.



NOTE

This applies when *RSS Expanded Length Control* is set to fixed-length decoding.

To set this feature:

1. Scan the SWITCH bar code.
2. Scan the bar code, *SET RSS EXPANDED FIXED LENGTH 1* below. You'll need to cover any unused bar codes on this and the facing page to ensure that the scanner reads only the bar code you intend to scan.
3. Scan the appropriate digits from the keypad in *Appendix C* that represent the desired fixed label length. The selectable range for this option is 00 to 74. Pad all single digit numbers with a leading zero to yield a two-digit entry (00-74).
4. Complete the programming sequence by scanning the SWITCH bar code.



SET RSS EXPANDED FIXED LENGTH 1

RSS Expanded Fixed Length 2

This feature specifies RSS Expanded second fixed length.



NOTE

This applies when ***RSS Expanded Length Control*** is set to fixed-length decoding.

If **Fixed Length 2** is set to 00 (zero), then **Fixed Length 1** will apply.

To set this feature:

1. Scan the SWITCH bar code.
2. Scan the bar code, *SET RSS EXPANDED FIXED LENGTH 2* below. You'll need to cover any unused bar codes on this and the facing page to ensure that the scanner reads only the bar code you intend to scan.
3. Scan the appropriate digits from the keypad in *Appendix C* that represent the desired fixed label length. The selectable range for this option is 00 to 74. Pad all single digit numbers with a leading zero to yield a two-digit entry (00-74).
4. Complete the programming sequence by scanning the SWITCH bar code.



SET RSS EXPANDED FIXED LENGTH 2

Code 39 Enable

Enables/disables the ability of the scanner to decode Code 39 labels.

To set this feature:

1. Scan the SWITCH bar code.
2. Scan either the enable or disable bar code below. You'll need to cover any unused bar codes on this and the facing page to ensure that the scanner reads only the bar code you intend to scan.
3. Complete the programming sequence by scanning the SWITCH bar code.

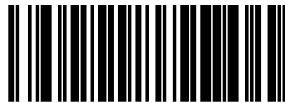

CODE 39 = DISABLE



CODE 39 = ENABLE

Code 39 Start Stop Character Transmission

Enables/disables transmission of Code 39 start and stop characters.

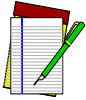

NOTE

This item is ignored when the advanced feature, Full Label Edit, is enabled.

To set this feature:

1. Scan the SWITCH bar code.
2. Scan either the enable or disable bar code below. You'll need to cover any unused bar codes on this and the facing page to ensure that the scanner reads only the bar code you intend to scan.
3. Complete the programming sequence by scanning the SWITCH bar code.

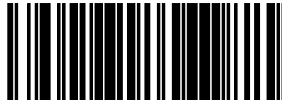

CODE 39 START STOP CHARACTER TRANSMISSION = DISABLE

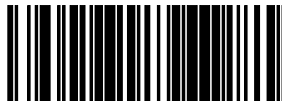

CODE 39 START STOP CHARACTER TRANSMISSION = ENABLE

Code 39 Check Character Calculation

Enables/disables calculation and verification of an optional Code 39 check character. When disabled, any check character in label is treated as a data character.



NOTE

If check calculation is disabled, the risk is increased that a misread can occur.

In particular, if you are using variable length stitching, it is important to use check character calculation to prevent misreads.

To set this feature:

1. Scan the SWITCH bar code.
2. Scan either the enable or disable bar code below. You'll need to cover any unused bar codes on this and the facing page to ensure that the scanner reads only the bar code you intend to scan.
3. Complete the programming sequence by scanning the SWITCH bar code.



CODE 39 CHECK CHARACTER CALCULATION = DISABLE



CODE 39 CHECK CHARACTER CALCULATION = ENABLE

Code 39 Check Character Transmission

Enables/disables transmission of optional Code 39 check character.



NOTE

This item is ignored when the advanced feature, Full Label Edit, is enabled.

To set this feature:

1. Scan the SWITCH bar code.
2. Scan either the enable or disable bar code below. You'll need to cover any unused bar codes on this and the facing page to ensure that the scanner reads only the bar code you intend to scan.
3. Complete the programming sequence by scanning the SWITCH bar code.



CODE 39 CHECK CHARACTER TRANSMISSION = DISABLE



CODE 39 CHECK CHARACTER TRANSMISSION = ENABLE

Code 39 Full ASCII

Enables/disables the ability of the scanner to translate to Code 39 full ASCII labels.

To set this feature:

1. Scan the SWITCH bar code.
2. Scan either the enable or disable bar code below. You'll need to cover any unused bar codes on this and the facing page to ensure that the scanner reads only the bar code you intend to scan.
3. Complete the programming sequence by scanning the SWITCH bar code.



CODE 39 FULL ASCII = DISABLE



CODE 39 FULL ASCII = ENABLE

Code 39 AIM ID

This feature enables/disables transmission of the Code 39 AIM symbology identifier.

To set this feature:

1. Scan the SWITCH bar code.
2. Scan your selection from the bar codes below. You'll need to cover any unused bar codes on this and the facing page to ensure that the scanner reads only the bar code you intend to scan.
3. Complete the programming sequence by scanning the SWITCH bar code.



CODE 39 AIM ID = DISABLE



CODE 39 AIM ID = ENABLE

Code 39 Label ID

This feature specifies a Code 39 label ID to be added to bar code data.



NOTE

The programming feature, ***RS-232 Label ID Control***, designates whether the Label ID is transmitted as a prefix or suffix or if Label ID is disabled.

To set this feature:

1. Scan the SWITCH bar code.
2. Scan the bar code, *SET CODE 39 LABEL ID* below. You'll need to cover any unused bar codes on this and the facing page to ensure the scanner reads only the bar code you intend to scan.
3. Scan the appropriate digits from the keypad in *Appendix C* that represent the desired Label ID characters; entered as two hex pairs. A table containing the *ASCII Character Set* and their corresponding Hex Values is available in the inside back cover of this manual. ASCII parameters must be input by scanning a pair of hexadecimal digits for each character. Thus, to set a two-character value of AB, bar codes containing the digits '4', '1', '4', and '2' must be scanned. The selectable range for this option is any hex value from 00 to FF.
4. Complete the programming sequence by scanning the SWITCH bar code.

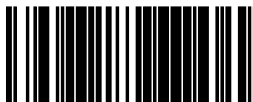

SET CODE 39 LABEL ID

Code 39 Length Control

This feature specifies whether variable-length or fixed-length decoding will be set for Code 39.

To set this feature:

1. Scan the SWITCH bar code.
2. Scan your selection from the bar codes below. You'll need to cover any unused bar codes on this and the facing page to ensure that the scanner reads only the bar code you intend to scan.
3. Complete the programming sequence by scanning the SWITCH bar code.



NOTE

If variable-length control was selected, you must now set the features **Code 39 Maximum Label Length** and **Code 39 Minimum Label Length**. If fixed-length control was selected, you must now set **Code 39 Fixed Length 1** and **Code 39 Fixed Length 2**.

When using variable length stitching, it is important to enable **Code 39 Check Character Calculation** to prevent misreads.



CODE 39 LENGTH CONTROL = VARIABLE-LENGTH



CODE 39 LENGTH CONTROL = FIXED-LENGTH

Code 39 Maximum Label Length

This feature specifies the maximum allowable length of a Code 39 label.



NOTE

Length in this case includes check, data and ASCII characters, but does not include start, or stop characters. This feature applies when *Code 39 Length Control* is set to variable-length decoding.

Maximum label length should be greater than or equal to minimum label length.

To set this feature:

1. Scan the SWITCH bar code.
2. Scan the bar code, *SET CODE 39 MAXIMUM LABEL LENGTH* below. You'll need to cover any unused bar codes on this and the facing page to ensure that the scanner reads only the bar code you intend to scan.
3. Scan the appropriate digits from the keypad in *Appendix C* that represent the desired maximum label length. The selectable range for this option is 00 to 50. Pad all single digit numbers with a leading zero to yield a two-digit entry (00-50).
4. Complete the programming sequence by scanning the SWITCH bar code.



SET CODE 39 MAXIMUM LABEL LENGTH

Code 39 Minimum Label Length

This feature specifies the minimum allowable length of a Code 39 label.



NOTE

Length in this case includes check, data and ASCII characters, but does not include start, or stop characters. This feature applies when **Code 39 Length Control** is set to variable-length decoding.

Minimum label length should be less than or equal to maximum label length.

To set this feature:

1. Scan the SWITCH bar code.
2. Scan the bar code, *SET CODE 39 MINIMUM LABEL LENGTH* below. You'll need to cover any unused bar codes on this and the facing page to ensure that the scanner reads only the bar code you intend to scan.
3. Scan the appropriate digits from the keypad in *Appendix C* that represent the desired minimum label length. The selectable range for this option is 00 to 50. Pad all single digit numbers with a leading zero to yield a two-digit entry (00-50).
4. Complete the programming sequence by scanning the SWITCH bar code.



SET CODE 39 MINIMUM LABEL LENGTH

Code 39 Fixed Length 1

This feature specifies Code 39 first fixed length.



NOTE

This applies when *Code 39 Length Control* is set to fixed-length decoding.

The minimum decodable length is four when an optional check character is present.

To set this feature:

1. Scan the SWITCH bar code.
2. Scan the bar code, *SET CODE 39 FIXED LENGTH 1* below. You'll need to cover any unused bar codes on this and the facing page to ensure that the scanner reads only the bar code you intend to scan.
3. Scan the appropriate digits from the keypad in *Appendix C* that represent the desired fixed label length. The selectable range for this option is 00 to 50. Pad all single digit numbers with a leading zero to yield a two-digit entry (00-50).
4. Complete the programming sequence by scanning the SWITCH bar code.

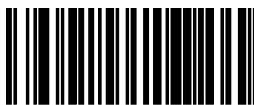

SET CODE 39 FIXED LENGTH 1

Code 39 Fixed Length 2

This feature specifies Code 39 second fixed length.

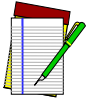

NOTE

This applies when **Code 39 Length Control** is set to fixed-length decoding.

If Fixed Length 2 is set to 00, then Fixed Length 1 will apply

To set this feature:

1. Scan the SWITCH bar code.
2. Scan the bar code, *SET CODE 39 FIXED LENGTH 2* below. You'll need to cover any unused bar codes on this and the facing page to ensure that the scanner reads only the bar code you intend to scan.
3. Scan the appropriate digits from the keypad in *Appendix C* that represent the desired fixed label length. The selectable range for this option is 00, no second fixed length, or 01 to 50. Pad all single digit numbers with a leading zero to yield a two-digit entry (00-50).
4. Complete the programming sequence by scanning the SWITCH bar code.



SET CODE 39 FIXED LENGTH 2

Code 39 Stitching

Enables/disables stitching for Code 39 labels. When parts of a Code 39 bar code are presented to the scanner with this feature enabled, the bar code parts will be assembled by the scanner's software, and the data will be decoded if all bar code proofing requirements are met.

To set this feature:

1. Scan the SWITCH bar code.
2. Scan your selection from the bar codes below. You'll need to cover any unused bar codes on this and the facing page to ensure that the scanner reads only the bar code you intend to scan.

Complete the programming sequence by scanning the SWITCH bar code.



CODE 39 STITCHING = DISABLE



CODE 39 STITCHING = ENABLE

Pharmacode 39 Enable

Enables/disables the ability of the scanner to decode Italian Pharmacode 39 labels.

To set this feature:

1. Scan the SWITCH bar code.
2. Scan either the enable or disable bar code below. You'll need to cover any unused bar codes on this and the facing page to ensure that the scanner reads only the bar code you intend to scan.
3. Complete the programming sequence by scanning the SWITCH bar code.



PHARMACODE 39 = DISABLE



PHARMACODE 39 = ENABLE

Pharmacode 39 Start Stop Character Transmission

Enables/ disables transmission of start and stop characters for Pharmacode 39.



NOTE

This item is ignored when the advanced feature, Full Label Edit, is enabled.

To set this feature:

1. Scan the SWITCH bar code.
2. Scan either the enable or disable bar code below. You'll need to cover any unused bar codes on this and the facing page to ensure that the scanner reads only the bar code you intend to scan.
3. Complete the programming sequence by scanning the SWITCH bar code.



PHARMACODE 39 START STOP CHARACTER TRANSMISSION = DISABLE



PHARMACODE 39 START STOP CHARACTER TRANSMISSION = ENABLE

Pharmacode 39 Check Character Transmission

Enables/disables transmission of Pharmacode 39 check character.



NOTE

This item is ignored when the advanced feature, Full Label Edit, is enabled.

To set this feature:

1. Scan the SWITCH bar code.
2. Scan either the enable or disable bar code below. You'll need to cover any unused bar codes on this and the facing page to ensure that the scanner reads only the bar code you intend to scan.
3. Complete the programming sequence by scanning the SWITCH bar code.



PHARMACODE 39 CHECK CHARACTER TRANSMISSION = DISABLE

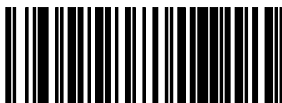

PHARMACODE 39 CHECK CHARACTER TRANSMISSION = ENABLE

Pharmacode 39 Label ID

This feature specifies a Pharmacode 39 label ID to be added to bar code data.



NOTE

The programming feature, *RS-232 Label ID Control*, designates whether the Label ID is transmitted as a prefix or suffix or if Label ID is disabled.

To set this feature:

1. Scan the SWITCH bar code.
2. Scan the bar code, *SET PHARMACODE 39 LABEL ID* below. You'll need to cover any unused bar codes on this and the facing page to ensure the scanner reads only the bar code you intend to scan.
3. Scan the appropriate digits from the keypad in *Appendix C* that represent the desired Label ID characters; entered as two hex pairs. A table containing the *ASCII Character Set* and their corresponding Hex Values is available in the inside back cover of this manual. ASCII parameters must be input by scanning a pair of hexadecimal digits for each character. Thus, to set a two-character value of AB, bar codes containing the digits '4', '1', '4', and '2' must be scanned. The selectable range for this option is any hex value from 00 to FF.
4. Complete the programming sequence by scanning the SWITCH bar code.



SET PHARMACODE 39 LABEL ID

Code 128 Enable

Enables/disables the ability of the scanner to decode Code 128 labels.

To set this feature:

1. Scan the SWITCH bar code.
2. Scan either the enable or disable bar code below. You'll need to cover any unused bar codes on this and the facing page to ensure that the scanner reads only the bar code you intend to scan.
3. Complete the programming sequence by scanning the SWITCH bar code.



CODE 128 = DISABLE



CODE 128 = ENABLE

Code 128 Transmit Function Characters

Enables/disables transmission of Code 128 function characters 1, 2, 3, and 4.

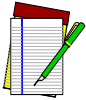

NOTE

Disabled is the recommended setting for all interfaces.

To set this feature:

1. Scan the SWITCH bar code.
2. Scan either the enable or disable bar code below. You'll need to cover any unused bar codes on this and the facing page to ensure that the scanner reads only the bar code you intend to scan.
3. Complete the programming sequence by scanning the SWITCH bar code.

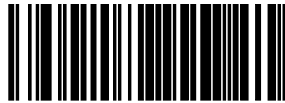

CODE 128 TRANSMIT FUNCTION CHARACTERS = DISABLE



CODE 128 TRANSMIT FUNCTION CHARACTERS = ENABLE

Convert Code128 to Code 39

Enables/disables conversion of Code 128 labels to Code 39.

To set this feature:

1. Scan the SWITCH bar code.
2. Scan either the enable or disable bar code below. You'll need to cover any unused bar codes on this and the facing page to ensure that the scanner reads only the bar code you intend to scan.
3. Complete the programming sequence by scanning the SWITCH bar code.

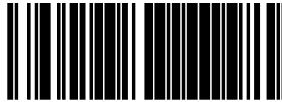

CONVERT CODE 128 TO CODE 39 = DISABLE



CONVERT CODE 128 TO CODE 39 = ENABLE

Code 128 AIM ID

This feature enables/disables transmission of the Code 128 AIM symbology identifier.

To set this feature:

1. Scan the SWITCH bar code.
2. Scan your selection from the bar codes below. You'll need to cover any unused bar codes on this and the facing page to ensure that the scanner reads only the bar code you intend to scan.
3. Complete the programming sequence by scanning the SWITCH bar code.



CODE 128 AIM ID = DISABLE



CODE 128 AIM ID = ENABLE

Code 128 Label ID

This feature specifies a Code 128 label ID to be added to bar code data..



NOTE

The programming feature, ***RS-232 Label ID Control***, designates whether the Label ID is transmitted as a prefix or suffix or if Label ID is disabled.

To set this feature:

1. Scan the SWITCH bar code.
2. Scan the bar code, *SET CODE 128 LABEL ID* below. You'll need to cover any unused bar codes on this and the facing page to ensure the scanner reads only the bar code you intend to scan.
3. Scan the appropriate digits from the keypad in *Appendix C* that represent the desired Label ID characters; entered as two hex pairs. A table containing the *ASCII Character Set* and their corresponding Hex Values is available in the inside back cover of this manual. ASCII parameters must be input by scanning a pair of hexadecimal digits for each character. Thus, to set a two-character value of AB, bar codes containing the digits '4', '1', '4', and '2' must be scanned. The selectable range for this option is any hex value from 00 to FF.
4. Complete the programming sequence by scanning the SWITCH bar code.

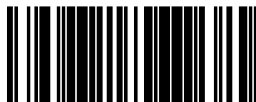

SET CODE 128 LABEL ID

Code 128 Length Control

This feature specifies whether variable-length or fixed-length decoding will be set for Code 128.

To set this feature:

1. Scan the SWITCH bar code.
2. Scan your selection from the bar codes below. You'll need to cover any unused bar codes on this and the facing page to ensure that the scanner reads only the bar code you intend to scan.
3. Complete the programming sequence by scanning the SWITCH bar code.



NOTE

If variable-length control was selected, you must now set the features ***Code 128 Maximum Label Length*** and ***Code 128 Minimum Label Length***. If fixed-length control was selected, you must now set ***Code 128 Fixed Length 1*** and ***Code 128 Fixed Length 2***.



CODE 128 LENGTH CONTROL = VARIABLE-LENGTH



CODE 128 LENGTH CONTROL = FIXED-LENGTH

Code 128 Maximum Label Length

This feature specifies the maximum allowable length of a Code 128 label.

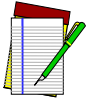

NOTE

Length in this case includes function characters and data characters, but does not include function code change or check character. This feature applies when *Code 128 Length Control* is set to variable-length decoding.

Maximum label length should be greater than or equal to minimum label length.

To set this feature:

1. Scan the SWITCH bar code.
2. Scan the bar code, *SET CODE 128 MAXIMUM LABEL LENGTH* below. You'll need to cover any unused bar codes on this and the facing page to ensure that the scanner reads only the bar code you intend to scan.
3. Scan the appropriate digits from the keypad in *Appendix C* that represent the desired maximum label length. The selectable range for this option is 01 to 80. Pad all single digit numbers with a leading zero to yield a two-digit entry (01-80).
4. Complete the programming sequence by scanning the SWITCH bar code.



SET CODE 128 MAXIMUM LABEL LENGTH

Code 128 Minimum Label Length

This feature specifies the minimum allowable length of a Code 128 label.



NOTE

Length in this case includes function characters and data characters, but does not include function code change or check character. This feature applies when *Code 128 Length Control* is set to variable-length decoding.

Minimum label length should be less than or equal to maximum label length.

To set this feature:

1. Scan the SWITCH bar code.
2. Scan the bar code, *SET CODE 128 MINIMUM LABEL LENGTH* below. You'll need to cover any unused bar codes on this and the facing page to ensure that the scanner reads only the bar code you intend to scan.
3. Scan the appropriate digits from the keypad in *Appendix C* that represent the desired minimum label length. The selectable range for this option is 01 to 80. Pad all single digit numbers with a leading zero to yield a two-digit entry (01-80).
4. Complete the programming sequence by scanning the SWITCH bar code.



SET CODE 128 MINIMUM LABEL LENGTH

Code 128 Fixed Length 1

This feature specifies Code 128 first fixed length.



NOTE

This applies when **Code 128 Length Control** is set to fixed-length decoding.

To set this feature:

1. Scan the SWITCH bar code.
2. Scan the bar code, *SET CODE 128 FIXED LENGTH 1* below. You'll need to cover any unused bar codes on this and the facing page to ensure that the scanner reads only the bar code you intend to scan.
3. Scan the appropriate digits from the keypad in *Appendix C* that represent the desired fixed label length. The selectable range for this option is 01 to 80. Pad all single digit numbers with a leading zero to yield a two-digit entry (01-80).
4. Complete the programming sequence by scanning the SWITCH bar code.

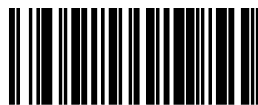

SET CODE 128 FIXED LENGTH 1

Code 128 Fixed Length 2

This feature specifies Code 128 second fixed length.



NOTE

This applies when **Code 128 Length Control** is set to fixed-length decoding.

If **Fixed Length 2** is set to 00 (zero), then **Fixed Length 1** will apply.

To set this feature:

1. Scan the SWITCH bar code.
2. Scan the bar code, *SET CODE 128 FIXED LENGTH 2* below. You'll need to cover any unused bar codes on this and the facing page to ensure that the scanner reads only the bar code you intend to scan.
3. Scan the appropriate digits from the keypad in *Appendix C* that represent the desired fixed label length. The selectable range for this option is 01 to 80. Pad all single digit numbers with a leading zero to yield a two-digit entry (01-80).
4. Complete the programming sequence by scanning the SWITCH bar code.

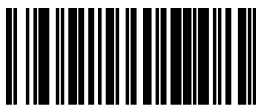

SET CODE 128 FIXED LENGTH 2

Code 128 Stitching

Enables/disables stitching for Code 128 labels. When parts of a Code 128 bar code are presented to the scanner with this feature enabled, the bar code parts will be assembled by the scanner's software, and the data will be decoded if all bar code proofing requirements are met.

To set this feature:

1. Scan the SWITCH bar code.
2. Scan your selection from the bar codes below. You'll need to cover any unused bar codes on this and the facing page to ensure that the scanner reads only the bar code you intend to scan.

Complete the programming sequence by scanning the SWITCH bar code.



CODE 128 STITCHING = DISABLE



CODE 128 STITCHING = ENABLE

EAN-128 Enable

Enables/disables the ability of the scanner to decode EAN-128 labels.

To set this feature:

1. Scan the SWITCH bar code.
2. Scan either the enable or disable bar code below. You'll need to cover any unused bar codes on this and the facing page to ensure that the scanner reads only the bar code you intend to scan.
3. Complete the programming sequence by scanning the SWITCH bar code.

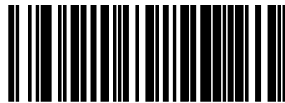

EAN-128 = DISABLE



EAN-128 = ENABLE

EAN 128 AIM ID

This feature enables/disables transmission of the EAN 128 AIM symbology identifier.

To set this feature:

1. Scan the SWITCH bar code.
2. Scan your selection from the bar codes below. You'll need to cover any unused bar codes on this and the facing page to ensure that the scanner reads only the bar code you intend to scan.
3. Complete the programming sequence by scanning the SWITCH bar code.



EAN 128 AIM ID = DISABLE



EAN 128 AIM ID = ENABLE

EAN 128 Label ID

This feature specifies an EAN 128 label ID to be added to bar code data..



NOTE

The programming feature, ***RS-232 Label ID Control***, designates whether the Label ID is transmitted as a prefix or suffix or if Label ID is disabled.

To set this feature:

1. Scan the SWITCH bar code.
2. Scan the bar code, *SET EAN 128 LABEL ID* below. You'll need to cover any unused bar codes on this and the facing page to ensure the scanner reads only the bar code you intend to scan.
3. Scan the appropriate digits from the keypad in *Appendix C* that represent the desired Label ID characters; entered as two hex pairs. A table containing the *ASCII Character Set* and their corresponding Hex Values is available in the inside back cover of this manual. ASCII parameters must be input by scanning a pair of hexadecimal digits for each character. Thus, to set a two-character value of AB, bar codes containing the digits '4', '1', '4', and '2' must be scanned. The selectable range for this option is any hex value from 00 to FF.
4. Complete the programming sequence by scanning the SWITCH bar code.

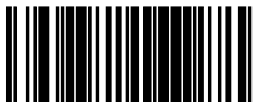

SET EAN 128 LABEL ID

Interleaved 2 of 5 (I 2 OF 5) Enable

Enables/disables the ability of the scanner to decode Interleaved 2 of 5 labels.

To set this feature:

1. Scan the SWITCH bar code.
2. Scan either the enable or disable bar code below. You'll need to cover any unused bar codes on this and the facing page to ensure that the scanner reads only the bar code you intend to scan.
3. Complete the programming sequence by scanning the SWITCH bar code.



I 2 OF 5 = DISABLE

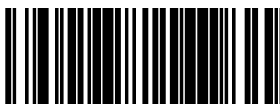

I 2 OF 5 = ENABLE

I 2 of 5 Check Character Calculation

Enables/disables calculation and verification of an optional Interleaved 2 of 5 check character.

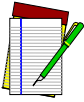

NOTE

If check character calculation is disabled, the risk is increased that a mis-read can occur. When disabled, any check characters in a bar code are treated as data characters.

To set this feature:

1. Scan the SWITCH bar code.
2. Scan either the enable or disable bar code below. You'll need to cover any unused bar codes on this and the facing page to ensure that the scanner reads only the bar code you intend to scan.
3. Complete the programming sequence by scanning the SWITCH bar code.



I 2 of 5 CHECK CHARACTER CALCULATION = DISABLE



I 2 of 5 CHECK CHARACTER CALCULATION = ENABLE

I 2 of 5 Check Character Transmission

Enables/disables transmission of an optional Interleaved 2 of 5 check character.

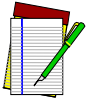

NOTE

This feature applies only when *I 2 of 5 Check Character Calculation* is enabled. This item is ignored when the advanced feature, Full Label Edit, is enabled.

To set this feature:

1. Scan the SWITCH bar code.
2. Scan either the enable or disable bar code below. You'll need to cover any unused bar codes on this and the facing page to ensure that the scanner reads only the bar code you intend to scan.
3. Complete the programming sequence by scanning the SWITCH bar code.

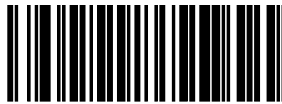

I 2 of 5 CHECK CHARACTER TRANSMISSION = DISABLE

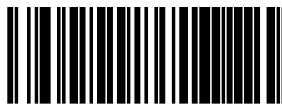

I 2 of 5 CHECK CHARACTER TRANSMISSION = ENABLE

I 2 of 5 AIM ID

This feature enables/disables transmission of the I 2 of 5 AIM symbology identifier.

To set this feature:

1. Scan the SWITCH bar code.
2. Scan your selection from the bar codes below. You'll need to cover any unused bar codes on this and the facing page to ensure that the scanner reads only the bar code you intend to scan.
3. Complete the programming sequence by scanning the SWITCH bar code.

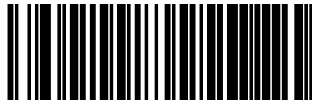

I 2 of 5 AIM ID = DISABLE



I 2 of 5 AIM ID = ENABLE

I 2 of 5 Label ID

This feature specifies an I 2 of 5 label ID to be added to bar code data..



NOTE

The programming feature, ***RS-232 Label ID Control***, designates whether the Label ID is transmitted as a prefix or suffix or if Label ID is disabled.

To set this feature:

1. Scan the SWITCH bar code.
2. Scan the bar code, *SET I 2 of 5 LABEL ID* below. You'll need to cover any unused bar codes on this and the facing page to ensure the scanner reads only the bar code you intend to scan.
3. Scan the appropriate digits from the keypad in *Appendix C* that represent the desired Label ID characters; entered as two hex pairs. A table containing the *ASCII Character Set* and their corresponding Hex Values is available in the inside back cover of this manual. ASCII parameters must be input by scanning a pair of hexadecimal digits for each character. Thus, to set a two-character value of AB, bar codes containing the digits '4', '1', '4', and '2' must be scanned. The selectable range for this option is any hex value from 00 to FF.
4. Complete the programming sequence by scanning the SWITCH bar code.

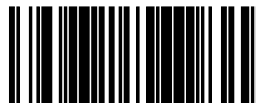

SET I 2 of 5 LABEL ID

I 2 of 5 Length Control

This feature specifies whether variable-length or fixed-length decoding will be set for I 2 of 5.

To set this feature:

1. Scan the SWITCH bar code.
2. Scan your selection from the bar codes below. You'll need to cover any unused bar codes on this and the facing page to ensure that the scanner reads only the bar code you intend to scan.
3. Complete the programming sequence by scanning the SWITCH bar code.



If variable-length control was selected, you must now set the features *I 2 of 5 Maximum Label Length* and *I 2 of 5 Minimum Label Length*. If fixed-length control was selected, you must now set *I 2 of 5 Fixed Length 1* and *I 2 of 5 Fixed Length 2*.



I 2 OF 5 LENGTH CONTROL = VARIABLE-LENGTH



I 2 OF 5 LENGTH CONTROL = FIXED-LENGTH

I 2 of 5 Maximum Label Length

This feature specifies the maximum allowable length of an I 2 of 5 label.



NOTE

Length in this case includes check and data characters, but does not include start or stop characters. This feature applies when *I 2 of 5 Length Control* is set to variable-length decoding.

Maximum label length should be greater than or equal to minimum label length.

To set this feature:

1. Scan the SWITCH bar code.
2. Scan the bar code, *SET I 2 OF 5 MAXIMUM LABEL LENGTH* below. You'll need to cover any unused bar codes on this and the facing page to ensure that the scanner reads only the bar code you intend to scan.
3. Scan the appropriate digits from the keypad in *Appendix C* that represent the desired maximum label length. The selectable range for this option is 02 to 50, even numbers only. Pad all single digit numbers with a leading zero to yield a two-digit entry (02-50).
4. Complete the programming sequence by scanning the SWITCH bar code.



SET I 2 OF 5 MAXIMUM LABEL LENGTH

I 2 of 5 Minimum Label Length

This feature specifies the minimum allowable length of an I 2 of 5 label.



NOTE

Length in this case includes check and data characters, but does not include start or stop characters. This feature applies when *I 2 of 5 Length Control* is set to variable-length decoding.

Minimum label length should be less than or equal to maximum label length.

To set this feature:

1. Scan the SWITCH bar code.
2. Scan the bar code, *SET I 2 OF 5 MINIMUM LABEL LENGTH* below. You'll need to cover any unused bar codes on this and the facing page to ensure that the scanner reads only the bar code you intend to scan.
3. Scan the appropriate digits from the keypad in *Appendix C* that represent the desired minimum label length. The selectable range for this option is 02 to 50, even numbers only. Pad all single digit numbers with a leading zero to yield a two-digit entry (02-50).
4. Complete the programming sequence by scanning the SWITCH bar code.



SET I 2 OF 5 MINIMUM LABEL LENGTH

I 2 of 5 Fixed Length 1

This feature specifies I 2 of 5 first fixed length.



NOTE

This applies when *I 2 of 5 Length Control* is set to fixed-length decoding.

To set this feature:

1. Scan the SWITCH bar code.
2. Scan the bar code, *SET I 2 OF 5 FIXED LENGTH 1* below. You'll need to cover any unused bar codes on this and the facing page to ensure that the scanner reads only the bar code you intend to scan.
3. Scan the appropriate digits from the keypad in *Appendix C* that represent the desired fixed label length. The selectable range for this option is 02 to 50, even numbers only. Pad all single digit numbers with a leading zero to yield a two-digit entry (02-50).
4. Complete the programming sequence by scanning the SWITCH bar code.

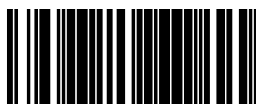

SET I 2 OF 5 FIXED LENGTH 1

I 2 of 5 Fixed Length 2

This feature specifies I 2 of 5 second fixed length.



NOTE

This applies when *I 2 of 5 Length Control* is set to fixed-length decoding.

If Fixed Length 2 is set to 00 (zero), then Fixed Length 1 will apply.

To set this feature:

1. Scan the SWITCH bar code.
2. Scan the bar code, *SET I 2 OF 5 FIXED LENGTH 2* below. You'll need to cover any unused bar codes on this and the facing page to ensure that the scanner reads only the bar code you intend to scan.
3. Scan the appropriate digits from the keypad in *Appendix C* that represent the desired fixed label length. The selectable range for this option is 00, or 02 to 50; even numbers only. Pad all single digit numbers with a leading zero to yield a two-digit entry (02-50).
4. Complete the programming sequence by scanning the SWITCH bar code.

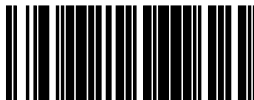

SET I 2 OF 5 FIXED LENGTH 2

I 2 of 5 Stitching

Enables/disables stitching for I 2 of 5 labels. When parts of an I 2 of 5 bar code are presented to the scanner with this feature enabled, the bar code parts will be assembled by the scanner's software, and the data will be decoded if all bar code proofing requirements are met.

To set this feature:

1. Scan the SWITCH bar code.
2. Scan your selection from the bar codes below. You'll need to cover any unused bar codes on this and the facing page to ensure that the scanner reads only the bar code you intend to scan.
3. Complete the programming sequence by scanning the SWITCH bar code.



NOTE

I 2 of 5 Stitching operates using fixed lengths ONLY. I 2 of 5 Fixed Length 1 and/or I 2 of 5 Fixed Length 2 must be properly configured for stitching to work.



I 2 OF 5 STITCHING = DISABLE



I 2 OF 5 STITCHING = ENABLE

Codabar Enable

Enables/disables the ability of the scanner to decode Codabar labels.

To set this feature:

1. Scan the SWITCH bar code.
2. Scan either the enable or disable bar code below. You'll need to cover any unused bar codes on this and the facing page to ensure that the scanner reads only the bar code you intend to scan.
3. Complete the programming sequence by scanning the SWITCH bar code.

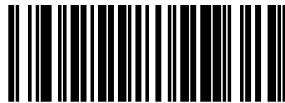

CODABAR = DISABLE



CODABAR = ENABLE

Codabar Start Stop Character Transmission

Enables/disables transmission of Codabar start and stop characters.

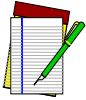

NOTE

This item is ignored when the advanced feature, Full Label Edit, is enabled.

To set this feature:

1. Scan the SWITCH bar code.
2. Scan either the enable or disable bar code below. You'll need to cover any unused bar codes on this and the facing page to ensure that the scanner reads only the bar code you intend to scan.
3. Complete the programming sequence by scanning the SWITCH bar code.

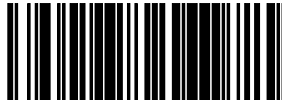

CODABAR START STOP CHARACTER TRANSMISSION = DISABLE



CODABAR START STOP CHARACTER TRANSMISSION = ENABLE

Codabar Start Stop Character Set

This feature selects the format of transmitted Codabar start/stop characters.

Options are:

- ABCD/TN* E
- ABCD/ABCD
- abcd/tn* e
- abcd/abcd

To set this feature:

1. Scan the SWITCH bar code.
2. Scan the bar code below or from the following page representing the desired option. You'll need to cover any unused bar codes and facing pages to ensure that the scanner reads only the bar code you intend to scan.
3. Complete the programming sequence by scanning the SWITCH bar code.

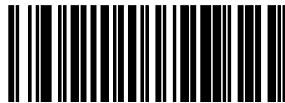

CODABAR START STOP CHARACTER = ABCD/TN* E



CODABAR START STOP CHARACTER = ABCD/ABCD

Codabar Start Stop Character Set — continued

Remember to cover any unused bar codes on this and the facing page to ensure that the scanner reads only the bar code you intend to scan.



CODABAR START STOP CHARACTER = abcd/tn* e



CODABAR START STOP CHARACTER = abcd/abcd

Codabar Start Stop Character Match

Enables/disables the requirement that start and stop characters match.

To set this feature:

1. Scan the SWITCH bar code.
2. Scan either the enable or disable bar code below. You'll need to cover any unused bar codes on this and the facing page to ensure that the scanner reads only the bar code you intend to scan.
3. Complete the programming sequence by scanning the SWITCH bar code.

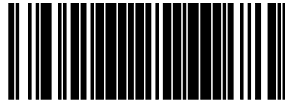

CODABAR START STOP CHARACTER MATCH = DISABLE

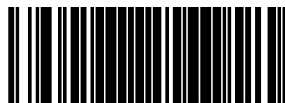

CODABAR START STOP CHARACTER MATCH = ENABLE

Codabar Check Character Calculation

Enables/disables calculation and verification of an optional Codabar check character.



NOTE

If check character calculation is disabled, the risk is increased that a mis-read can occur. When disabled, any check characters in a bar code are treated as data characters.

To set this feature:

1. Scan the SWITCH bar code.
2. Scan either the enable or disable bar code below. You'll need to cover any unused bar codes on this and the facing page to ensure that the scanner reads only the bar code you intend to scan.
3. Complete the programming sequence by scanning the SWITCH bar code.



CODABAR CHECK CHARACTER CALCULATION = DISABLE



CODABAR CHECK CHARACTER CALCULATION = ENABLE

Codabar Check Character Transmission

Enables/disables transmission of an optional Codabar check character.



NOTE

Applies only when *Codabar Check Character Calculation* is enabled.
This item is ignored when the advanced feature, Full Label Edit, is enabled.

To set this feature:

1. Scan the SWITCH bar code.
2. Scan either the enable or disable bar code below. You'll need to cover any unused bar codes on this and the facing page to ensure that the scanner reads only the bar code you intend to scan.
3. Complete the programming sequence by scanning the SWITCH bar code.



CODABAR CHECK CHARACTER TRANSMISSION = DISABLE



CODABAR CHECK CHARACTER TRANSMISSION = ENABLE

Codabar AIM ID

This feature enables/disables transmission of the Codabar AIM symbology identifier.

To set this feature:

1. Scan the SWITCH bar code.
2. Scan your selection from the bar codes below. You'll need to cover any unused bar codes on this and the facing page to ensure that the scanner reads only the bar code you intend to scan.
3. Complete the programming sequence by scanning the SWITCH bar code.

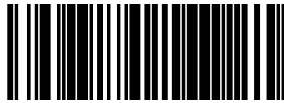

CODABAR AIM ID = DISABLE



CODABAR AIM ID = ENABLE

Codabar Label ID

This feature specifies a Codabar label ID to be added to bar code data.



NOTE

The programming feature, ***RS-232 Label ID Control***, designates whether the Label ID is transmitted as a prefix or suffix or if Label ID is disabled.

To set this feature:

1. Scan the SWITCH bar code.
2. Scan the bar code, *SET CODABAR LABEL ID* below. You'll need to cover any unused bar codes on this and the facing page to ensure the scanner reads only the bar code you intend to scan.
3. Scan the appropriate digits from the keypad in *Appendix C* that represent the desired Label ID characters; entered as two hex pairs. A table containing the *ASCII Character Set* and their corresponding Hex Values is available in the inside back cover of this manual. ASCII parameters must be input by scanning a pair of hexadecimal digits for each character. Thus, to set a two-character value of AB, bar codes containing the digits '4', '1', '4', and '2' must be scanned. The selectable range for this option is any hex value from 00 to FF.
4. Complete the programming sequence by scanning the SWITCH bar code.

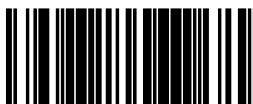

SET CODABAR LABEL ID

Codabar Length Control

This feature specifies whether variable-length or fixed-length decoding will be set for Codabar.

To set this feature:

1. Scan the SWITCH bar code.
2. Scan your selection from the bar codes below. You'll need to cover any unused bar codes on this and the facing page to ensure that the scanner reads only the bar code you intend to scan.
3. Complete the programming sequence by scanning the SWITCH bar code.



If variable-length control was selected, you must now set the features ***Codabar Maximum Label Length*** and ***Codabar Minimum Label Length***. If fixed-length control was selected, you must now set ***Codabar Fixed Length 1*** and ***Codabar Fixed Length 2***.



CODABAR LENGTH CONTROL = VARIABLE-LENGTH



CODABAR LENGTH CONTROL = FIXED-LENGTH

Codabar Maximum Label Length

This feature specifies the maximum allowable length of a Codabar label.



NOTE

Length in this case includes start, stop or check and data characters, but does not include full ASCII shift characters. This feature applies when *Codabar Length Control* is set to variable-length decoding.

Maximum label length should be greater than or equal to minimum label length.

To set this feature:

1. Scan the SWITCH bar code.
2. Scan the bar code, *SET CODABAR MAXIMUM LABEL LENGTH* below. You'll need to cover any unused bar codes on this and the facing page to ensure that the scanner reads only the bar code you intend to scan.
3. Scan the appropriate digits from the keypad in *Appendix C* that represent the desired maximum label length. The selectable range for this option is 03 to 50. Pad all single digit numbers with a leading zero to yield a two-digit entry (03-50).
4. Complete the programming sequence by scanning the SWITCH bar code.



SET CODABAR MAXIMUM LABEL LENGTH

Codabar Minimum Label Length

This feature specifies the minimum allowable length of a Codabar label.



NOTE

Length in this case includes start, stop or check and data characters, but does not include full ASCII shift characters. This feature applies when *Codabar Length Control* is set to variable-length decoding.

Minimum label length should be less than or equal to maximum label length.

To set this feature:

1. Scan the SWITCH bar code.
2. Scan the bar code, *SET CODABAR MINIMUM LABEL LENGTH* below. You'll need to cover any unused bar codes on this and the facing page to ensure that the scanner reads only the bar code you intend to scan.
3. Scan the appropriate digits from the keypad in *Appendix C* that represent the desired minimum label length. The selectable range for this option is 03 to 50. Pad all single digit numbers with a leading zero to yield a two-digit entry (03-50).
4. Complete the programming sequence by scanning the SWITCH bar code.



SET CODABAR MINIMUM LABEL LENGTH

Codabar Fixed Length 1

This feature specifies Codabar first fixed length.



NOTE

Length in this case includes start, stop or check and data characters, but does not include full ASCII shift characters.

This feature applies when *Codabar Length Control* is set to fixed-length decoding.

Decodable length is four when the optional check character is present.

To set this feature:

1. Scan the SWITCH bar code.
2. Scan the bar code, *SET CODABAR FIXED LENGTH 1* below. You'll need to cover any unused bar codes on this and the facing page to ensure that the scanner reads only the bar code you intend to scan.
3. Scan the appropriate digits from the keypad in *Appendix C* that represent the desired fixed label length. The selectable range for this option is 03 to 50. Pad all single digit numbers with a leading zero to yield a two-digit entry (03-50).
4. Complete the programming sequence by scanning the SWITCH bar code.

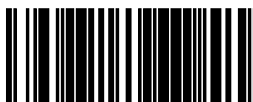

SET CODABAR FIXED LENGTH 1

Codabar Fixed Length 2

This feature specifies Codabar second fixed length.



NOTE

Length in this case includes start, stop or check and data characters, but does not include full ASCII shift characters.

This feature applies when *Codabar Length Control* is set to fixed-length decoding.

Decodable length is four when the optional check character is present.

If Fixed Length 2 is set to 00 (zero), then Fixed Length 1 will apply.

To set this feature:

1. Scan the SWITCH bar code.
2. Scan the bar code, *SET CODABAR FIXED LENGTH 2* below. You'll need to cover any unused bar codes on this and the facing page to ensure that the scanner reads only the bar code you intend to scan.
3. Scan the appropriate digits from the keypad in *Appendix C* that represent the desired fixed label length. The selectable range for this option is 00, or 03 to 50. Pad all single digit numbers with a leading zero to yield a two-digit entry (03-50).
4. Complete the programming sequence by scanning the SWITCH bar code.

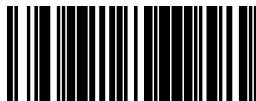

SET CODABAR FIXED LENGTH 2

Codabar Stitching

Enables/disables stitching for Codabar labels. When parts of a Codabar bar code are presented to the scanner with this feature enabled, the bar code parts will be assembled by the scanner's software, and the data will be decoded if all bar code proofing requirements are met.

To set this feature:

1. Scan the SWITCH bar code.
2. Scan your selection from the bar codes below. You'll need to cover any unused bar codes on this and the facing page to ensure that the scanner reads only the bar code you intend to scan.

Complete the programming sequence by scanning the SWITCH bar code.



NOTE

Codabar Stitching operates using fixed lengths ONLY. Codabar Fixed Length 1 and/or Codabar Fixed Length 2 must be properly configured for stitching to work.



CODABAR STITCHING = DISABLE



CODABAR STITCHING = ENABLE

Code 93 Enable

Enables/disables the ability of the scanner to decode Code 93 labels.

To set this feature:

1. Scan the SWITCH bar code.
2. Scan either the enable or disable bar code below. You'll need to cover any unused bar codes on this and the facing page to ensure that the scanner reads only the bar code you intend to scan.
3. Complete the programming sequence by scanning the SWITCH bar code.



CODE 93 = DISABLE



CODE 93 = ENABLE

Code 93 AIM ID

This feature enables/disables transmission of the Code 93 AIM symbology identifier.

To set this feature:

1. Scan the SWITCH bar code.
2. Scan your selection from the bar codes below. You'll need to cover any unused bar codes on this and the facing page to ensure that the scanner reads only the bar code you intend to scan.
3. Complete the programming sequence by scanning the SWITCH bar code.



CODE 93 AIM ID = DISABLE



CODE 93 AIM ID = ENABLE

Code 93 Label ID

This feature specifies a Code 93 label ID to be added to bar code data..



NOTE

The programming feature, ***RS-232 Label ID Control***, designates whether the Label ID is transmitted as a prefix or suffix or if Label ID is disabled.

To set this feature:

1. Scan the SWITCH bar code.
2. Scan the bar code, *SET CODE 93 LABEL ID* below. You'll need to cover any unused bar codes on this and the facing page to ensure the scanner reads only the bar code you intend to scan.
3. Scan the appropriate digits from the keypad in *Appendix C* that represent the desired Label ID characters; entered as two hex pairs. A table containing the *ASCII Character Set* and their corresponding Hex Values is available in the inside back cover of this manual. ASCII parameters must be input by scanning a pair of hexadecimal digits for each character. Thus, to set a two-character value of AB, bar codes containing the digits '4', '1', '4', and '2' must be scanned. The selectable range for this option is any hex value from 00 to FF.
4. Complete the programming sequence by scanning the SWITCH bar code.

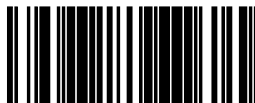

SET CODE 93 LABEL ID

Code 93 Length Control

This feature specifies whether variable-length or fixed-length decoding will be set for Code 93.

To set this feature:

1. Scan the SWITCH bar code.
2. Scan your selection from the bar codes below. You'll need to cover any unused bar codes on this and the facing page to ensure that the scanner reads only the bar code you intend to scan.
3. Complete the programming sequence by scanning the SWITCH bar code.

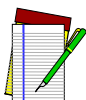

NOTE

If variable-length control was selected, you must now set the features **Code 93 Maximum Label Length** and **Code 93 Minimum Label Length**. If fixed-length control was selected, you must now set **Code 93 Fixed Length 1** and **Code 93 Fixed Length 2**.



CODE 93 LENGTH CONTROL = VARIABLE-LENGTH



CODE 93 LENGTH CONTROL = FIXED-LENGTH

Code 93 Maximum Label Length

This feature specifies the maximum allowable length of a Code 93 label.



NOTE

Length in this case includes data characters, but does not include start, stop, full ASCII shift, or check characters. This feature applies when *Code 93 Length Control* is set to variable-length decoding.

Maximum label length should be greater than or equal to minimum label length.

To set this feature:

1. Scan the SWITCH bar code.
2. Scan the bar code, *SET CODE 93 MAXIMUM LABEL LENGTH* below. You'll need to cover any unused bar codes on this and the facing page to ensure that the scanner reads only the bar code you intend to scan.
3. Scan the appropriate digits from the keypad in *Appendix C* that represent the desired maximum label length. The selectable range for this option is 01 to 50. Pad all single digit numbers with a leading zero to yield a two-digit entry (01-50).
4. Complete the programming sequence by scanning the SWITCH bar code.



SET CODE 93 MAXIMUM LABEL LENGTH

Code 93 Minimum Label Length

This feature specifies the minimum allowable length of a Code 93 label.



NOTE

Length in this case includes data characters, but does not include start, stop, full ASCII shift, or check characters. This feature applies when *Code 93 Length Control* is set to variable-length decoding.

Minimum label length should be less than or equal to maximum label length.

To set this feature:

1. Scan the SWITCH bar code.
2. Scan the bar code, *SET CODE 93 MINIMUM LABEL LENGTH* below. You'll need to cover any unused bar codes on this and the facing page to ensure that the scanner reads only the bar code you intend to scan.
3. Scan the appropriate digits from the keypad in *Appendix C* that represent the desired minimum label length. The selectable range for this option is 01 to 50. Pad all single digit numbers with a leading zero to yield a two-digit entry (01-50).
4. Complete the programming sequence by scanning the SWITCH bar code.



SET CODE 93 MINIMUM LABEL LENGTH

Code 93 Fixed Length 1

This feature specifies Code 93 first fixed length.



NOTE

This applies when **Code 93 Length Control** is set to fixed-length decoding.

To set this feature:

1. Scan the SWITCH bar code.
2. Scan the bar code, *SET CODE 93 FIXED LENGTH 1* below. You'll need to cover any unused bar codes on this and the facing page to ensure that the scanner reads only the bar code you intend to scan.
3. Scan the appropriate digits from the keypad in *Appendix C* that represent the desired fixed label length. The selectable range for this option is 01 to 50. Pad all single digit numbers with a leading zero to yield a two-digit entry (01-50).
4. Complete the programming sequence by scanning the SWITCH bar code.

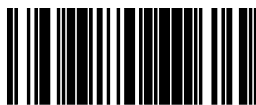

SET CODE 93 FIXED LENGTH 1

Code 93 Fixed Length 2

This feature specifies Code 93 second fixed length.



NOTE

This applies when **Code 93 Length Control** is set to fixed-length decoding.

If **Fixed Length 2** is set to 00 (zero), then **Fixed Length 1** will apply.

To set this feature:

1. Scan the SWITCH bar code.
2. Scan the bar code, *SET CODE 93 FIXED LENGTH 2* below. You'll need to cover any unused bar codes on this and the facing page to ensure that the scanner reads only the bar code you intend to scan.
3. Scan the appropriate digits from the keypad in *Appendix C* that represent the desired fixed label length. The selectable range for this option is 00, or 01 to 50. Pad all single digit numbers with a leading zero to yield a two-digit entry (01-50).
4. Complete the programming sequence by scanning the SWITCH bar code.

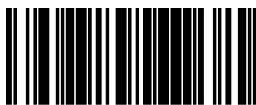

SET CODE 93 FIXED LENGTH 2

Code 93 Stitching

Enables/disables stitching for Code 93 labels. When parts of a Code 93 bar code are presented to the scanner with this feature enabled, the bar code parts will be assembled by the scanner's software, and the data will be decoded if all bar code proofing requirements are met.

To set this feature:

1. Scan the SWITCH bar code.
2. Scan your selection from the bar codes below. You'll need to cover any unused bar codes on this and the facing page to ensure that the scanner reads only the bar code you intend to scan.

Complete the programming sequence by scanning the SWITCH bar code.



CODE 93 STITCHING = DISABLE



CODE 93 STITCHING = ENABLE

MSI/Plessey Enable

Enables/disables the ability of the scanner to decode MSI/Plessey labels.

To set this feature:

1. Scan the SWITCH bar code.
2. Scan either the enable or disable bar code below. You'll need to cover any unused bar codes on this and the facing page to ensure that the scanner reads only the bar code you intend to scan.
3. Complete the programming sequence by scanning the SWITCH bar code.



MSI/PLESSEY = DISABLE



MSI/PLESSEY = ENABLE

MSI/Plessey Check Character Calculation

Enables/disables calculation and verification of optional MSI/Plessey check characters.



NOTE

If check character calculation is disabled, the risk is increased that a mis-read can occur. When disabled, any check characters in a bar code are treated as data characters.

To set this feature:

1. Scan the SWITCH bar code.
2. Scan either the enable or disable bar code below. You'll need to cover any unused bar codes on this and the facing page to ensure that the scanner reads only the bar code you intend to scan.
3. Complete the programming sequence by scanning the SWITCH bar code.

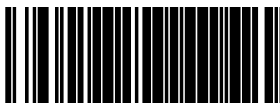

MSI/PLESSEY CHECK CHARACTER CALCULATION = DISABLE

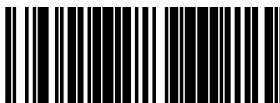

MSI/PLESSEY CHECK CHARACTER CALCULATION = ENABLE

MSI/Plessey Number of Check Characters

Specifies number of MSI/Plessey check characters to be calculated and verified.



NOTE

Check characters are always modulus 10.

To set this feature:

1. Scan the SWITCH bar code.
2. Scan the bar code below representing the desired number of MSI/Plessey check characters to be calculated and verified. You'll need to cover any unused bar codes on this and the facing page to ensure that the scanner reads only the bar code you intend to scan.
3. Complete the programming sequence by scanning the SWITCH bar code.



MSI/PLESSEY NUMBER OF CHECK CHARACTERS = 1



MSI/PLESSEY NUMBER OF CHECK CHARACTERS = 2

MSI/Plessey Check Character Transmission

Enables/disables transmission of optional MSI/Plessey check characters.



NOTE

This feature applies only when *MSI/Plessey Check Character Calculation* is enabled. This item is ignored when the advanced feature, Full Label Edit, is enabled.

To set this feature:

1. Scan the SWITCH bar code.
2. Scan either the enable or disable bar code below. You'll need to cover any unused bar codes on this and the facing page to ensure that the scanner reads only the bar code you intend to scan.
3. Complete the programming sequence by scanning the SWITCH bar code.

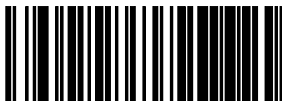

MSI/PLESSEY CHECK CHARACTER TRANSMISSION = DISABLE



MSI/PLESSEY CHECK CHARACTER TRANSMISSION = ENABLE

MSI/Plessey AIM ID

This feature enables/disables transmission of the MSI/Plessey AIM symbology identifier.

To set this feature:

1. Scan the SWITCH bar code.
2. Scan your selection from the bar codes below. You'll need to cover any unused bar codes on this and the facing page to ensure that the scanner reads only the bar code you intend to scan.
3. Complete the programming sequence by scanning the SWITCH bar code.



MSI/PLESSEY AIM ID = DISABLE



MSI/PLESSEY AIM ID = ENABLE

MSI/Plessey Label ID

This feature specifies an MSI/Plessey label ID to be added to bar code data.



NOTE

The programming feature, ***RS-232 Label ID Control***, designates whether the Label ID is transmitted as a prefix or suffix or if Label ID is disabled.

To set this feature:

1. Scan the SWITCH bar code.
2. Scan the bar code, *SET MSI/PLESSEY LABEL ID* below. You'll need to cover any unused bar codes on this and the facing page to ensure the scanner reads only the bar code you intend to scan.
3. Scan the appropriate digits from the keypad in *Appendix C* that represent the desired Label ID characters; entered as two hex pairs. A table containing the *ASCII Character Set* and their corresponding Hex Values is available in the inside back cover of this manual. ASCII parameters must be input by scanning a pair of hexadecimal digits for each character. Thus, to set a two-character value of AB, bar codes containing the digits '4', '1', '4', and '2' must be scanned. The selectable range for this option is any hex value from 00 to FF.
4. Complete the programming sequence by scanning the SWITCH bar code.



SET MSI/PLESSEY LABEL ID

MSI/Plessey Length Control

This feature specifies whether variable-length or fixed-length decoding will be set for MSI/Plessey.

To set this feature:

1. Scan the SWITCH bar code.
2. Scan your selection from the bar codes below. You'll need to cover any unused bar codes on this and the facing page to ensure that the scanner reads only the bar code you intend to scan.
3. Complete the programming sequence by scanning the SWITCH bar code.

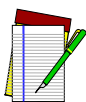

NOTE

If variable-length control was selected, you must now set the features *MSI/Plessey Maximum Label Length* and *MSI/Plessey Minimum Label Length*. If fixed-length control was selected, you must now set *1 2 of 5 Fixed Length 1* and *MSI/Plessey Fixed Length 2*.



MSI/PLESSEY LENGTH CONTROL = VARIABLE-LENGTH



MSI/PLESSEY LENGTH CONTROL = FIXED-LENGTH

MSI/Plessey Maximum Label Length

This feature specifies the maximum allowable length of an MSI/Plessey label.



NOTE

Length in this case includes check and data characters, but does not include start, stop or full ASCII shift characters. This feature applies when *MSI/Plessey Length Control* is set to variable-length decoding.

Maximum label length should be greater than or equal to minimum label length.

To set this feature:

1. Scan the SWITCH bar code.
2. Scan the bar code, *SET MSI/PLESSEY MAXIMUM LABEL LENGTH* below. You'll need to cover any unused bar codes on this and the facing page to ensure that the scanner reads only the bar code you intend to scan.
3. Scan the appropriate digits from the keypad in *Appendix C* that represent the desired maximum label length. The selectable range for this option is 4 to 16. Pad all single digit numbers with a leading zero to yield a two-digit entry (04-16).
4. Complete the programming sequence by scanning the SWITCH bar code.



SET MSI/PLESSEY MAXIMUM LABEL LENGTH

MSI/Plessey Minimum Label Length

This feature specifies the minimum allowable length of an MSI/Plessey label.



NOTE

Length in this case includes check and data characters, but does not include start, stop or full ASCII shift characters. This applies when *MSI/Plessey Length Control* is set to variable-length decoding.

Minimum label length should be less than or equal to maximum label length.

To set this feature:

1. Scan the SWITCH bar code.
2. Scan the bar code, *SET MSI/PLESSEY MINIMUM LABEL LENGTH* below. You'll need to cover any unused bar codes on this and the facing page to ensure that the scanner reads only the bar code you intend to scan.
3. Scan the appropriate digits from the keypad in *Appendix C* that represent the desired minimum label length. The selectable range for this option is 4 to 16. Pad all single digit numbers with a leading zero to yield a two-digit entry (04-16).
4. Complete the programming sequence by scanning the SWITCH bar code.

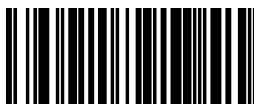

SET MSI/PLESSEY MINIMUM LABEL LENGTH

MSI/Plessey Fixed Length 1

This feature specifies MSI/Plessey first fixed length.



NOTE

This applies when **MSI/Plessey Length Control** is set to fixed-length decoding.

To set this feature:

1. Scan the SWITCH bar code.
2. Scan the bar code, *SET MSI/PLESSEY FIXED LENGTH 1* below. You'll need to cover any unused bar codes on this and the facing page to ensure that the scanner reads only the bar code you intend to scan.
3. Scan the appropriate digits from the keypad in *Appendix C* that represent the desired fixed label length. The selectable range for this option is 4 to 16. Pad all single digit numbers with a leading zero to yield a two-digit entry (04-16).
4. Complete the programming sequence by scanning the SWITCH bar code.



SET MSI/PLESSEY FIXED LENGTH 1

MSI/Plessey Fixed Length 2

This feature specifies MSI/Plessey second fixed length.



NOTE

This applies when **MSI/Plessey Length Control** is set to fixed-length decoding.

If Fixed Length 2 is set to 00 (zero), then Fixed Length 1 will apply.

To set this feature:

1. Scan the SWITCH bar code.
2. Scan the bar code, *SET MSI/PLESSEY FIXED LENGTH 2* below. You'll need to cover any unused bar codes on this and the facing page to ensure that the scanner reads only the bar code you intend to scan.
3. Scan the appropriate digits from the keypad in *Appendix C* that represent the desired fixed label length. The selectable range for this option is 0 (zero), or 4 to 16. Pad all single digit numbers with a leading zero to yield a two-digit entry (00, 04-16).
4. Complete the programming sequence by scanning the SWITCH bar code.

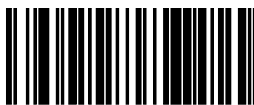

SET MSI/PLESSEY FIXED LENGTH 2

MSI/Plessey Stitching

Enables/disables stitching for MSI/Plessey labels. When parts of an MSI/Plessey bar code are presented to the scanner with this feature enabled, the bar code parts will be assembled by the scanner's software, and the data will be decoded if all bar code proofing requirements are met.

To set this feature:

1. Scan the SWITCH bar code.
2. Scan your selection from the bar codes below. You'll need to cover any unused bar codes on this and the facing page to ensure that the scanner reads only the bar code you intend to scan.
3. Complete the programming sequence by scanning the SWITCH bar code.



NOTE

MSI/Plessey Stitching operates using fixed lengths ONLY. MSI/Plessey Fixed Length 1 and/or MSI/Plessey Fixed Length 2 must be properly configured for stitching to work.



MSI/PLESSEY STITCHING = DISABLE



MSI/PLESSEY STITCHING = ENABLE

Standard 2 of 5 Enable

Enables/disables the ability of the scanner to decode Standard 2 of 5 labels.

To set this feature:

1. Scan the SWITCH bar code.
2. Scan either the enable or disable bar code below. You'll need to cover any unused bar codes on this and the facing page to ensure that the scanner reads only the bar code you intend to scan.
3. Complete the programming sequence by scanning the SWITCH bar code.

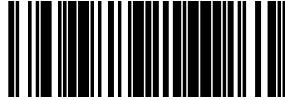

STANDARD 2 OF 5 = DISABLE



STANDARD 2 OF 5 = ENABLE

Standard 2 of 5 Check Character Calculation

Enables/disables calculation and verification of an optional Standard 2 of 5 check character.

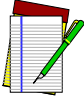

NOTE

If check character calculation is disabled, the risk is increased that a mis-read can occur. When disabled, any check character in a bar code is treated as data character.

To set this feature:

1. Scan the SWITCH bar code.
2. Scan either the enable or disable bar code below. You'll need to cover any unused bar codes on this and the facing page to ensure that the scanner reads only the bar code you intend to scan.
3. Complete the programming sequence by scanning the SWITCH bar code.



STANDARD 2 of 5 CHECK CHARACTER CALCULATION = DISABLE



STANDARD 2 of 5 CHECK CHARACTER CALCULATION = ENABLE

Standard 2 of 5 Check Character Transmission

Enables/disables transmission of an optional Standard 2 of 5 check character.



NOTE

This feature applies only when *Standard 2 of 5 Check Character Calculation* is enabled. This item is ignored when the advanced feature, *Full Label Edit*, is enabled.

To set this feature:

1. Scan the SWITCH bar code.
2. Scan either the enable or disable bar code below. You'll need to cover any unused bar codes on this and the facing page to ensure that the scanner reads only the bar code you intend to scan.
3. Complete the programming sequence by scanning the SWITCH bar code.



STANDARD 2 of 5 CHECK CHARACTER TRANSMISSION = DISABLE



STANDARD 2 of 5 CHECK CHARACTER TRANSMISSION = ENABLE

Standard 2 of 5 AIM ID

This feature enables/disables transmission of the Standard 2 of 5 AIM symbology identifier.

To set this feature:

1. Scan the SWITCH bar code.
2. Scan your selection from the bar codes below. You'll need to cover any unused bar codes on this and the facing page to ensure that the scanner reads only the bar code you intend to scan.
3. Complete the programming sequence by scanning the SWITCH bar code.

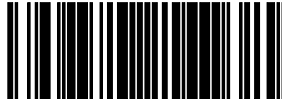

STANDARD 2 of 5 AIM ID = DISABLE

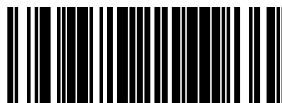

STANDARD 2 of 5 AIM ID = ENABLE

Standard 2 of 5 Label ID

This feature specifies an Standard 2 of 5 label ID to be added to bar code data.



NOTE

The programming feature, *RS-232 Label ID Control*, designates whether the Label ID is transmitted as a prefix or suffix or if Label ID is disabled.

To set this feature:

1. Scan the SWITCH bar code.
2. Scan the bar code, *SET STANDARD 2 of 5 LABEL ID* below. You'll need to cover any unused bar codes on this and the facing page to ensure the scanner reads only the bar code you intend to scan.
3. Scan the appropriate digits from the keypad in *Appendix C* that represent the desired Label ID characters; entered as two hex pairs. A table containing the *ASCII Character Set* and their corresponding Hex Values is available in the inside back cover of this manual. ASCII parameters must be input by scanning a pair of hexadecimal digits for each character. Thus, to set a two-character value of AB, bar codes containing the digits '4', '1', '4', and '2' must be scanned. The selectable range for this option is any hex value from 00 to FF.
4. Complete the programming sequence by scanning the SWITCH bar code.



SET STANDARD 2 of 5 LABEL ID

Standard 2 of 5 Length Control

This feature specifies whether variable-length or fixed-length decoding will be set for Standard 2 of 5.

To set this feature:

1. Scan the SWITCH bar code.
2. Scan your selection from the bar codes below. You'll need to cover any unused bar codes on this and the facing page to ensure that the scanner reads only the bar code you intend to scan.
3. Complete the programming sequence by scanning the SWITCH bar code.



NOTE

If variable-length control was selected, you must now set the features **Standard 2 of 5 Maximum Label Length** and **Standard 2 of 5 Minimum Label Length**. If fixed-length control was selected, you must now set **Standard 2 of 5 Fixed Length 1** and **Standard 2 of 5 Fixed Length 2**.



STANDARD 2 OF 5 LENGTH CONTROL = VARIABLE-LENGTH



STANDARD 2 OF 5 LENGTH CONTROL = FIXED-LENGTH

Standard 2 of 5 Maximum Label Length

This feature specifies the maximum allowable length of a Standard 2 of 5 label.



Length in this case includes check and data characters, but does not include start or stop characters. This feature applies when *Standard 2 of 5 Length Control* is set to variable-length decoding.

NOTE

Maximum label length should be greater than or equal to minimum label length.

To set this feature:

1. Scan the SWITCH bar code.
2. Scan the bar code, *SET STANDARD 2 OF 5 MAXIMUM LABEL LENGTH* below. You'll need to cover any unused bar codes on this and the facing page to ensure that the scanner reads only the bar code you intend to scan.
3. Scan the appropriate digits from the keypad in *Appendix C* that represent the desired maximum label length. The selectable range for this option is 01 to 50, even numbers only. Pad all single digit numbers with a leading zero to yield a two-digit entry (01-50).
4. Complete the programming sequence by scanning the SWITCH bar code.

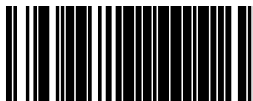

SET STANDARD 2 OF 5 MAXIMUM LABEL LENGTH

Standard 2 of 5 Minimum Label Length

This feature specifies the minimum allowable length of an Standard 2 of 5 label.



Length in this case includes check and data characters, but does not include start or stop characters. This feature applies when *Standard 2 of 5 Length Control* is set to variable-length decoding.

NOTE

Minimum label length should be less than or equal to maximum label length.

To set this feature:

1. Scan the SWITCH bar code.
2. Scan the bar code, *SET STANDARD 2 OF 5 MINIMUM LABEL LENGTH* below. You'll need to cover any unused bar codes on this and the facing page to ensure that the scanner reads only the bar code you intend to scan.
3. Scan the appropriate digits from the keypad in *Appendix C* that represent the desired minimum label length. The selectable range for this option is 01 to 50, even numbers only. Pad all single digit numbers with a leading zero to yield a two-digit entry (01-50).
4. Complete the programming sequence by scanning the SWITCH bar code.



SET STANDARD 2 OF 5 MINIMUM LABEL LENGTH

Standard 2 of 5 Fixed Length 1

This feature specifies Standard 2 of 5 first fixed length.



NOTE

This applies when **Standard 2 of 5 Length Control** is set to fixed-length decoding.

To set this feature:

1. Scan the SWITCH bar code.
2. Scan the bar code, *SET STANDARD 2 OF 5 FIXED LENGTH 1* below. You'll need to cover any unused bar codes on this and the facing page to ensure that the scanner reads only the bar code you intend to scan.
3. Scan the appropriate digits from the keypad in *Appendix C* that represent the desired fixed label length. The selectable range for this option is 1 to 50. Pad all single digit numbers with a leading zero to yield a two-digit entry (01-50).
4. Complete the programming sequence by scanning the SWITCH bar code.

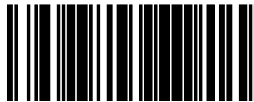

SET STANDARD 2 OF 5 FIXED LENGTH 1

Standard 2 of 5 Fixed Length 2

This feature specifies Standard 2 of 5 second fixed length.

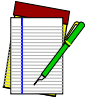

NOTE

This applies when **Standard 2 of 5 Length Control** is set to fixed-length decoding.

If Fixed Length 2 is set to 00 (zero), then Fixed Length 1 will apply.

To set this feature:

1. Scan the SWITCH bar code.
2. Scan the bar code, *SET STANDARD 2 OF 5 FIXED LENGTH 2* below. You'll need to cover any unused bar codes on this and the facing page to ensure that the scanner reads only the bar code you intend to scan.
3. Scan the appropriate digits from the keypad in *Appendix C* that represent the desired fixed label length. The selectable range for this option is 1 to 50. Pad all single digit numbers with a leading zero to yield a two-digit entry (01-50).
4. Complete the programming sequence by scanning the SWITCH bar code.

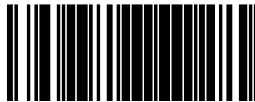

SET STANDARD 2 OF 5 FIXED LENGTH 2

Standard 2 of 5 Stitching

Enables/disables stitching for Standard 2 of 5 labels. When parts of a Standard 2 of 5 bar code are presented to the scanner with this feature enabled, the bar code parts will be assembled by the scanner's software, and the data will be decoded if all bar code proofing requirements are met.



NOTE

This applies when *Standard 2 of 5 Length Control* is set to fixed-length decoding.

To set this feature:

1. Scan the SWITCH bar code.
2. Scan your selection from the bar codes below. You'll need to cover any unused bar codes on this and the facing page to ensure that the scanner reads only the bar code you intend to scan.

Complete the programming sequence by scanning the SWITCH bar code.



STANDARD 2 OF 5 STITCHING = DISABLE



STANDARD 2 OF 5 STITCHING = ENABLE

NOTES

Appendix A

LED/Beeper Indications & Controls

Figure A-1 shows the operator's controls and indicators. The descriptions following identify the use or function of each component.

Figure A-1. Scanner and Scale Controls

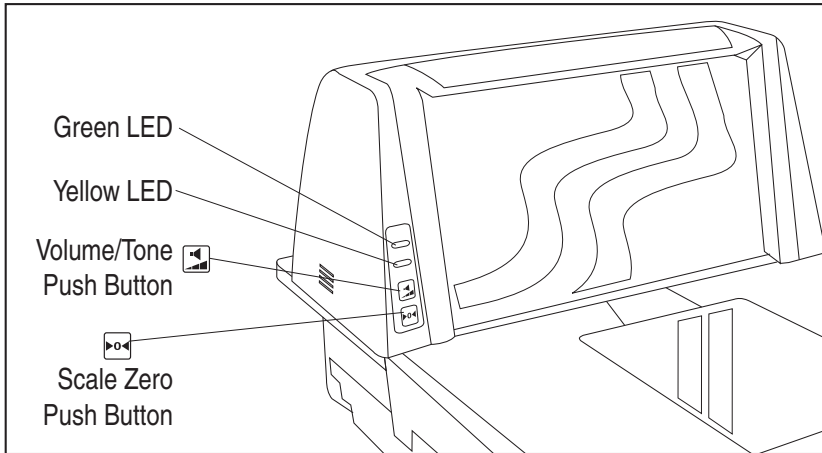









Controls and Indicators

The control panel consists of two indicator LEDs and two push buttons as described in the following pages.

Indicator LEDs

The green LED indicates scanner status, and the yellow LED is primarily used to show scale status as described in Table A-1 below:

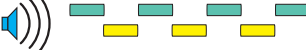
Table A-1. Green and Yellow LED Functions

LED INDICATION	DURATION	COMMENT
Scale at Zero ^a	Yellow LED on steady 	The scale is at rest and reads zero weight. The scale is ready to weigh.
Scanner Active ^a (Normal Mode)	Green LED on steady and dim 	The scanner is ready for operation. Scanning is immediately available.
Good Read Indication ^a	Green LED - bright flash 	Indicates a bar code has been read and decoded.
Program Mode Indication	Green LED - Continuous flashing 	Indicates the scanner is in Label Programming Mode. Cycle power to exit Programming Mode.
Sleep Mode Indication	Green LED blinks at a 2-second rate 	The scanner motor and/or laser have automatically switched off and the unit has entered Sleep Mode due to extended inactivity.
Host Disabled	1-second off, 1/10-second on 	Host has disabled scanning.
Field Replaceable Unit (FRU) Warning (Error Mode)	Audible low tone 3 seconds. Alternating Green/Yellow LED flashes continuously. 	Serves notice that a fatal FRU failure has been detected. Consult <i>Error Codes</i> in Section 4 for more details. If a low tone is heard, but continuous flashing is not observed, the scanner can still function in a limited capacity. Call systems support for service in either case.
FRU Indication	Green LED flashes a coded sequence in concert with the speaker. 	Occurs ONLY upon Volume/Tone button push following a FRU warning. Enables service technicians to identify FRU failures.

a. Certain functions of the Green and Yellow LEDs are selectable to be enabled or disabled. Your scanner may not be programmed to display all indications.

Volume/Tone Push Button

The Volume/Tone Push Button also performs multiple functions depending upon the duration of time it is pressed:



NOTE

Volume changes made using the Volume/Tone Push Button are lost when the scanner is powered-down and are reset to the factory default setting. If you wish to permanently change the volume, use the special programming labels in Section 6, *Programming*.



NOTE

If your scanner emits rapid clicking sounds, it may mean you've accidentally initiated an advanced diagnostic mode used by factory service technicians. To exit this mode, reset the scanner by cycling power or pressing the Volume/Tone Push Button for ten seconds or longer.

Table A-2. Volume/Tone Push Button Functions

PRESS DURATION	FUNCTION	COMMENT
Momentary (when scanner is asleep)	Wakes scanner from Sleep Mode	Alternatively, the scanner can be awakened by: <ul style="list-style-type: none"> - Moving an object through the scan zone. - A weight change on the scale. - Changing the ambient light. - Scanning with an attached auxiliary scanner.
Momentary (when scanner is awake)	Increments volume	Press the push button momentarily to increase speaker volume. When the loudest volume is reached, a repeated press of the push button cycles volume back to the lowest setting, then volume increases on subsequent press(es). Five volume levels are available.
Hold, then release when the beeper sounds	Increments tone	Press the push button for approximately 2 seconds, then release. Each time this is done, the beeper will sound at one of three tones. Stop when the desired tone (high, medium or low) is sounded.
5 Seconds	Scanner Diagnostics Mode ^a	This mode allows system support personnel to troubleshoot problems with the scanner. Upon entering Scanner Diagnostic Mode, view the 7-segment display to view Interface Type, Bootloader Version Number, Application Version Number and Configuration File Number. This mode is used to determine if a scanner can read bar codes. Press the button for eight seconds or cycle power to exit Scanner Diagnostics Mode and reset the scanner.
10 Seconds	Resets Scanner ^b	Only system support personnel should perform a reset.

- a. By standard default, this function is normally disabled to prevent accidental activation by users.
- b. Users should not perform scanner resets except under the direction of systems support personnel.

Scale Zero Push Button

The Scale Zero Push Button is used for multiple functions as listed in Table A-3.



NOTE

The Scale Zero Push Button has no function in a “scanner only” model.

Table A-3. Scale Zero Push Button Functions

PRESS DURATION	FUNCTION	COMMENT
Momentary	Zero Scale	When programmed to do so, the yellow LED should be lit when no weight is on the scale, indicating scale at zero. If it is not, press the switch to zero the scale. The unit will sound a “click” upon pressing the button.
4 Seconds	Scale Diagnostics Mode ^a	This mode allows system support personnel to troubleshoot problems with the scale. Momentarily press the Scale Zero Push Button or cycle power to exit Scale Diagnostics Mode.

- a. Diagnostics Mode is meant for use by trained systems support personnel. Users should not need to initiate this function under normal circumstances.

Calibration Switch

This switch initiates the scale’s calibration routine. A certified weight set is needed to perform the scale calibration steps detailed in Section 5, *Calibration*. This switch is not included in scanners without scale modules.

Calibration Switch Seal

This seal allows you to secure the Calibration Switch and restrict access to it. If the calibration seal is broken or missing, you may be prohibited from operating the scale without recertification. Check local and state requirements for specific restrictions.

LEGAL NOTE**LEGAL NOTE**

There are regulations that must be followed in order to ensure compliance when operating a weighing device such as the scanner/scale. Failure to observe and comply with these regulations could result in legal action.

Appendix B

Cable Information

Introduction

The following pages contain pinout information, enabling you to create standard interface cables for use in interconnecting the scanner, scale, external handheld scanner, and POS terminal.

General Specifications

Wire Requirements

- Cable length should not exceed 15 feet.
- Wire gauge = Standard for RJ-45 connectors (28-26 AWG).
- If run exceeds 15 feet, we recommend 26 AWG wire size.

RS-232 Cable Pinout

Scanner

Connector Hardware

RJ45, 10 Position

Cable Pinout

Table B-1. RS-232 Cable Pinouts

PIN #	FUNCTION	DESCRIPTION
1	+5V pullup	+5V pullup
2	CTS in	Clear To Send (input)
3	N/C	No Connection
4	RTS out	Request To Send (output)
5	RxD in	Receive Data (Input)
6	TxD out	Transmit Data (output)
7	N/C	No Connection
8	+5V out	+5V out
9	GND	Signal Ground
10	N/C	No Connection

RS-232 Cable Pinout — continued

Scale

Connector Hardware

RJ45, 10 Position

Cable Pinout

Table B-2.

PIN #	FUNCTION	DESCRIPTION
1	+5V pullup	+5V pullup
2	CTS IN	Clear To Send (input)
3	N/C	No Connection
4	RTS OUT	Request To Send (output)
5	RxD IN	Receive Data (Input)
6	TxD OUT	Transmit Data (output)
7	N/C	No Connection
8	+5V out	+5V out
9	Gnd	Signal Ground
10	N/C	No Connection

IBM Cable Pinout

Scanner and Scale

Connector Hardware

RJ45, 10 Position

Cable Pinout

Table B-3

PIN #	FUNCTION	DESCRIPTION
1	+5V pullup	+5V pullup
2	N/C	No Connection
3	N/C	No Connection
4	Serial I/O B	Serial Data -
5	N/C	No Connection
6	Serial I/O A	Serial Data +
7	N/C	No Connection
8	+5V out	+5V out
9	Ground	Signal Ground
10	N/C	No Connection

IBM USB Cable Pinout

Scanner and Scale

Connector Hardware

RJ45, 10 Position

Cable Pinout

Table B-4

PIN #	FUNCTION	DESCRIPTION
1	+5V pullup	+5V pullup
2	N/C	No Connection
3	N/C	No Connection
4	USB D-	USB D-
5	N/C	No Connection
6	USB D+	USB D+
7	N/C	No Connection
8	+5V out	+5V out
9	GND	Signal Ground
10	N/C	No Connection

Auxiliary Port

External Handheld Input

Connector Hardware

RJ45, 10 Position

Cable Pinout

Table B-5

PIN #	FUNCTION	DESCRIPTION
1	+5V pullup	+5V pullup
2	CTS in	Clear To Send (input)
3	N/C	No Connection - Reserved
4	RTS out	Request To Send (output)
5	RxD in	Receive Data (Input)
6	TxD out	Transmit Data (output)
7	N/C	No Connection
8	+5V out (500mA max)	+5V out
9	GND	Signal Ground
10	N/C	No Connection

EAS Interlock Connector

Scanner and Scale



NOTE

Antenna Connections. Connect **ONLY** using approved cables approved by the manufacturer for this product.

Connector Hardware

RJ-4

Cable Pinout

Table B-6

PIN #	SIGNAL
1	GND
2	+5V Out
3	EAS Out
4	Speaker Out ^a

- a. The "Speaker Out" line is an analog signal (5Vpp max), connected to one of the internal speaker terminals, intended to connect to an external amplifier to drive an external speaker.

Power Cable

Connector Hardware

6 pin Molex

Cable Pinout

Table B-7

PIN #	FUNCTION	DESCRIPTION
1	EARTH GND	Earth Ground
2	SIGNAL GND	Signal Ground
3	+5V IN	+5V in
4	N/C	No Connection
5	N/C	No Connection
6	+12V IN	+12V in

Remote Display

Connector Hardware

4 pin SDL

Cable Pinout

Table B-8

PIN #	FUNCTION	DESCRIPTION
1	+12V OUT	+12V out
2	LINE_A_DSPLY	LINE A Display
3	LINE_B_DSPLY	LINE B Display
4	GND	Ground

Appendix C

Keypad

Use the bar codes in this section to enter numbers and characters as you would select digits/characters from a keypad.

Scan your selection from the bar codes below. You'll need to cover any unused bar codes on this and the facing page to ensure that the scanner reads only the bar code you intend to scan.

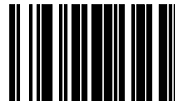

0

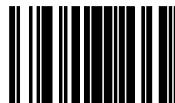

1

Use the bar codes in this section to enter numbers and characters as you would select digits/characters from a keypad.

Scan your selection from the bar codes below. You'll need to cover any unused bar codes on this and the facing page to ensure that the scanner reads only the bar code you intend to scan.



2



3

Use the bar codes in this section to enter numbers and characters as you would select digits/characters from a keypad.

Scan your selection from the bar codes below. You'll need to cover any unused bar codes on this and the facing page to ensure that the scanner reads only the bar code you intend to scan.

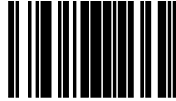

4



5

Use the bar codes in this section to enter numbers and characters as you would select digits/characters from a keypad.

Scan your selection from the bar codes below. You'll need to cover any unused bar codes on this and the facing page to ensure that the scanner reads only the bar code you intend to scan.



6

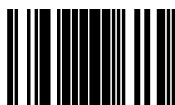

7

Use the bar codes in this section to enter numbers and characters as you would select digits/characters from a keypad.

Scan your selection from the bar codes below. You'll need to cover any unused bar codes on this and the facing page to ensure that the scanner reads only the bar code you intend to scan.



8

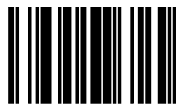

9

Use the bar codes in this section to enter numbers and characters as you would select digits/characters from a keypad.

Scan your selection from the bar codes below. You'll need to cover any unused bar codes on this and the facing page to ensure that the scanner reads only the bar code you intend to scan.

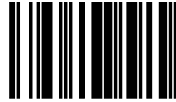

A



B

Use the bar codes in this section to enter numbers and characters as you would select digits/characters from a keypad.

Scan your selection from the bar codes below. You'll need to cover any unused bar codes on this and the facing page to ensure that the scanner reads only the bar code you intend to scan.

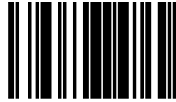

C

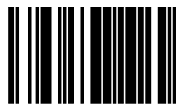

D

Use the bar codes in this section to enter numbers and characters as you would select digits/characters from a keypad.

Scan your selection from the bar codes below. You'll need to cover any unused bar codes on this and the facing page to ensure that the scanner reads only the bar code you intend to scan.

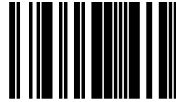

E



F

Appendix D

Host Commands

Accepting Commands from an RS-232 Scanner Host

The scanner responds to the following RS-232 commands:

COMMAND	ASCII	HEX	COMMENT
Enable Scanner	E	0x45	
Disable Scanner	D	0x44	
Reset Scanner	R	0x52	
Not On File Indication	F	0x46	Long series of beeps
Beep Good Read Tone	B	0x42	Beeps if Good Read Beep is enabled
Force Good Read Tone		0x01	Beeps regardless of beep setting
Bel		0x07	Force Good Read Tone
Identification request	i	0x69	Returns long response ^a
Health request	h	0x68	Returns long response ^a
Status request	s	0x73	Returns long response ^a

a. Call Tech Support for information.

If one of the above commands is received, the scanner will perform the steps indicated for the command. Host commands for other interfaces is also available. Contact Tech Support for more details.

NOTES

Appendix E

Factory Defaults

The following table provides a listing of the most common factory settings for the interfaces shown.

Table 5-1. Factory Default Settings

	Aux	RS-232	Wincor-Nixdorf	Single Cable	IBM 17	IBM USB
Double Read Timeout	60 (600ms)	60 (600ms)	60 (600ms)	60 (600ms)	60 (600ms)	60 (600ms)
Laser Timeout	20 (5 min.)	20 (5 min.)	20 (5 min.)	20 (5 min.)	20 (5 min.)	20 (5 min.)
Motor Timeout	40 (10 min.)	40 (10 min.)	40 (10 min.)	40 (10 min.)	40 (10 min.)	40 (10 min.)
Green LED Idle State	2 (on dim)	2 (on dim)	2 (on dim)	2 (on dim)	2 (on dim)	2 (on dim)
Scanner Button Options	1 (vol/tone/ reset)	1 (vol/tone/ reset)	1 (vol/tone/ reset)	1 (vol/tone/ reset)	1 (vol/tone/ reset)	1 (vol/tone/ reset)
Power-up Beep Control	1 beep	1 beep	1 beep	1 beep	1 beep	1 beep
Good Read Beep Control	1 (enable)	1 (enable)	1 (enable)	1 (enable)	1 (enable)	1 (enable)
Good Read Beep Frequency	1 (medium)	1 (medium)	1 (medium)	1 (medium)	1 (medium)	1 (medium)
Good Read Beep Length	8 (80ms)	8 (80ms)	8 (80ms)	8 (80ms)	8 (80ms)	8 (80ms)
Good Read Beep Volume	3 (med-high)	3 (med-high)	3 (med-high)	3 (med-high)	3 (med-high)	3 (med-high)
Good Read When to Indicate	0 (after decode)	0 (after decode)	0 (after decode)	0 (after decode)	0 (after decode)	0 (after decode)
Scale Enable	0 (disable)	1 (enable)	0 (disable)	1 (enable)	1 (enable)	1 (enable)
Scale Country Mode	0 (US)	0 (US)	0 (US)	0 (US)	0 (US)	0 (US)

	Aux	RS-232	Wincor-Nixdorf	Single Cable	IBM 17	IBM USB
Scale Enforced Zero Return	0 (disable)	0 (disable)	0 (disable)	0 (disable)	0 (disable)	0 (disable)
Scale Interface Type	4 (RS-232 SASI)	4 (RS-232 SASI)	4 (RS-232 SASI)	7 (RS-232 single cable)	1 (IBM Port 17)	3 (IBM USB)
Scale Motion Level Filter	0 (low)	0 (low)	0 (low)	0 (low)	0 (low)	0 (low)
Scale LED Enable	1 (enable)	1 (enable)	1 (enable)	1 (enable)	1 (enable)	1 (enable)
Remote Display — Enable/Disable	1 (enable)	1 (enable)	1 (enable)	1 (enable)	1 (enable)	1 (enable)
EAS Active State	0 (active low)	0 (active low)	0 (active low)	0 (active low)	0 (active low)	0 (active low)
EAS Timeout	2 (20ms)	2 (20ms)	2 (20ms)	2 (20ms)	2 (20ms)	2 (20ms)
Aux Port Mode	0 (disable)	0 (disable)	0 (disable)	0 (disable)	0 (disable)	0 (disable)
Productivity Index Reporting (PIR)	0 (disable)	0 (disable)	0 (disable)	0 (disable)	0 (disable)	0 (disable)
Maximum Host-Transmitted Message Length	0 (no limit)	0 (no limit)	0 (no limit)	0 (no limit)	0 (no limit)	0 (no limit)
Number of Host Transmission Buffers	1 (2 buffers)	1 (2 buffers)	1 (2 buffers)	1 (2 buffers)	0 (1 buffer)	0 (1 buffer)
Global Prefix	(")	(")	(")	(")		
Global Suffix	0D00 ("0D")	0D00 ("0D")	0D00(")")	(")		
IBM Scale Address					110	
IBM Transmit Labels in Code 39 Format					0 (disable)	
IBM USB Scanner Device Type						0 (fixed scanner)
RS-232 Baud Rate	0 (19200)	1 (9600)	1 (9600)	1 (9600)		

	Aux	RS-232	Wincor-Nixdorf	Single Cable	IBM 17	IBM USB
RS-232 Number of Data Bits	1 (8 data bits)	1 (8 data bits)	1 (8 data bits)	0 (7 data bits)		
RS-232 Number of Stop Bits	0 (1 stop bit)	0 (1 stop bit)	0 (1 stop bit)	0 (1 stop bit)		
RS-232 Parity	0 (none)	0 (none)	2 (odd)	2 (odd)		
RS-232 Hardware Control	0 (disable)	0 (disable)	1 (enable CTS flow)			
RS-232 Intercharacter Delay	0 (none)	0 (none)	0 (none)			
RS-232 Software Flow Control	0 (disable)	0 (disable)	0 (disable)	0 (disable)		
RS-232 Host Echo		0 (disable)	0 (disable)			
RS-232 Host Echo Quiet Interval	1 (10ms)	1 (10ms)				
RS-232 Ignore Host Commands	0 (disable)	0 (disable)	0 (disable)	0 (disable)	0 (disable)	0 (disable)
RS-232 TTL		0 (normal RS-232)	0 (normal RS-232)			
RS-232 TTL Invert	0 (disable)	0 (disable)				
RS-232 Beep on ASCII BEL	0 (disable)	0 (disable)	0 (disable)			
RS-232 Beep After Weigh	1 (enable)	1 (enable)	0 (disable)	1 (enable)		
RS-232 Beep on Not on File	1 (enable)	1 (enable)	1 (enable)	1 (enable)		
RS-232 ACK NAK Enable	0 (disable)	0 (disable)	0 (disable)			
RS-232 ACK Character	6 (ACK)	6 (ACK)	6 (ACK)			
RS-232 NAK Character	21 (NAK)	21 (NAK)	21 (NAK)			

	Aux	RS-232	Wincor-Nixdorf	Single Cable	IBM 17	IBM USB
RS-232 Retry on ACK NAK Timeout	1 (enable)	1 (enable)	1 (enable)			
RS-232 ACK NAK Timeout Value	1 (200ms)	1 (200ms)	1 (200ms)			
RS-232 ACK NAK Retry Count	3 resets	3 resets	3 resets			
RS-232 ACK NAK Error Handling	0 (ignore errors)	0 (ignore errors)	0 (ignore errors)			
RS-232 Label ID Control	1 (enable as prefix)	1 (enable as prefix)	1 (enable as prefix)	1 (enable as prefix)		
Single Cable RS-232 Scanner Only Protocol		0 (scanner-scale)				
Single Cable RS-232 RTS CTS Selection				Option 5		
Single Cable RS-232 Use BCC			0 (disable)			
Single Cable RS-232 Use ACK/NAK			0 (disable)			
Single Cable RS-232 Use STX			1 (enable)			
Set Single Cable RS-232 STX Character				83 (S)		
Single Cable RS-232 Use ETX			1 (enable)			
Set Single Cable RS-232 ETX Character				13 (CR)		
Single Cable RS-232 Datalogic Extensions				0 (std protocol)		
UPC-A Enable	1 (enable)	1 (enable)	1 (enable)	1 (enable)	1 (enable)	1 (enable)

	Aux	RS-232	Wincor-Nixdorf	Single Cable	IBM 17	IBM USB
UPC-A Number System Character Transmission	0 (disable)	1 (enable)	1 (enable)	1 (enable)	1 (enable)	1 (enable)
UPC-A Check Character Transmission	1 (enable)	1 (enable)	1 (enable)	0 (disable)	1 (enable)	1 (enable)
Expand UPC-A to EAN-13	0 (disable)	0 (disable)	1 (enable)	0 (disable)	0 (disable)	0 (disable)
UPC/EAN AIM ID	0 (disable)	0 (disable)	0 (disable)			
UPC-A Label ID	4100("A")	4100("A")	4100("A")	4100("A")		
UPC-A 2-Digit Supplemental Label ID	4100("A")	4100("A")	4100("A")	4100("A")		
UPC-A 5-Digit Supplemental Label ID	4100("A")	4100("A")	4100("A")	4100("A")		
UPC-A 128 Supplemental Label ID	4100("A")	4100("A")	4100("A")	4100("A")		
UPC-E Enable	1 (enable)	1 (enable)	1 (enable)	1 (enable)	1 (enable)	1 (enable)
UPC-E Number System Character Transmission	1 (enable)	1 (enable)	1 (enable)	1 (enable)	1 (enable)	1 (enable)
UPC-E Check Character Transmission	0 (disable)	0 (disable)	0 (disable)	0 (disable)	1 (enable)	1 (enable)
Expand UPC-E to UPC-A	0 (disable)	0 (disable)	0 (disable)	0 (disable)	0 (disable)	0 (disable)
Expand UPC-E to EAN-13	0 (disable)	0 (disable)	0 (disable)	0 (disable)	0 (disable)	0 (disable)
UPC-E Label ID	4500("E")	4500("E")	4300("C")	4500("E")		
UPC-E 2-Digit Supplemental Label ID	4500("E")	4500("E")	4300("C")	4500("E")		
UPC-E 5-Digit Supplemental Label ID	4500("E")	4500("E")	4300("C")	4500("E")		

	Aux	RS-232	Wincor-Nixdorf	Single Cable	IBM 17	IBM USB
UPC-E 128 Supplemental Label ID	4500("E")	4500("E")	4300("C")	4500("E")		
EAN-13 Enable	1 (enable)	1 (enable)	1 (enable)	1 (enable)	1 (enable)	1 (enable)
EAN-13 First Character Transmission	1 (enable)	1 (enable)	1 (enable)	1 (enable)	1 (enable)	1 (enable)
EAN-13 Check Character Transmission	1 (enable)	1 (enable)	1 (enable)	0 (disable)	1 (enable)	1 (enable)
EAN-13 ISBN Conversion Enable	0 (disable)	0 (disable)	0 (disable)	0 (disable)	0 (disable)	0 (disable)
EAN 13 Label ID	4600("F")	4600("F")	4100("A")	4600("F")		
EAN-13 2-Digit Supplemental Label ID	4600("F")	4600("F")	4100("A")	4600("F")		
EAN-13 5-Digit Supplemental Label ID	4600("F")	4600("F")	4100("A")	4600("F")		
EAN-13 128 Supplemental Label ID	4600("F")	4600("F")	4100("A")	4600("F")		
Bookland AIM ID	0 (disable)	0 (disable)	0 (disable)			
Bookland Label ID	4900 ("I")	4900 ("I")	4100 ("A")	4900 ("I")		
EAN-8 Enable	1 (enable)	1 (enable)	1 (enable)	1 (enable)	1 (enable)	1 (enable)
EAN-8 Check Character Transmission	1 (enable)	1 (enable)	1 (enable)	0 (disable)	1 (enable)	1 (enable)
Expand EAN-8 to EAN-13	0 (disable)	0 (disable)	0 (disable)	0 (disable)	0 (disable)	0 (disable)
EAN 8 Label ID	4646 ("FF")	4646 ("FF")	4200 ("B")	4646 ("FF")		
EAN-8 2-Digit Supplemental Label ID	4646 ("FF")	4646 ("FF")	4200 ("B")	4646 ("FF")		
EAN-8 5-Digit Supplemental Label ID	4646 ("FF")	4646 ("FF")	4200 ("B")	4646 ("FF")		

	Aux	RS-232	Wincor-Nixdorf	Single Cable	IBM 17	IBM USB
EAN-8 128 Supplemental Label ID	4646 ("FF")	4646 ("FF")	4200 ("B")	4646 ("FF")		
EAN-8 Decoding Levels	1 (Very Conservative)	1 (Very Conservative)	1 (Very Conservative)	1 (Very Conservative)	1 (Very Conservative)	1 (Very Conservative)
UPC/EAN Reconstruction	0 (disable)	0 (disable)	0 (disable)	0 (disable)	0 (disable)	0 (disable)
Price Weight Check	0 (disable)	0 (disable)	0 (disable)	0 (disable)	0 (disable)	0 (disable)
Enable EAN Two Label	0 (disable)	0 (disable)	0 (disable)	0 (disable)	0 (disable)	0 (disable)
Addons	Disable All	Disable All	Disable All	Disable All	Disable All	Disable All
UPC-A and EAN-13 Decoding Levels	2 (Slightly More Aggressive)	2 (Slightly More Aggressive)	2 (Slightly More Aggressive)	2 (Slightly More Aggressive)	2 (Slightly More Aggressive)	2 (Slightly More Aggressive)
RSS-14 Enable	0 (disable)	0 (disable)	0 (disable)	0 (disable)	0 (disable)	0 (disable)
RSS-14 Check Character Transmission	1 (enable)	1 (enable)	1 (enable)	1 (enable)	1 (enable)	1 (enable)
RSS-14/EAN-128 Emulation	0 (disable)	0 (disable)	0 (disable)	0 (disable)	0 (disable)	0 (disable)
RSS-14 2D Component Enable	0 (disable)	0 (disable)	0 (disable)	0 (disable)	0 (disable)	0 (disable)
RSS-14 AIM ID	0 (disable)	0 (disable)	0 (disable)			
RSS-14 Label ID	5234 ("R4")	5234 ("R4")	4500 ("E")	5234 ("R4")		
RSS Expanded Enable	0 (disable)	0 (disable)	0 (disable)	0 (disable)	0 (disable)	0 (disable)
RSS Expanded EAN-128 Emulation	0 (disable)	0 (disable)	0 (disable)	0 (disable)	0 (disable)	0 (disable)
RSS Expanded 2D Component Enable	0 (disable)	0 (disable)	0 (disable)	0 (disable)	0 (disable)	0 (disable)
RSS Expanded AIM ID	0 (disable)	0 (disable)	0 (disable)			

	Aux	RS-232	Wincor-Nixdorf	Single Cable	IBM 17	IBM USB
RSS Expanded Label ID	5258 ("RX")	5258 ("RX")	4500 ("E")	5258 ("RX")		
RSS Expanded Length Control	0 (variable)	0 (variable)	0 (variable)	0 (variable)	0 (variable)	0 (variable)
RSS Expanded Maximum Label Length	74	74	74	74	74	74
RSS Expanded Minimum Label Length	1	1	1	1	1	1
RSS Expanded Fixed Length 1	8	8	8	8	8	8
RSS Expanded Fixed Length 2	14	14	14	14	14	14
Code 39 Enable	1 (enable)	1 (enable)	0 (disable)	1 (enable)	1 (enable)	1 (enable)
Code 39 Start Stop Character Transmission	0 (disable)	0 (disable)	0 (disable)	0 (disable)	0 (disable)	0 (disable)
Code 39 Check Character Calculation	0 (disable)	0 (disable)	0 (disable)	0 (disable)	0 (disable)	0 (disable)
Code 39 Check Character Transmission	1 (enable)	1 (enable)	1 (enable)	1 (enable)	1 (enable)	1 (enable)
Code 39 Full ASCII	0 (disable)	0 (disable)	0 (disable)	0 (disable)	0 (disable)	0 (disable)
Code 39 AIM ID	0 (disable)	0 (disable)	0 (disable)			
Code 39 Label ID	2A00 ("**")	2A00 ("**")	4D00 ("M")	4231 ("B1")		
Code 39 Length Control	0 (variable)	0 (variable)	0 (variable)	0 (variable)	0 (variable)	0 (variable)
Code 39 Maximum Label Length	50	50	50	50	50	50
Code 39 Minimum Label Length	2	2	2	2	2	2

	Aux	RS-232	Wincor-Nixdorf	Single Cable	IBM 17	IBM USB
Code 39 Fixed Length 1	8	8	8	8	8	8
Code 39 Fixed Length 2	14	14	14	14	14	14
Code 39 Stitching	1 (enable)	1 (enable)	1 (enable)	1 (enable)	1 (enable)	1 (enable)
Pharmacode 39 Enable	1 (enable)	0 (disable)	0 (disable)	0 (disable)	0 (disable)	0 (disable)
Pharmacode 39 Start Stop Character Transmission	0 (disable)	0 (disable)	0 (disable)	0 (disable)	0 (disable)	0 (disable)
Pharmacode 39 Check Character Transmission	1 (enable)	1 (enable)	1 (enable)	1 (enable)	1 (enable)	
Pharmacode 39 Label ID	4100("A")	4100("A")	4100("A")	4100("A")		
Code 128 Enable	1 (enable)	1 (enable)	0 (disable)	1 (enable)	1 (enable)	1 (enable)
Code 128 Transmit Function Characters	0 (disable)	0 (disable)	0 (disable)	0 (disable)	0 (disable)	0 (disable)
Convert Code 128 to Code 39	0 (disable)	0 (disable)	0 (disable)	0 (disable)	0 (disable)	0 (disable)
Code 128 AIM ID	0 (disable)	0 (disable)	0 (disable)			
Code 128 Label ID	2300 ("#")	2300 ("#")	4B00 ("K")	4233 ("B3")		
Code 128 Length Control	0 (variable)	0 (variable)	0 (variable)	0 (variable)	0 (variable)	0 (variable)
Code 128 Maximum Label Length	80	80	80	80	80	80
Code 128 Minimum Label Length	2	2	2	2	2	2
Code 128 Fixed Length 1	8	8	8	8	8	8
Code 128 Fixed Length 2	14	14	14	14	14	14

	Aux	RS-232	Wincor-Nixdorf	Single Cable	IBM 17	IBM USB
Code 128 Stitching	1 (enable)	1 (enable)	1 (enable)	1 (enable)	1 (enable)	1 (enable)
EAN-128 Enable	0 (disable)	0 (disable)	0 (disable)	0 (disable)	0 (disable)	0 (disable)
EAN 128 AIM ID	1 (enable)	1 (enable)	0 (disable)			
EAN 128 Label ID	0000 ("")	0000 ("")	5000 ("P")	0000 ("")		
Interleaved 2 of 5 (I 2 OF 5) Enable	0 (disable)	0 (disable)	0 (disable)	0 (disable)	0 (disable)	0 (disable)
I 2 of 5 Check Character Calculation	0 (disable)	0 (disable)	0 (disable)	0 (disable)	0 (disable)	0 (disable)
I 2 of 5 Check Character Transmission	1 (enable)	1 (enable)	1 (enable)	1 (enable)	1 (enable)	1 (enable)
I 2 of 5 AIM ID	0 (disable)	0 (disable)	0 (disable)			
I 2 of 5 Label ID	6900 ("i")	6900 ("i")	4900 ("l")	4232 ("B2")		
I 2 of 5 Length Control	0 (variable)	0 (variable)	0 (variable)	0 (variable)	0 (variable)	0 (variable)
I 2 of 5 Maximum Label Length	50	50	50	50	50	50
I 2 of 5 Minimum Label Length	6	6	6	6	6	6
I 2 of 5 Fixed Length 1	10	10	10	10	10	10
I 2 of 5 Fixed Length 2	0	0	0	0	0	0
I 2 of 5 Stitching	0 (disable)	0 (disable)	0 (disable)	0 (disable)	0 (disable)	0 (disable)
Codabar Enable	0 (disable)	0 (disable)	0 (disable)	0 (disable)	0 (disable)	0 (disable)
Codabar Start Stop Character Transmission	0 (disable)	0 (disable)	1 (enable)	0 (disable)	0 (disable)	0 (disable)
Codabar Start Stop Character Set	3 (abcd/abcd)	3 (abcd/abcd)	3 (abcd/abcd)	3 (abcd/abcd)	3 (abcd/abcd)	3 (abcd/abcd)

	Aux	RS-232	Wincor-Nixdorf	Single Cable	IBM 17	IBM USB
Codabar Start Stop Character Match	0 (disable)	0 (disable)	0 (disable)	0 (disable)	0 (disable)	0 (disable)
Codabar Check Character Calculation	0 (disable)	0 (disable)	0 (disable)	0 (disable)	0 (disable)	0 (disable)
Codabar Check Character Transmission	1 (enable)	1 (enable)	1 (enable)	1 (enable)	1 (enable)	1 (enable)
Codabar AIM ID	0 (disable)	0 (disable)	0 (disable)			
Codabar Label ID	2500 ("%")	2500 ("%")	4E00 ("N")	2500 ("%")		
Codabar Length Control	0 (variable)	0 (variable)	0 (variable)	0 (variable)	0 (variable)	0 (variable)
Codabar Maximum Label Length	50	50	50	50	50	50
Codabar Minimum Label Length	8	8	8	8	8	8
Codabar Fixed Length 1	8	8	8	8	8	8
Codabar Fixed Length 2	14	14	14	14	14	14
Codabar Stitching	0 (disable)	0 (disable)	0 (disable)	0 (disable)	0 (disable)	0 (disable)
Code 93 Enable	0 (disable)	0 (disable)	0 (disable)	0 (disable)	0 (disable)	0 (disable)
Code 93 AIM ID	0 (disable)	0 (disable)	0 (disable)			
Code 93 Label ID	2600 ("&")	2600 ("&")	4C00 ("L")	2600 ("&")		
Code 93 Length Control	0 (variable)	0 (variable)	0 (variable)	0 (variable)	0 (variable)	0 (variable)
Code 93 Maximum Label Length	50	50	50	50	50	50
Code 93 Minimum Label Length	2	2	2	2	2	2
Code 93 Fixed Length 1	8	8	8	8	8	8
Code 93 Fixed Length 2	14	14	14	14	14	14

	Aux	RS-232	Wincor-Nixdorf	Single Cable	IBM 17	IBM USB
Code 93 Stitching	1 (enable)	1 (enable)	1 (enable)	1 (enable)	1 (enable)	1 (enable)
MSI/Plessey Enable	0 (disable)	0 (disable)	0 (disable)	0 (disable)		
MSI/Plessey Check Character Calculation	1 (enable)	1 (enable)	1 (enable)	1 (enable)		
MSI/Plessey Number of Check Characters	0 (1 check char)	0 (1 check char)	0 (1 check char)	0 (1 check char)		
MSI/Plessey Check Character Transmission	1 (enable)	1 (enable)	1 (enable)	1 (enable)		
MSI/Plessey AIM ID	0 (disable)	0 (disable)	0 (disable)			
MSI/Plessey Label ID	4000 ("@")	4000 ("@")	4F00 ("O")	4000 ("@")		
MSI/Plessey Length Control	0 (variable)	0 (variable)	0 (variable)	0 (variable)		
MSI/Plessey Maximum Label Length	16	16	16	16		
MSI/Plessey Minimum Label Length	4	4	4	4		
MSI/Plessey Fixed Length 1	7	7	7	7		
MSI/Plessey Fixed Length 2	8	8	8	8		
MSI/Plessey Stitching	0 (disable)	0 (disable)	0 (disable)	0 (disable)		
Standard 2 of 5 Enable	0 (disable)	0 (disable)	0 (disable)	0 (disable)	0 (disable)	0 (disable)
Standard 2 of 5 Check Character Calculation	0 (disable)	0 (disable)	0 (disable)	0 (disable)	0 (disable)	0 (disable)
Standard 2 of 5 Check Character Transmission	1 (enable)	1 (enable)	1 (enable)	1 (enable)	1 (enable)	1 (enable)
Standard 2 of 5 AIM ID	0 (disable)	0 (disable)	0 (disable)	0 (disable)	0 (disable)	0 (disable)

	Aux	RS-232	Wincor-Nixdorf	Single Cable	IBM 17	IBM USB
Standard 2 of 5 Label ID	5300 ("S")	5300 ("S")	5300 ("S")	5300 ("S")	5300 ("S")	5300 ("S")
Standard 2 of 5 Length Control	0 (variable)	0 (variable)	0 (variable)	0 (variable)	0 (variable)	0 (variable)
Standard 2 of 5 Maximum Label Length	50	50	50	50	50	50
Standard 2 of 5 Minimum Label Length	6	6	6	6	6	6
Standard 2 of 5 Fixed Length 1	10	10	10	10	10	10
Standard 2 of 5 Fixed Length 2	0	0	0	0	0	0
Standard 2 of 5 Stitching	0 (disable)	0 (disable)	0 (disable)	0 (disable)	0 (disable)	0 (disable)

NOTES

Appendix F

Handheld Data Format Requirements

This appendix provides application notes to describe the general format of data that can be accepted by the scanner through the auxiliary port as transmitted from a handheld scanner.

Handheld Data Format Requirements General

- 9600 bps, 8 data bits, 1 stop bit, 1 parity.
- RTS is used to "bracket" the data received from the handheld: RTS must be asserted high during data transmission, and de-asserted after label transmission is complete. No other flow control mechanisms are required or supported.
- Symbologies requiring fixed lengths (UPC/EAN) will enforce length requirements for validation of the label.
- Handheld will be required to transmit start and stop characters for Codabar and Code 39 labels.
- Appropriate industrial length requirements will be enforced (if configured) for validation of the label.
- Maximum label lengths will be enforced for label validation (i.e. labels longer than the maximum label size will not be validated).
- Standard Datalogic formats generally use a single prefix character. The specific formats are provided below.

Datalogic Handheld Data Format Requirements

The following sections describe label transmission formats that are typically observed in factory configurations of Datalogic handheld scanners.

RSS-14

- Prefix must be ASCII characters 'R4'
- Check character must be included in label
- Application identifier "01" must follow the prefix and precede the base label
- Label length excluding prefix characters must be 16 characters.
- Example: 'R40101044123456789'

RSS Expanded

- Prefix must be ASCII characters 'R4'
- Check character must be included in label

UPC-A

- Number system must be included in label data.
- Check digit must be included in label data and is assumed to be correct.
- Prefix must be an ASCII character 'A' - total length including prefix must be 13.
- Example: 'A060992011187'.

UPC-A with 2-Digit Supplemental

- Number system must be included in label data.
- Check digit must be included in label data and is assumed to be correct.
- Supplemental data is appended to base label.
- Prefix must be an ASCII character 'A' - total length including prefix must be 15.
- Example: 'A06099201118712'.

UPC-A with 5-Digit Supplemental

- Number system must be included in label data.
- Check digit must be included in label data and is assumed to be correct.
- Prefix must be an ASCII character 'A' - total length including prefix must be 18.
- Example: 'A06099201118712345'.

UPC-A with Code 128 Supplemental

- Number system must be included in label data.
- Check digit must be included in label data and is assumed to be correct.
- Supplemental data is appended to base label.
- Prefix must be an ASCII character 'A' - total length including prefix must be greater or equal to 19 Code 128 Supplemental codes are variable length having a minimum of 2 data characters).
- Characters immediately following base label must be of the form '8100', '8101' or '8102'.
- Example: 'A0609920111878100000951'.

UPC-E

- Number system must be included in label data.
- Check digit must be included in label data and is assumed to be correct.
- Prefix must be an ASCII character 'E' - total length including prefix must be 9.
- Example: 'E09988750'.

UPC-E with 2-Digit Supplemental

- Number system must be included in label data.
- Check digit must be included in label data and is assumed to be correct.
- Supplemental data is appended to base label.
- Prefix must be an ASCII character 'E' - total length including prefix must be 11.
- Example: 'E0998875012'.

UPC-E with 5-Digit Supplemental

- Number system must be included in label data.
- Check digit must be included in label data and is assumed to be correct.
- Prefix must be an ASCII character 'E' - total length including prefix must be 14.
- Example: 'E0998875012345'.

UPC-E with Code 128 Supplemental

- Number system must be included in label data.
- Check digit must be included in label data and is assumed to be correct.
- Supplemental data is appended to base label.
- Prefix must be an ASCII character 'E' - total length including prefix must be greater or equal to 15 (code 128 Supplemental codes are variable length having a minimum of 2 data characters).
- Characters immediately following base label must be of the form '8100', '8101' or '8102'.
- Example: 'E099887508101000951'.

EAN-8

- Check digit must be included in label data and is assumed to be correct.
- Prefix must be an ASCII characters 'FF' - total length including prefix must be 10.
- Example: 'FF00210126'.

EAN-8 with 2-Digit Supplemental

- Check digit must be included in label data and is assumed to be correct.
- Supplemental data is appended to base label.
- Prefix must be an ASCII characters 'FF' - total length including prefix must be 12.
- Example: 'FF0021012612'.

EAN-8 with 5-Digit Supplemental

- Check digit must be included in label data and is assumed to be correct.
- Prefix must be an ASCII characters 'FF' - total length including prefix must be 15.
- Example: 'FF0021012612345'.

EAN-8 with Code 128 Supplemental

- Check digit must be included in label data and is assumed to be correct.
- Supplemental data is appended to base label.
- Prefix must be an ASCII characters 'FF' - total length including prefix must be greater than 16 (code 128 Supplemental codes are variable length having a minimum of 2 data characters).
- Characters immediately following base label must be of the form '8100', '8101' or '8102'.
- Example: 'FF002101268102000951'.

EAN-13

- Check digit must be included in label data and is assumed to be correct.
- Prefix must be an ASCII character 'F'- total length including prefix must be 14.
- Example: 'F1101234567891'.

EAN-13 with 2-Digit Supplemental

- Check digit must be included in label data and is assumed to be correct.
- Supplemental data is appended to base label.
- Prefix must be an ASCII character 'F'- total length including prefix must be 16.
- Example: 'F110123456789112'.

EAN-13 with 5-Digit Supplemental

- Check digit must be included in label data and is assumed to be correct.
- Prefix must be an ASCII character 'F'- total length including prefix must be 19.
- Example: 'F110123456789112345'.

EAN-13 with Code 128 Supplemental

- Check digit must be included in label data and is assumed to be correct.
- Supplemental data is appended to base label.
- Prefix must be an ASCII character 'F'- total length including prefix must be greater or equal to 20 (code 128 Supplemental codes are variable length having a minimum of 2 data characters).
- Characters immediately following base label must be of the form '8100', '8101' or '8102'.
- Example: 'F11012345678918100000951'.

Code 39

- Check character must be included in label data.
- Label length including start, stop and check characters and excluding prefix character must meet requirements imposed by the main scanner's fixed or variable label length control for this symbology type.
- Start and stop characters "*" must be included in label.
- Prefix must be an ASCII character '*'.
- Example : '**Code 39.TEST*'.

Code 39-Pharmacode

- Check character must be included in label data.
- Label length including start, stop and check characters and excluding prefix character must meet requirements imposed by the main scanner's fixed or variable label length control for this symbology type.
- Start and stop characters "*" must be included in label.
- Prefix must be an ASCII character 'p'.
- Example: 'p*123456789*'.

I 2 of 5

- Check character must be included in label data.
- Label length including check characters and excluding prefix character must meet requirements imposed by the main scanner's fixed or variable label length control for this symbology type.
- Prefix must be an ASCII character 'i'.
- Example: 'i0123456789'.

Codabar

- Check character must be included in label data.
- Label length including check character and excluding prefix character must meet requirements imposed by the main scanner's fixed or variable label length control for this symbology type.
- Prefix must be an ASCII character '%'.
• Start stop character sets must meet the matching requirement set forth by the scanner configuration item *Codabar Start Stop Character Match*.
- Start stop character sets must be of the form ABCD/ABCD and must be included in the label.
- Example: '%s\$99.95s' (the lower case 's' at each end of the example is a placeholder for the start stop character set).

Code 128

- Prefix must be an ASCII character '#'.
• Label length excluding prefix character must meet requirements imposed by the main scanner's fixed or variable label length control for this symbology type.
- Function characters may be transmitted as a hexadecimal value 8x. Where x correlates to function characters 1 thru 4 as follows:
 - x80 = function code 1
 - x81 = function code 2
 - x82 = function code 3
 - x83 = function code 4
- For Code 128 programming labels the format is of the general form '#/82nnnnn/r ' - /82 is hexadecimal 82 and /r is carriage return.
- Example: '#Code_128.Test'.

MSI/Plessey

- Check character must be included in label data.
- Label length including check character and excluding prefix character must meet requirements imposed by the main scanner's fixed or variable label length control for this symbology type.
- Prefix must be an ASCII character '@'.
- Example: '@144769254'.

Code 93

- Prefix must be an ASCII character '&'.
- Label length excluding prefix character must meet requirements imposed by the main scanner's fixed or variable label length control for this symbology type.
- Example: '&Code93-test'.

PDF417

- Prefix must be an ASCII character 'P'.
- Label length excluding prefix character cannot exceed 300 characters. In addition to this, label length excluding prefix character must meet requirements imposed by the main scanner's fixed or variable label length control for this symbology type.

AIM Formats

AIM specifies a 3-character string that is attached as a prefix to the label data for transmission. Because AIM specifies one identifier for UPC-A, UPC-E and EAN-13 labels, UPC-A, UPC-E and EAN-13 will be received from the handheld and transmitted by the scanner as EAN-13. The ']' character must be the first character received in the label transmission from the handheld.

The following sections describe the prefix strings and identify what specific label characteristics can be supported.

UPC-A

- AIM does not specify UPC-A as a separate symbology using this transmission format - labels will be transmitted as EAN-13.
- Example: ']E00060992011187'.

UPC-E

- AIM does not specify UPC-E as a separate symbology using this transmission format - labels will be transmitted as EAN-13.
- Example: ']E00000000998875'.

EAN-13

- Check digit must be included in label data and is assumed to be correct.
- Prefix must be ASCII characters ']E0' - total length including prefix must be 16.
- Example: ']E01101234567891'.

EAN-8

- Check digit must be included in label data and is assumed to be correct.
- Prefix must be ASCII characters ']E4' - total length including prefix must be 11.
- Example: ']E400210126'.

2-Digit Supplemental

- Supplemental data is appended to any EAN base label.
- Prefix must be ASCII characters 'J'E1'.
- length of Supplemental data including prefix must be 5. Total required length is 21 for EAN-13 and 16 for EAN-8.
- Examples: addon portion is bolded, data is underlined.

UPC-A 2-Digit addon	'J'E00060992011187J E112 '
UPC-E 2-Digit addon	'J'E00000000998875J E112 '
EAN-8 2-Digit addon	'J'E400210126J E112 '
EAN-13 2-Digit addon	'J'E01101234567891J E112 '

5-Digit Supplemental

- Supplemental data is appended to any EAN base label.
- Prefix must be ASCII characters 'J'E2'.
- Length of supplemental data including prefix must be 8. Total required length is 24 for EAN-13 and 19 for EAN-8.
- Examples: addon portion is bolded, data is underlined.

UPC-A 5-Digit addon	'J'E00060992011187J E212345 '
UPC-E 5-Digit addon	'J'E00000000998875J E212345 '
EAN-8 5-Digit addon	'J'E400210126J E212345 '
EAN-13 5-Digit addon	'J'E01101234567891J E212345 '

Code 128 Supplemental

- Supplemental data is appended to any EAN base label.
- Prefix must be ASCII characters ']C0'.
- length of Supplemental data including prefix is variable but must be at least 9.
- Examples: addon portion is bolded, data is underlined.

UPC-A Code 128 addon	']E00060992011187] C08100000951 '
UPC-E Code 128 addon	']E00000000998875] C08100000951 '
EAN-8 Code 128 addon	']E400210126] C08100000951 '
EAN-13 Code 128 addon	']E01101234567891] C08100000951 '

Bookland

- The 'Bookland' / ISBN code will be formatted as a vendor specific AIM label.
- Length of label data including prefix is 13.
- Examples: ']X01234567890'.

Code 39

- Check character must be included in label data.
- Label length including start, stop and check characters and excluding prefix characters must meet requirements imposed by the main scanner's fixed or variable label length control for this symbology type.
- Start and stop characters "*" must be included in label.
- Prefix must be ASCII characters ']A0' or ']A1'.
- Example: '*]A0Code 39.TEST*'

Codabar

- Check character must be included in label data.
- Label length including check character and excluding prefix characters must meet requirements imposed by the main scanner's fixed or variable label length control for this symbology type.
- Prefix must be ASCII characters ']F0'.
- Start stop character sets must meet the matching requirement set forth by the scanner configuration item *Codabar Start Stop Character Match*.
- Start stop character sets *s* must be of the form ABCD/ABCD and must be included in the label.
- Example: ']F0s\$99.95s' (the lower case 's' at each end of the example is a placeholder for the start stop character set).

MSI/Plessey

- Check character must be included in label data.
- Label length including check character and excluding prefix characters must meet requirements imposed by the main scanner's fixed or variable label length control for this symbology type.
- Prefix must be ASCII characters ']M0'.
- Example: ']M0144769254'.

Code 93

- Prefix must be ASCII characters ']G0'.
- Label length excluding prefix characters must meet requirements imposed by the main scanner's fixed or variable label length control for this symbology type.
- Example : ']G0Code93-test'.

RSS-14

- Prefix must be ASCII characters ']e0'.
- Check character must be included in label.
- Label length excluding prefix characters must be 14 characters.
- Example: ']e001044123456789'.

RSS Expanded

- Prefix must be ASCII characters ']e0'.
- Label length excluding prefix characters must be at least 1 character. Maximum length is the maximum label size supported by the scanner.
- Example: ']e001900123456789083103001750'.

I 2 of 5

- Check character must be included in label data.
- Label length including check characters and excluding prefix characters must meet requirements imposed by the main scanner's fixed or variable label length control for this symbology type.
- Prefix must be an ASCII character ']I1' (other prefixes specify different check character properties which are not supported).
- Example: ']I10123456789'.

Code 128 / EAN128

- Prefix must be either ASCII characters ']C0', ']C1' or ']C2'.
- Label length excluding prefix character must meet requirements imposed by the main scanner's fixed or variable label length control for this symbology type.
- If EAN-128 Symbology is Enabled and prefix is ']C1', label will be identified as an EAN128 otherwise it is identified as a Code 128.
- A prefix of ']C0' designates that no function code is present in the 1st or 2nd character position.
- A prefix of ']C2' designates that a function code 1 is present in the 2nd character.
- Example : ']C0Code_128.Test'.

PDF417

- Prefix must be an ASCII characters ']L0'.
- Label length excluding prefix character cannot exceed 300 characters. In addition to this, label length excluding prefix character must meet requirements imposed by the main scanner's fixed or variable label length control for this symbology type.
- Example : ']L0pdf_test_label'.

NOTES

NOTES

NOTES

Index

(Short Pedestal Base ONLY)	2-26	Code 128 Enable	6-198
2-Digit Supplemental	F-11	Code 128 Fixed Length 1	6-206
5-Digit Supplemental	F-11	Code 128 Fixed Length 2	6-207
Additional Functions	3-7	Code 128 Label ID	6-202
Addons	6-155	Code 128 Length Control	6-203
AIM Formats	F-10	Code 128 Maximum Label Length	6-204
Automatic Zero Maintenance	1-7	Code 128 Minimum Label Length	6-205
Automatic Zero Setting Test	5-3	Code 128 Stitching	6-208
Aux Port Mode	6-45	Code 128 Supplemental	F-12
Bar Codes Supported	1-14	Code 128 Transmit Function Characters	6-199
Blanking Test	5-11	Code 128	F-8
Blanking Test	5-16	Code 39 AIM ID	6-186
Bookland AIM ID	6-137	Code 39 Check Character Calculation	6-183
Bookland Label ID	6-138	Code 39 Check Character Transmission	6-184
Bookland	F-12	Code 39 Enable	6-181
Cable Pinout	B-2	Code 39 Fixed Length 1	6-191
Cable Pinout	B-3	Code 39 Fixed Length 2	6-192
Cable Pinout	B-4	Code 39 Full ASCII	6-185
Cable Pinout	B-5	Code 39 Label ID	6-187
Cable Pinout	B-6	Code 39 Length Control	6-188
Cable Pinout	B-7	Code 39 Maximum Label Length	6-189
Cable Pinout	B-8	Code 39 Minimum Label Length	6-190
Cable Pinout	B-8	Code 39 Start Stop Character Transmission	6-182
Cables & Connections	2-22	Code 39 Stitching	6-193
Calibrating the Scale (Pounds & Kilograms)	5-4	Code 39	F-12
Calibrating the Scale	3-8	Code 39	F-7
Calibration Verification (Kilograms)	5-13	Code 39-Pharmacode	F-7
Calibration Verification (U.S. Pounds)	5-8	Code 93 AIM ID	6-239
Changing Weighing Modes	2-29	Code 93 Enable	6-238
Checkstand Design	2-3	Code 93 Fixed Length 1	6-244
Checkstand Mounting	2-17	Code 93 Fixed Length 2	6-245
Checkstand Preparation	2-10	Code 93 Label ID	6-240
Codabar AIM ID	6-230	Code 93 Length Control	6-241
Codabar Check Character Calculation	6-228	Code 93 Maximum Label Length	6-242
Codabar Check Character Transmission	6-229	Code 93 Minimum Label Length	6-243
Codabar Enable	6-223	Code 93 Stitching	6-246
Codabar Fixed Length 1	6-235	Code 93	F-13
Codabar Fixed Length 2	6-236	Code 93	F-9
Codabar Label ID	6-231	Connectors	1-5
Codabar Length Control	6-232	Convert Code128 to Code 39	6-200
Codabar Maximum Label Length	6-233	Counter Cutout	2-11
Codabar Minimum Label Length	6-234	Customizing Your Scanner's Operation	6-2
Codabar Start Stop Character Match	6-227	Datalogic Handheld Data Format Requirements	F-2
Codabar Start Stop Character Set	6-225	Decreasing-Load Test	5-12
Codabar Start Stop Character Transmission	6-224	Decreasing-Load Test	5-17
Codabar Stitching	6-237	Description of Calibration Sequence	5-2
Codabar	F-13	Diagnostic Mode	3-7
Codabar	F-8	Diagnostic Modes	2-21
Code 128 / EAN128	F-15	Diagnostic Procedures	4-2
Code 128 AIM ID	6-201	Diagnostic Tests	4-2

Double Read Timeout	6-11	Grounding	2-9
EAN 128 AIM ID.....	6-210	GTIN 2-Digit Supplemental Label ID.....	6-162
EAN 128 Label ID.....	6-211	GTIN 5-Digit Supplemental Label ID.....	6-163
EAN 13 Label ID.....	6-133	GTIN Code 128 Supplemental Label ID.....	6-164
EAN 8 Label ID.....	6-142	GTIN Enable.....	6-160
EAN-128 Enable.....	6-209	GTIN Label ID	6-161
EAN-13 128 Supplemental Label ID	6-136	Handheld Data Format Requirements General	F-1
EAN-13 2-Digit Supplemental Label ID.....	6-134	Horizontal Scan Window Replacement (WRG).....	3-13
EAN-13 5-Digit Supplemental Label ID.....	6-135	How to Use This Manual.....	1-3
EAN-13 Check Character Transmission	6-131	I 2 of 5 AIM ID.....	6-215
EAN-13 Enable.....	6-129	I 2 of 5 Check Character Calculation	6-213
EAN-13 First Character Transmission	6-130	I 2 of 5 Check Character Transmission	6-214
EAN-13 ISBN Conversion Enable	6-132	I 2 of 5 Fixed Length 1	6-220
EAN-13 with 2-Digit Supplemental.....	F-6	I 2 of 5 Fixed Length 2	6-221
EAN-13 with 5-Digit Supplemental.....	F-6	I 2 of 5 Label ID	6-216
EAN-13 with Code 128 Supplemental.....	F-6	I 2 of 5 Length Control.....	6-217
EAN-13	F-10	I 2 of 5 Maximum Label Length	6-218
EAN-13	F-6	I 2 of 5 Minimum Label Length	6-219
EAN-8 128 Supplemental Label ID	6-145	I 2 of 5 Stitching.....	6-222
EAN-8 2-Digit Supplemental Label ID.....	6-143	I 2 of 5	F-14
EAN-8 5-Digit Supplemental Label ID.....	6-144	I 2 of 5	F-7
EAN-8 Check Character Transmission	6-140	IBM Features	6-61
EAN-8 Decoding Levels.....	6-146	IBM Interface Options.....	6-61
EAN-8 Enable.....	6-139	IBM Port 17 Interface Selection.....	6-53
EAN-8 with 2-Digit Supplemental.....	F-5	IBM Scale Address	6-62
EAN-8 with 5-Digit Supplemental.....	F-5	IBM Transmit Labels in Code 39 Format	6-64
EAN-8 with Code 128 Supplemental.....	F-5	IBM USB Interface Options	6-65
EAN-8	F-10	IBM USB Interface Selection	6-54
EAN-8	F-5	IBM USB Scanner Device Type.....	6-67
EAS Active State	6-43	If You Make a Mistake.....	6-9
EAS Timeout	6-44	Increasing- Load Test (Phase 2).....	5-11
Electrical Specifications	1-9	Increasing- Load Test (Phase 2).....	5-15
Enable EAN Two Label	6-154	Increasing-Load Test (Phase 1).....	5-13
Entering and Exiting Programming Mode.	6-4	Increasing-Load Test (Phase 1).....	5-9
Ergonomic References.....	2-4	Installation Overview	2-17
Error Codes.....	4-3	Installation	2-31
Error Reporting.....	3-5	Integrating the Scanner With Your Host System.....	6-1
Expand EAN-8 to EAN-13	6-141	Interface Related Features	6-48
Expand UPC-A to EAN-13	6-114	Interface Type.....	6-48
Expand UPC-E to EAN-13.....	6-124	Interleaved 2 of 5 (I 2 OF 5) Enable	6-212
Expand UPC-E to UPC-A	6-123	Introduction to Label Programming.....	6-1
Flowcharts.....	4-8	Labeling.....	1-12
General Scanner and Scale Features.....	6-11	Laser and Product Safety	1-10
Global Prefix.....	6-57	Laser Timeout.....	6-13
Global Suffix.....	6-59	LED and Beeper Indicators	6-9
Good Read Beep Control.....	6-23	Lighting Considerations.....	2-24
Good Read Beep Frequency.....	6-24	Liquid Spills and Moisture	2-10
Good Read Beep Length	6-26	Manual Conventions.....	1-3
Good Read Beep Volume.....	6-27	Manual Overview.....	1-2
Good Read When to Indicate	6-30	Maximum Host-Transmitted Message Length	6-55
Green LED Idle State.....	6-18	Maximum Static Weight (Overload).....	1-6

Minimum Increment	1-6	Proper Scanning Technique	3-2
Motion Test.....	5-3	Proper Weighing Technique	3-3
Motor Timeout.....	6-15	Rated Weight Capacity	1-6
MSI/Plessey AIM ID.....	6-251	Remote Display — Enable/Disable.....	6-42
MSI/Plessey Check Character Calculation	6-248	Remote Scale Display Placement/Installation	2-24
MSI/Plessey Check Character Transmission.....	6-250	Return to Factory Settings.....	6-9
MSI/Plessey Enable.....	6-247	Return to Zero Test	5-12
MSI/Plessey Fixed Length 1	6-256	Return to Zero Test	5-17
MSI/Plessey Fixed Length 2	6-257	RS-232 ACK Character	6-90
MSI/Plessey Label ID.....	6-252	RS-232 ACK NAK Enable.....	6-88
MSI/Plessey Length Control	6-253	RS-232 ACK NAK Error Handling	6-95
MSI/Plessey Maximum Label Length.....	6-254	RS-232 ACK NAK Retry Count.....	6-94
MSI/Plessey Minimum Label Length	6-255	RS-232 ACK NAK Timeout Value.....	6-93
MSI/Plessey Number of Check Characters.....	6-249	RS-232 Baud Rate	6-68
MSI/Plessey Stitching.....	6-258	RS-232 Beep After Weigh.....	6-86
MSI/Plessey.....	F-13	RS-232 Beep on ASCII BEL.....	6-85
MSI/Plessey.....	F-9	RS-232 Beep on Not on File.....	6-87
Normal Operation	3-6	RS-232 Features.....	6-68
Number of Host Transmission Buffers.....	6-56	RS-232 Hardware Control	6-76
Operating Mode	3-6	RS-232 Host Echo Quiet Interval	6-81
Operational Configuration.....	3-5	RS-232 Host Echo	6-80
Operational Controls	3-4	RS-232 Ignore Host Commands.....	6-82
Operational Maintenance.....	3-10	RS-232 Intercharacter Delay	6-78
Operational Modes	3-4	RS-232 Interface Selection	6-50
Operational Tests.....	4-1	RS-232 Label ID Control	6-97
Operational Verification	2-19	RS-232 NAK Character	6-91
Other UPC/EAN Options	6-149	RS-232 Number of Data Bits.....	6-72
PDF417	F-15	RS-232 Number of Stop Bits	6-73
PDF417.....	F-9	RS-232 Parity	6-74
Pharmacode 39 Check Character Transmission	6-196	RS-232 Retry on ACK NAK Timeout	6-92
Pharmacode 39 Enable.....	6-194	RS-232 Single Cable Interface Selection.....	6-52
Pharmacode 39 Label ID	6-197	RS-232 Software Flow Control	6-79
Pharmacode 39 Start Stop Character Transmission	6-195	RS-232 TTL Invert.....	6-84
Physical Parameters	1-6	RS-232 TTL	6-83
Placing and Installing the Remote Scale Display	2-26	RS-232 Wincor-Nixdorf Interface Selection.....	6-51
Power Installation	2-9	RSS Expanded 2D Component Enable.....	6-173
Power Supply	1-9	RSS Expanded AIM ID.....	6-174
Power-up Beep Control.....	6-21	RSS Expanded EAN-128 Emulation.....	6-172
Power-Up Selftest	4-1	RSS Expanded Enable.....	6-171
Power-up	1-7	RSS Expanded Fixed Length 1	6-179
Power-Up/Selftest & Pre-Operation	3-4	RSS Expanded Fixed Length 2.....	6-180
Power-Up/Selftest	3-4	RSS Expanded Label ID.....	6-175
Pre-Installation Considerations	2-2	RSS Expanded Length Control	6-176
Preparing the Scanner/Scale for Calibration	5-4	RSS Expanded Maximum Label Length.....	6-177
Price Weight Check	6-151	RSS Expanded Minimum Label Length.....	6-178
Productivity Index Reporting (PIR)	6-47	RSS Expanded	F-14
Programming Overview	6-3	RSS Expanded	F-2
Programming Sequence.....	6-7	RSS-14 2D Component Enable.....	6-168
Programming Session.....	6-5	RSS-14 AIM ID.....	6-169
Programming via Handheld Device	6-3	RSS-14 Check Character Transmission.....	6-166
Programming.....	3-7	RSS-14 Enable.....	6-165

RSS-14 Label ID.....	6-170	System Power-Up Recap.....	2-33
RSS-14.....	F-14	Test Mode.....	6-10
RSS-14.....	F-2	Thermal Equilibrium.....	1-7
RSS-14/EAN-128 Emulation.....	6-167	Understanding the Basics.....	6-1
Scale Adjustments.....	3-8	Unpacking.....	2-17
Scale Country Mode.....	6-33	UPC/EAN AIM ID.....	6-115
Scale Diagnostic Mode.....	2-22	UPC/EAN Reconstruction.....	6-150
Scale Enable.....	6-32	UPC-A 128 Supplemental Label ID.....	6-119
Scale Enforced Zero Return.....	6-35	UPC-A 2-Digit Supplemental Label ID.....	6-117
Scale Error Reporting.....	4-6	UPC-A 5-Digit Supplemental Label ID.....	6-118
Scale Interface Type.....	6-37	UPC-A and EAN-13 Decoding Levels.....	6-157
Scale LED Enable.....	6-41	UPC-A Check Character Transmission.....	6-113
Scale Motion Level Filter.....	6-39	UPC-A Enable.....	6-111
Scanner and Scale Reset.....	3-7	UPC-A Label ID.....	6-116
Scanner and Scanning-Scale Nomenclature.....	1-4	UPC-A Number System Character Transmission.....	6-112
Scanner Button Options.....	6-19	UPC-A with 2-Digit Supplemental.....	F-2
Scanner Diagnostic Mode.....	2-21	UPC-A with 5-Digit Supplemental.....	F-3
Scanner Installation.....	2-4	UPC-A with Code 128 Supplemental.....	F-3
Scanner Maintenance.....	2-4	UPC-A.....	F-10
Scanner Usage.....	2-4	UPC-A.....	F-2
Scanning Items.....	3-1	UPC-E 128 Supplemental Label ID.....	6-128
Scanning.....	1-6	UPC-E 2-Digit Supplemental Label ID.....	6-126
Service Access.....	2-8	UPC-E 5-Digit Supplemental Label ID.....	6-127
Set Single Cable RS-232 ETX Character.....	6-109	UPC-E Check Character Transmission.....	6-122
Set Single Cable RS-232 STX Character.....	6-107	UPC-E Enable.....	6-120
Set-Up & Installation.....	2-29	UPC-E Label ID.....	6-125
Set-up.....	2-29	UPC-E Number System Character Transmission.....	6-121
Shift Test (Metric).....	5-14	UPC-E with 2-Digit Supplemental.....	F-4
Shift Test.....	5-9	UPC-E with 5-Digit Supplemental.....	F-4
Single Cable RS-232 Datalogic Extensions.....	6-110	UPC-E with Code 128 Supplemental.....	F-4
Single Cable RS-232 Options.....	6-99	UPC-E.....	F-10
Single Cable RS-232 RTS CTS Selection.....	6-101	UPC-E.....	F-3
Single Cable RS-232 Scanner Only Protocol.....	6-100	User Configurable Warm-up.....	1-7
Single Cable RS-232 Use ACK/NAK.....	6-105	Ventilation and Spacing.....	2-7
Single Cable RS-232 Use BCC.....	6-104	Vertical Scan Window Replacement.....	3-11
Single Cable RS-232 Use ETX.....	6-108	Viewing Angle.....	2-25
Single Cable RS-232 Use STX.....	6-106	Warm-Up Time.....	1-7
Site Preparation Overview.....	2-5	Weighing.....	1-6
Sleep Mode.....	3-6	What Is Programming Mode?.....	6-4
Standard 2 of 5 AIM ID.....	6-262	Zeroing the Scale.....	3-8
Standard 2 of 5 Check Character Calculation.....	6-260		
Standard 2 of 5 Check Character Transmission.....	6-261		
Standard 2 of 5 Enable.....	6-259		
Standard 2 of 5 Fixed Length 1.....	6-267		
Standard 2 of 5 Fixed Length 2.....	6-268		
Standard 2 of 5 Label ID.....	6-263		
Standard 2 of 5 Length Control.....	6-264		
Standard 2 of 5 Maximum Label Length.....	6-265		
Standard 2 of 5 Minimum Label Length.....	6-266		
Standard 2 of 5 Stitching.....	6-269		
Symbology Programming.....	6-111		

ASCII Character Set

The table on this page shows a set of ASCII characters and their corresponding Hex Values. The Hex Values in this table are needed for setting symbology specific label identifiers, as well as enabling custom prefix and suffix characters.

ASCII Char.	Hex No.	ASCII Char.	Hex No.	ASCII Char.	Hex No.	ASCII Char.	Hex No.
NUL	00	SP	20	@	40	'	60
SOH	01	!	21	A	41	a	61
STX	02	"	22	B	42	b	62
ETX	03	#	23	C	43	c	63
EOT	04	\$	24	D	44	d	64
ENQ	05	%	25	E	45	e	65
ACK	06	&	26	F	46	f	66
BEL	07	'	27	G	47	g	67
BS	08	(28	H	48	h	68
HT	09)	29	I	49	i	69
LF	0A	*	2A	J	4A	j	6A
VT	0B	+	2B	K	4B	k	6B
FF	0C	,	2C	L	4C	l	6C
CR	0D	-	2D	M	4D	m	6D
SO	0E	.	2E	N	4E	n	6E
SI	0F	/	2F	O	4F	o	6F
DLE	10	0	30	P	50	p	70
DC1	11	1	31	Q	51	q	71
DC2	12	2	32	R	52	r	72
DC3	13	3	33	S	53	s	73
DC4	14	4	34	T	54	t	74
NAK	15	5	35	U	55	u	75
SYN	16	6	36	V	56	v	76
ETB	17	7	37	W	57	w	77
CAN	18	8	38	X	58	x	78
EM	19	9	39	Y	59	y	79
SUB	1A	:	3A	Z	5A	z	7A
ESC	1B	;	3B	[5B	{	7B
FS	1C	<	3C	\	5C		7C
GS	1D	=	3D]	5D	}	7D
RS	1E	>	3E	^	5E	~	7E
US	1F	?	3F	_	5F	DEL	7F

Australia

Datalogic Scanning Pty Ltd
North Ryde, Australia
Telephone: [61] (2) 9870 3200
Fax: [61] (2) 9878 8688

Japan

Datalogic Scanning KK
Shinagawa, Tokyo, Japan
Telephone: 81 (0)3 3491 6761
Fax: 81 (0)3 3491 6656

France and Benelux

Datalogic Scanning Sarl
LES ULIS Cedex, France
Telephone: [33].01.64.86.71.00
Fax: [33].01.64 46.72.44

Latin America

Datalogic Scanning, Inc
Miami, Florida, USA
Telephone: (305) 591-3222
Fax: (305) 591-3007

Germany

Datalogic Scanning GmbH
Darmstadt, Germany
Telephone: 49 (0) 61 51/93 58-0
Fax: 49 (0) 61 51/93 58 58

Spain and Portugal

Datalogic Scanning Sarl Sucursal
en España
Madrid, Spain
Telephone: 34 91 746 28 60
Fax: 34 91 742 35 33

Italy

Datalogic Scanning SpA
Vimercate (MI), Italy
Telephone: [39] (0) 39/62903.1
Fax: [39] (0) 39/6859496

United Kingdom

Datalogic Scanning LTD
Watford, England
Telephone: 44 (0) 1923 809500
Fax: 44 (0) 1923 809 505



www.scanning.datalogic.com

Datalogic Scanning, Inc.

959 Terry Street
Eugene, OR 97402
Telephone: (541) 683-5700
Fax: (541) 345-7140

